



# LIBERTY'S PRO AV PRODUCTS & SOLUTIONS

Providing one of the broadest ranges of professional AV products available, Liberty AV Solutions has evolved from being one of the world's premier suppliers of wire and cable into a solutions-based company known for its wide ranging product offering and stellar customer service.

We continue to lead the industry with our standard and break-through products of bulk & pre-made cable, connectors, plates and tools but also offer power management and rack enclosures, plus an entire line of digital devices when Intelix became part of the Liberty family in 2011.

**With the combination of Pro AV products and our extensive top-notch Liberty Edge services, we can't be beat! RUN WITH US & put our powerhouse of products to work for you today.**



**Liberty Wire & Cable** is a leading brand within the professional AV marketplace providing high quality wire & cable products. Our full range of bulk and pre-made cable offerings make it easy to get everything you need in one place.

- BULK CABLE
- CUSTOM ASSEMBLED CABLES
- PRE-MADE CABLES
- HDMI CABLE SOLUTIONS
- CONNECTORS & ADAPTERS
- INSTALLATION ACCESSORIES
- PROFESSIONAL TOOLS
- POWER MANAGEMENT



**Intelix Digital & Analog Devices** provide reliable solutions for switching, scaling, extending and distributing signals for both commercial and residential applications. Solve your analog-to-digital challenges and improve your profitability.

- DISTRIBUTED DIGITAL SYSTEMS
- COAXIAL EXTENDERS
- DISTRIBUTED ANALOG SYSTEMS
- DISTRIBUTION AMPLIFIERS & SPLITTERS
- FORMAT CONVERTERS & SCALERS
- MATRIX SWITCHERS
- TWISTED PAIR EXTENDERS
- WIRELESS DISTRIBUTION SYSTEMS



**PanelCrafters Plates & Panels** provide high quality connectivity products in demand by AV professionals. We also specialize in custom designed plates and panels that you can create online 24/7 with our exclusive WebBlox online software.

- CUSTOM PLATE & PANELS
- AUDIO & VIDEO
- BALUN & CLASSROOM PLATES
- COMBO & DATA PLATES
- DIGITAL & GROMMET PLATES
- MIC PLATES
- USB & VGA PLATES
- KEYSTONE INSERTS & PLATES



You can trust **Fibertron Custom Fiber Optics** to meet your most challenging point-to-point cabling needs. In performance, configuration, labeling and packaging, we have prestigious industry certifications in virtually every major marketplace.

- CUSTOM FIBER INSTALL CABLES
- CUSTOM FIBER PATCH CORDS
- DATA CENTER CONFIGURATIONS
- LEMO® BROADCAST CABLES
- PRO A/V CONFIGURATIONS
- STANDARD FIBER PATCH CORD
- FIBER CONNECTORS
- CORNING TERMINATION TOOLS



1991

Liberty Wire & Cable is founded

1992

Liberty creates and launches the bulk cable color standards now used in the entire industry  
ExtraFlex System Cabling launched

1995

Value add printing & Spool Easy boxes launch

1997

Opened Charlotte North Carolina distribution branch

1998

Launched custom assembly operations

1999

Launched broadcast product line  
Introduced Mini-High Resolution RGB cables  
Partnerships with AMX, Crestron, Lutron, Lite-Touch, ADA Millenium, Meridian supplying OEM cables  
Introduces compression connectors to the A/V market



# THE LIBERTY EDGE - EXTEND YOUR WORKFORCE!

**Get The Edge**

Leverage our services as an extension of your workforce! Your business needs a competitive edge, and that's where we come in. Consolidate purchases, save time, labor and improve your profitability by putting the expansive Liberty Edge services to work for you!



**VALUE INCENTIVE REBATES**

The more you spend the more you save!  
Take advantage and get money back

**TRY & BUY PROGRAM**

Get 20% off on any first time product you want to try

**CUSTOM FIBER ASSEMBLIES**

Protect intellectual property and save time with custom copper and assemblies

**PROJECT STAGING SERVICES**

Off-site staging program that palletizes, labels, and ships complete to your site

**CUSTOM KITTING**

Streamline your installs with a pre-packaged kit of everything you need

**REFERENCE TOOLS**

Wire schedules, cross reference tools and conduit master fill software

**COOL SPOOL SYSTEM\***

Our exclusive reel box system allows for transport and tangle-free pulls

**CUSTOM CABLE PRINTING**

Print your cable with your contact info so the customers remember you

**CUSTOM PLATE DESIGN**

Print dealer logo and contact info to get advertising and repeat business

**LIBERTY INVENTORY SERVICES**

On-site consigned inventory management reduces procurement and carrying costs

**CUSTOM PLATES PRINTING**

Print dealer logo and contact info to get advertising and repeat business

**CUSTOM CABLE BUNDLING**

Save labor time with custom cable bundling and proprietary part number

**CUSTOM CABLE COLORING**

Identify cables more easily to increase efficiency and make installs easier

**CONTRACT BILLING**

Orders are streamlined so you have less costs and fewer headaches

**CUSTOM CABLE CUTTING**

Save labor time by getting cable pre-cut to any length.

**LEARNING CENTER**

Product training videos are available at [www.LibAV.com](http://www.LibAV.com)

**PRO TERMINATION TOOLS**

Our termination tools are proven to save almost 2/3rds of your time

**THE EDGE ONLINE**

Our leading-edge website provides fast quoting, ordering, history, & more



**2002**

**2005**

**2006**

**2007**

**2011**

**2012**

**2013**

Acquired PanelCrafters and Specialty Printed Products  
Launched EZ-LINX modular interconnection system

Liberty Wire & Cable sold to River Group Investments  
Liberty Inventory Services launched (LIS)

Liberty Wire & Cable acquired by Communication Supply Specialties (CSC)  
CSC is acquired by WESCO Distribution

Liberty carries FiberTron products

Liberty acquires Intelix Analog & Digital Devices  
Celebrates 20 years in business

Changes name to Liberty AV Solutions  
Launches HD Termination System for field-terminated HDMI cables

Becomes a leader application-based solutions like HDBaseT technology  
Launches locking & Fiber HDMI



# CABLE: BULK Page 5



- Bulk Cable Intro ..... 6
- Analog Audio Bulk..... 7-9
- Analog Video Bulk..... 10-16
- Category/LAN/Data Bulk..... 17-22
- Digital Audio Bulk ..... 23
- Digital Video Bulk ..... 25-28
- HDMI Bulk..... 29-31
- Lighting Control Bulk ..... 32-43
- Multi-Purpose Bulk..... 45-57
- RF Video Bulk ..... 58-63
- Security Bulk ..... 63
- Speaker Audio Bulk ..... 64-73
- Structured Bulk..... 74-76
- Wireless Broadcast Bulk ..... 77-78
- NEC Cable Substitution & Hierarchy Chart..... 79
- Residential Wire Schedule..... 80-81
- Commercial Plenum Wire Schedule ..... 81-82
- Commercial Non-Plenum Wire Schedule ..... 82-83
- 75 OHm Transmission Chart..... 84

# CABLE: PREMADE Page 85



- Audio Premade ..... 86-89
- Audio/Video Premade..... 90-91
- Category/LAN/Data Patch ..... 92
- DVI Premade..... 93-94
- Data & Control Premade ..... 95
- EZ-LINX Premade ..... 96-99
- EZ2-LINX Premade ..... 100-101
- HDMI Patch ..... 102-106
- S-Video Premade..... 107
- USB Premade..... 108
- VGA Premade ..... 109-113
- Video Premade ..... 114-116

# CONNECTORS & ADAPTORS Page 117



1/8" & 1/4" .....	118-119
BNC.....	120-124
D-SUB.....	125-129
F.....	130-131
Fiber Optic .....	131
HDMI.....	132-133
RCA .....	134-135
RJ45/LAN .....	136-138
S-Video .....	138
Speaker/Audio C-Tec <sup>2</sup> .....	139
Speaker/Speakon .....	140
TNC/XLR .....	141-142

# INTELIX SIGNAL MANAGEMENT Page 143



Intelix Intro.....	144-145
Distribution Amplifiers .....	146-151
Extenders/Baluns.....	152-177
HDMI Extender Reference Guide.....	178
Matrix Switchers .....	179-189
Accessories.....	190-191
Test Equipment.....	192

# FIBER OPTIC SOLUTIONS Page 193

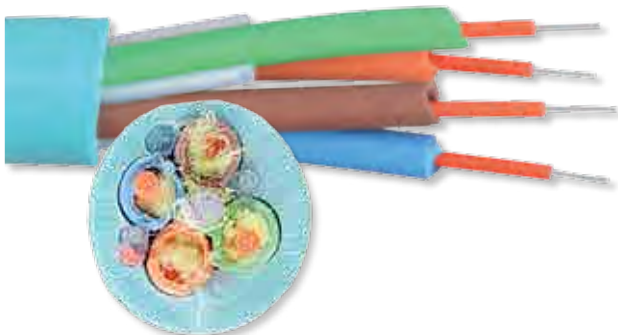

Fiber Optic Intro .....	194
Fiber Optic Bulk & Custom Cable.....	195-197
Fiber Optic Termination Tools & Connectors .....	198-199
Fiber Optic HDMI Solution.....	200
Fiber Optic Patch Cords .....	201-206
Fiber Optic Patch Panels.....	207-209
Fiber Optic Enclosures.....	210

# PANELCRAFTERS PLATES, PANELS AND INSERTS Page 211



Services that Add Value..... 212  
 Design & Quoting Software Tools..... 213  
 Quotes and Up-Front Proofing.....214  
 Plate & Panel Surface Finishes ..... 215  
 Prewired Plates & Panels.....216  
 Custom Plate Sizes..... 217  
 Custom Plates & Panels .....218  
 Rack Headers, RHCB & RHIM .....219  
 Alternative Gang Plate Options..... 220  
 Stock Plates & Part Number Key ..... 221  
 Stock Plates..... 222-227  
 Faceplates & Inserts..... 228-234

# POWER PROTECTION Page 235-238



# RACKS & ACCESSORIES Page 239

SnapRax Series Overview..... 240  
 SnapRax Series Frames .....241-242  
 SnapRax Series Accessories.....243-246



# TOOLS & ACCESSORIES Page 247



C-TEC<sup>2</sup> Strippers, Crimpers & Dies ....248-250  
 Colored MHR Strain Relief Boots..... 250  
 Crimp Tool for D-Sub Connectors ..... 251  
 Strip Tool for Mini High Res Coax Cable ... 251  
 Paladin Cable Strip Tool ..... 251  
 Amphenol Connex Crimp Tools ..... 251  
 Amphenol Connex Crimp Dies..... 252  
 CoolSpool<sup>®</sup> Hand Truck & System ..... 253  
 CatMster<sup>®</sup> Termination Tools ..... 254-255  
 Colored RJ45 Strain Relief Boots..... 255  
 HD Termination Crimp Tool..... 255  
 Fiber Optic Termination..... 256  
 Heat Shrink & Techflex<sup>®</sup> Tubes .....256-257  
 Installer's Choice Wall Boxes ..... 258  
 Cable Ties ..... 258

# ALPHABETICAL INDEX Page 260



**Liberty**  
WIRE & CABLE

**BULK WIRE & CABLE**

**RUN WITH US**

Gary Michelson founded Liberty Wire & Cable in 1991 with only a receptionist, a plan and a dream. He successfully started selling bulk cable and within a year was growing his staff as well as his reputation for quality products.

Soon a house remodeling project presented Gary with his first revolutionary product innovation. In every room he saw many cables for many uses but all with the same color which made it time-consuming and difficult for installers to keep track of their cables.

Why not, he thought, differentiate cable function with different colors. Soon an industry standard was born. Liberty infamously went national with colored cable at the very next CEDIA Expo and created a hit not just for the genius of its color coding, but also its durable, flexible, easy-to-pull jacket.

By 1998 Liberty started exporting products and continued to grow. Building on success, Liberty widened its cable product range with pre-mades, connectors, custom and stock plates & panels, tools, racks, and power management solutions.

A big milestone for Liberty was entering the broadcast market and rising quickly in prominence to become a trusted cable supplier for World Cup Skiing in 2000 and 2001 and for the Olympics in 2002.

In 2010 Liberty Wire & Cable became Liberty AV Solutions which kept the well respected brand of Liberty Wire & Cable for their cable products but allowed easy expansion into digital solutions. Now Liberty AV Solutions carries several brands of Professional Installation products and services like plates, panels, analog and digital devices, and even rack and power management solutions.

Staying true to its origins, today Liberty continues to develop and broaden its line of cable in order to better provide installers with the products required to get every job done right and on time. Beyond a steady stream of new innovations, Liberty offers a number of value-added services and customer-focused solutions that make it the only logical choice when it comes time to choose a full-service business partner.





## ANALOG AUDIO

“Liberty’s analog audio cable selection offers a wide range to choose from. Our top of the line Broadcast quality twisted shielded EZ strip low capacitance series has the lowest capacitance of any like cable. The residential shielded EX series is built like a tank to withstand the rigors of heavy pulling and sharp corners. The X-Cross Mic cable is durable, flexible, and UL listed for hard install and tactical use.”



### Analog Audio: Non-Plenum Cables

Liberty’s definition of non-plenum cable is basically no plenum. We have the following levels grouped under non-plenum so please pay attention to the ratings you need and require:

**RISER:** Signified by the suffix “R” after the article code. These include CL2R, CL3R, CMR, OFNR. The Riser rating indicates the cable has passed the UL1666 flame test. Riser rated cables are backwards compatible to general purpose and limited use cables and Riser ratings are permissible for substitution per the National Electric Code®. Riser rated products can go between floors in commercial building risers as long as there is no environmental air or air handling in those spaces. Riser ratings are authorized for in-wall use.

**GENERAL PURPOSE:** There are two levels of general purpose ratings. Ratings with a suffix of “G” after the article code are certified to the Canadian FT4 flame test. An example is a rating of CMG. If there is no rating suffix at all, such as CL2, CL3, CM, or

OFN then the cable has passed the US UL1685 vertical flame test. General purpose cables are backwards compatible to limited use cables. General purpose ratings are good for single floor use. They cannot be routed between floors except in 1 and 2 family residences.

**LIMITED USE:** Liberty generally does not stock or sell limited use cables. These are signified by a suffix of “X” after the article code. CL2X, CL3X, CMX for example. These are limited to 1 and 2 story, 1 and 2 family residences. They can be used in commercial spaces but only in approved conduit.

**OUTSIDE PLANT:** Also called OSP for short. This is product that has been certified for use in sunlight exposed and direct burial applications outdoors. Liberty OSP products meet all UL requirements for Sunlight Resistance and Direct Burial applications. The products have been tested for UL’s crush resistance. At Liberty, we ensure compliance to all code requirements.

#### HIGH-PERFORMANCE EZ-STRIP BROADCAST AUDIO 22 AWG 1 PAIR SHIELDED CABLE

**Broadcast Quality  
NON-PLENUM**



**Features & Benefits:**

- 7 strand annealed tinned copper conductors
- Cellular polyethylene dielectric insulation
- Tightly twisted & shielded
- Semi pressure extruded PVC jacket
- Shield bonded to the jacket for EZ-Stripping
- NEC CM, CEC CMG FT4, RoHS compliant
- 1000 foot spools

**22-1P-EZ**

**Application:**

- Line level, microphone audio
- Balanced and unbalanced audio formats
- Infrared (IR), RS-232C signaling
- Class 2 and Class 3 low voltage power
- Instrumentation and control



**New Website**  
[www.LibAV.com](http://www.LibAV.com)  
**BETTER, STRONGER,  
EXPANSIVE!**

NOM OD (INCHES): 0.155	AWG SIZE: 22	# OF PAIRS: 1	# OF CONDUCTORS 2	AVAILABLE JACKET COLORS: PART NUMBER COLOR ID:	● BLK ● GRY ● WHT ● BLU ● PUR ● RED ● YEL
---------------------------	-----------------	------------------	----------------------	---	---

#### HIGH-PERFORMANCE EZ-STRIP BROADCAST AUDIO 22 AWG 2 PAIR SHIELDED CABLE

**Broadcast Quality  
NON-PLENUM**



**Features & Benefits:**

- 7 strand annealed tinned copper conductors
- Cellular polyethylene dielectric insulation
- Tightly twisted & shielded
- Semi pressure extruded PVC jacket
- Shield bonded to the jacket for easy stripping
- Zipcord style (SPT) two shielded cables in parallel
- NEC CM, CEC CMG FT4, RoHS compliant
- 1000 foot spools

**22-2P-SIAM-EZ**

**Application:**

- Line level, microphone audio
- Balanced and unbalanced audio formats
- Infrared (IR), RS-232C signaling
- Class 2 and Class 3 low voltage power
- Instrumentation and control

NOM OD (INCHES): .135X.285	AWG SIZE: 22	# OF PAIRS: 2	# OF CONDUCTORS 4	AVAILABLE JACKET COLORS: PART NUMBER COLOR ID:	● BLK
-------------------------------	-----------------	------------------	----------------------	---	-------



## LIBERTY X-CROSS MICROPHONE 24 AWG 2 PAIR BRAID SHIELDED TACTICAL MICROPHONE AUDIO CABLE

**Microphone**  
NON-PLENUM



**Features & Benefits:**

- 41 strand tinned copper conductors
- Polyethylene dielectric insulation
- Pairs laid across a cotton core polar opposite each other
- Cotton fillers placed to space conductors evenly
- 100% paper tape binder stabilizing the core
- 95% tinned copper braided overall shield
- Super-Flex pressured PVC matte jacket
- NEC CM, CEC CM, RoHS compliant
- 1000 foot spools

**24-2P-STAR**

**Application:**

- Tactical and stage line level audio
- Balanced and unbalanced audio formats
- Microphone audio
- Instrumentation and control



**HDMI MOBILE ADAPTER RING GENIUS!**

See Page: 132

NOM OD (INCHES): 0.240	AWG SIZE: 24	# OF PAIRS: 2	# OF CONDUCTORS 4	AVAILABLE JACKET COLORS: ●
				PART NUMBER COLOR ID: BLK

## EXTRAFLEX® AUDIO AND CONTROL 22 AWG 2 PAIR INDIVIDUALLY SHIELDED CABLE

**Residential**  
NON-PLENUM

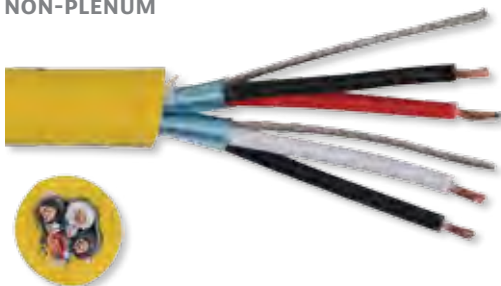

**Features & Benefits:**

- 16 strand annealed bare copper conductors
- Semi rigid PVC insulation
- Each pair twisted, shielded & isolated
- Semi pressure extruded PVC jacket
- NEC CM, CEC CMG FT4, RoHS compliant
- 1000 foot spools

**22-2P-SHEX**

**Application:**

- Line level, microphone audio
- Balanced and unbalanced audio formats
- Infrared (IR), RS-232C signaling
- Class 2 and Class 3 low voltage power
- Instrumentation and control

NOM OD (INCHES): 0.260	AWG SIZE: 22	# OF PAIRS: 2	# OF CONDUCTORS 4	AVAILABLE JACKET COLORS: ● ●
				PART NUMBER COLOR ID: PUR YEL

## Analog Audio: Plenum Cables

Plenum rated products have passed the highest flame test, NFPA-262. These products have a suffix of "P" after the article code. Some examples of the ratings you will find on the jacket are CL2P, CL3P, CMP, and OFNP. Plenum rated products can go between floors in commercial building where environmental air or air handling requirements exist for those spaces.

Other locations that will commonly call out Plenum requirements are the airspaces between drop ceilings and the actual construction. Plenum ratings are also authorized for in-wall use and plenum is backwards compatible for Riser, General Purpose, and Limited Use. Plenum rated product should never be used as OSP cable.

## HIGH-PERFORMANCE EZ-STRIP BROADCAST AUDIO 22 AWG 1 PAIR SHIELDED PLENUM CABLE

**Broadcast Quality**  
PLENUM



**Features & Benefits:**

- 7 strand annealed tinned copper conductors
- Cellular fluoropolymer dielectric insulation
- Tightly twisted & shielded
- Semi pressure extruded plenum PVC jacket
- Low capacitance broadcast audio
- NEC CMP, CEC CMP FT6, RoHS compliant
- 1000 foot spools

**22-1P-CMP-EZ**

**Application:**

- Line level, microphone audio
- Balanced and unbalanced audio formats
- Infrared (IR), RS-232C signaling
- Class 2 and Class 3 low voltage power
- Instrumentation and control

NOM OD (INCHES): 0.130	AWG SIZE: 22	# OF PAIRS: 1	# OF CONDUCTORS 2	AVAILABLE JACKET COLORS: ● ● ● ● ●
				PART NUMBER COLOR ID: BLK BLU WHT PUR GRN

## HIGH-PERFORMANCE EZ-STRIP BROADCAST AUDIO 22 AWG 2 PAIR SHIELDED PLENUM CABLE

**Broadcast Quality**  
**PLENUM**



**Features & Benefits:**

- 7 strand annealed tinned copper conductors
- Cellular FEP dielectric insulation
- Tightly twisted & shielded
- Semi pressure extruded plenum alloy jacket
- Foil Shield bonded to inside of jacket for EZ-Stripping
- SPT or ZIP-Style Construction with two legs in parallel
- NEC CMP, CEC CMP FT6, RoHS Compliant
- 1000 Foot Spools

**22-2P-CMP-SIAMEZ**

**Application:**

- Line level, microphone level audio
- Balanced and unbalanced audio formats
- Infrared (IR), RS-232C signaling
- Instrumentation and control

NOM OD (INCHES): .285X.135	AWG SIZE: 22	# OF PAIRS: 2	# OF CONDUCTORS 4	AVAILABLE JACKET COLORS: <input type="radio"/>	PART NUMBER COLOR ID: WHT
-------------------------------	-----------------	------------------	----------------------	--	---------------------------

## HIGH-PERFORMANCE EZ-STRIP BROADCAST AUDIO 24 AWG 1 PAIR SHIELDED PLENUM CABLE

**Broadcast Quality**  
**PLENUM**

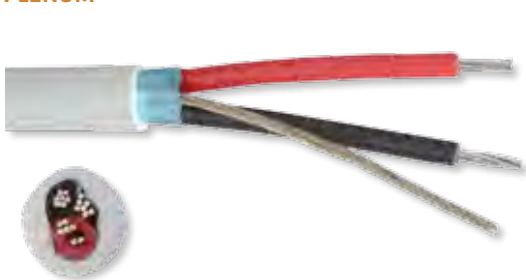

**Features & Benefits:**

- 7 strand annealed tinned copper conductors
- Cellular fluoropolymer dielectric insulation
- Tightly twisted & shielded
- Semi pressure extruded plenum PVC jacket
- Low capacitance broadcast audio
- NEC CMP, CEC CMP FT6, RoHS compliant
- 1000 foot spools

**24-1P-CMP-EZ**

**Application:**

- Line level, microphone audio
- Balanced and unbalanced audio formats
- Infrared (IR), RS-232C signaling
- Class 2 and Class 3 low voltage power
- Instrumentation and control

NOM OD (INCHES): 0.140	AWG SIZE: 24	# OF PAIRS: 1	# OF CONDUCTORS 2	AVAILABLE JACKET COLORS: <input type="radio"/>	PART NUMBER COLOR ID: WHT
---------------------------	-----------------	------------------	----------------------	--	---------------------------

# COOL SPOOL SYSTEM<sup>®</sup>

## TANGLE-FREE PULLS AND TOTAL CONTROL!

# THE LIBERTY EDGE



Tension control handle eliminates tangles, bird's nests and wasted cable.

Double-enforced construction means no torn handles and tough enough to withstand the most rigorous handling.

Multiple dispensing slots allow pulling cables through 2 or more boxes.



### OUR CUSTOM DESIGNED REEL BOX & HAND TRUCK ACCOMMODATE ANY TYPE OF INSTALLATION JOB!

Three standardized reel/boxes available to accommodate a variety of cables – Cat 5e/6, RG59/6 coax, mini-coax and speaker cable.

Tension-control side knobs eliminates tangles and wasted cable while our custom-designed hand truck with extendable toe converts from a dolly to a full-sized transportation cart in seconds.

**HANDTRUCK:  
SEE PAGE 253**



## ANALOG VIDEO

Liberty's base band video cable line supports all your security video needs. We use pure copper, no CCA or CCS conductors or braiding here. Combined with our compression connector series, this cable is ready for a fast quality install. This cable is also great for unbalanced audio on RCA plugs and is a choice for subwoofer input cables.



## Analog Video: Non-Plenum Cables

Liberty's definition of non-plenum cable is basically no plenum. We have the following levels grouped under non-plenum so please pay attention to the ratings you need and require:

**RISER:** Signified by the suffix "R" after the article code. These include CL2R, CL3R, CMR, OFNR. The Riser rating indicates the cable has passed the UL1666 flame test. Riser rated cables are backwards compatible to general purpose and limited use cables and Riser ratings are permissible for substitution per the National Electric Code®. Riser rated products can go between floors in commercial building risers as long as there is no environmental air or air handling in those spaces. Riser ratings are authorized for in-wall use.

**GENERAL PURPOSE:** There are two levels of general purpose ratings. Ratings with a suffix of "G" after the article code are certified to the Canadian FT4 flame test. An example is a rating of CMG. If there is no rating suffix at all, such as CL2, CL3, CM, or

OFN then the cable has passed the US UL1685 vertical flame test. General purpose cables are backwards compatible to limited use cables. General purpose ratings are good for single floor use. They cannot be routed between floors except in 1 and 2 family residences.

**LIMITED USE:** Liberty generally does not stock or sell limited use cables. These are signified by a suffix of "X" after the article code. CL2X, CL3X, CMX for example. These are limited to 1 and 2 story, 1 and 2 family residences. They can be used in commercial spaces but only in approved conduit.

**OUTSIDE PLANT:** Also called OSP for short. This is product that has been certified for use in sunlight exposed and direct burial applications outdoors. Liberty OSP products meet all UL requirements for Sunlight Resistance and Direct Burial applications. The products have been tested for UL's crush resistance. At Liberty, we ensure compliance to all code requirements.

### NO SKEW RGB VIDEO 23 AWG 4 PAIR U/UTP CABLE

Commercial  
NON-PLENUM

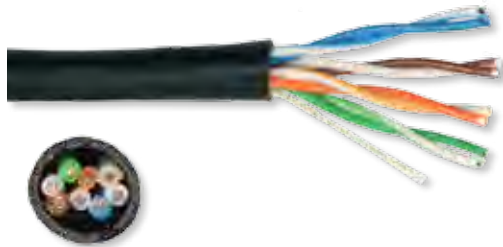

#### Features & Benefits:

- 23 AWG solid annealed bare copper conductors
- High density polyethylene dielectric insulation
- Pairs in identical lay lengths and cabled together
- Flame rated PVC jacket
- Inter pair skew maximum 2.0 nS/100m
- NEC CMR, CEC CMR FT4, RoHS compliant
- 1000 foot spools

#### TRUPHASE

##### Application:

- Analog base band video signals, security video
- RGB, RGBs, RGBHV over twisted pair systems infrastructure
- Infrared, non-TIA/EIA data



**New Website**  
[www.LibAV.com](http://www.LibAV.com)  
**BETTER, STRONGER, EXPANSIVE!**

NOM OD (INCHES): 0.192	AWG SIZE: 23	# OF PAIRS: 4	# OF CONDUCTORS 8	AVAILABLE JACKET COLORS: ● PART NUMBER COLOR ID: BLK
---------------------------	-----------------	------------------	----------------------	---

### RGB 5 X 23 AWG MINI-RG59 SDI COAXIAL VIDEO CABLE

Commercial  
NON-PLENUM

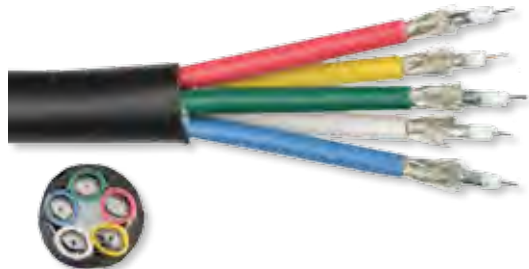

#### Features & Benefits:

- 23 AWG solid annealed bare copper conductor
- Gas injected cellular polyethylene dielectric
- 100% coverage aluminum/poly/aluminum foil inner shield
- 95% coverage tinned copper braid shield
- Flame rated PVC jacket
- 5 coaxial cables jacketed together
- 3.0 GHz sweep, very low loss, excellent SRL
- NEC CMR, CEC CMR FT4, RoHS compliant
- 1000 foot spools

#### RGB5C-23-CM

##### Application:

- SMPTE serial digital video, AES3id digital audio
- S/PDIF digital audio, subwoofer audio
- All base band video and unbalanced analog audio
- RF modulated signals, CATV, DBS, MATV

NOM OD (INCHES): 0.550	AWG SIZE: 23	# OF PAIRS: N/A	# OF CONDUCTORS 5	AVAILABLE JACKET COLORS: ● PART NUMBER COLOR ID: BLK
---------------------------	-----------------	--------------------	----------------------	---

## RGB 5 X 20 AWG RG59 SDI COAXIAL VIDEO CABLE

**Commercial**  
NON-PLENUM

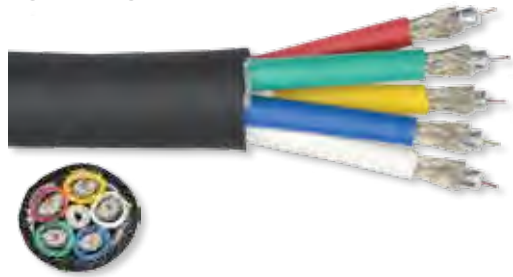

### Features & Benefits:

- 20 AWG solid annealed bare copper conductor
- Gas injected cellular polyethylene dielectric
- 100% coverage aluminum/poly/aluminum foil inner shield
- 95% coverage tinned copper braid shield
- Flame rated PVC jacket
- 5 coaxial cables jacketed together
- 3.0 GHz sweep, very low loss, excellent SRL
- NEC CMR, CEC CMR FT4, RoHS compliant
- 1000 foot spools

### RGB5C-20-CMR

#### Application:

- SMPTE serial digital video, STET AES3id digital audio
- S/PDIF digital audio, subwoofer audio
- All base band video and unbalanced analog audio
- RF modulated signals, CATV, DBS, MATV

NOM OD (INCHES): 0.740	AWG SIZE: 20	# OF PAIRS: N/A	# OF CONDUCTORS 5	AVAILABLE JACKET COLORS: ●
				PART NUMBER COLOR ID: BLK

## RGB 5 X 25 AWG SOLID MINI HIGH RESOLUTION COAXIAL VIDEO CABLE

**Commercial**  
NON-PLENUM



### Features & Benefits:

- 25 AWG solid annealed bare copper conductor
- Gas injected cellular polyethylene dielectric
- 100% coverage aluminum/poly shield
- 90% coverage tinned copper serve shield
- Flexible PVC jacket
- 5 coaxial cables jacketed together
- 1.0 GHz sweep, 250 MHz bandwidth
- NEC CM, CEC CM FT1, RoHS compliant
- 1000 foot spools

### RGB5C-25-CM

#### Application:

- Analog base band video signals, security video
- Unbalanced line level audio, subwoofer audio, S/PDIF
- Composite video, S-video, component video, RGB video



#### TOOLS & ACCESSORIES

Save time and money!  
See Page: 247

NOM OD (INCHES): 0.350	AWG SIZE: 25	# OF PAIRS: N/A	# OF CONDUCTORS 5	AVAILABLE JACKET COLORS: ●
				PART NUMBER COLOR ID: BLK

## RGB 5 X 26 AWG STRANDED MINI HIGH RESOLUTION COAXIAL VIDEO CABLE

**Commercial**  
NON-PLENUM



### Features & Benefits:

- 26 AWG 7 strand annealed tinned copper conductor
- Gas injected cellular polyethylene dielectric
- 95% coverage tinned copper serve shield
- 100% coverage aluminum/poly shield
- Flexible PVC jacket
- 5 coaxial cables jacketed together
- 1.0 GHz sweep, 200 MHz bandwidth
- NEC CM, CEC CMH FT1, RoHS compliant
- 1000 foot spools

### RGB5C-PVC

#### Application:

- Analog base band video signals, security video
- Unbalanced line level audio, subwoofer audio, S/PDIF
- Composite video, S-video, component video, RGB video

NOM OD (INCHES): 0.350	AWG SIZE: 26	# OF PAIRS: N/A	# OF CONDUCTORS 5	AVAILABLE JACKET COLORS: ●
				PART NUMBER COLOR ID: BLK

## RGB PROJECTOR NET 6 X 26 AWG STRANDED MINI HIGH RES COAXES & 2 X 22 AWG 1 PAIR AUDIO COMPOSITE CABLE

**Commercial**  
NON-PLENUM



### Features & Benefits:

- 26 AWG 7 strand annealed tinned copper conductor
- Gas injected cellular polyethylene dielectric
- 95% coverage tinned copper serve shield
- 100% coverage aluminum/poly shield
- Flexible PVC jacket
- 6 coaxial cables together with 2 audio pairs
- 1.0 GHz sweep, 200 MHz bandwidth
- NEC CM, CEC CMH FT1, RoHS compliant
- 1000 foot spools

### RGB6C/22-2P

#### Application:

- Analog base band video signals, security video
- Unbalanced line level audio, subwoofer audio, S/PDIF
- Composite video, S-video, component video, RGB video
- EDID and ID/DDC compliant VGA, projector single cable

NOM OD (INCHES): 0.410	AWG SIZE: 26/22	# OF PAIRS: 2	# OF CONDUCTORS 6/4	AVAILABLE JACKET COLORS: ●
				PART NUMBER COLOR ID: BLK

## RGB 5 X 25 AWG STRANDED MINI-RG59 COAXIAL VIDEO CABLE

**Residential**  
**NON-PLENUM**



**Features & Benefits:**

- 25 AWG 7 strand annealed bare copper conductor
- Gas injected cellular polyethylene dielectric
- 95% coverage tinned copper braid shield
- Flame rated PVC jacket
- 5 coaxial cables jacketed together
- 1.0 GHz sweep, 450 MHz bandwidth, excellent SRL
- NEC CMR, CEC CMR FT4, RoHS compliant
- 1000 foot spools

**RGB5-MINI**

**Application:**

- Analog base band video signals, security video
- Unbalanced line level audio, subwoofer audio, S/PDIF
- Composite video, S-video, component video, RGB video

NOM OD (INCHES): 0.500	AWG SIZE: 25	# OF PAIRS: N/A	# OF CONDUCTORS 5	AVAILABLE JACKET COLORS: ●	PART NUMBER COLOR ID: BLK
---------------------------	-----------------	--------------------	----------------------	----------------------------	---------------------------

## CCTV & BASEBAND VIDEO RG59 NON-PLENUM COAXIAL CABLE

**Security**  
**NON-PLENUM**



**Features & Benefits:**

- 20 AWG solid bare copper center conductor
- Gas injected cellular polyethylene dielectric
- Single shield, 95% 34 AWG bare copper braid
- Flame rated PVC jacket
- 1 GHz sweep test
- NEC CM, CEC CMG FT4, RoHS compliant
- 1000 foot spools

**RG59-CCTV-CM**

**Application:**

- Analog base band video signals, security video
- Unbalanced line level audio, subwoofer audio, S/PDIF
- Composite video, S-video, component video, RGB video



NOM OD (INCHES): 0.240	AWG SIZE: 20	# OF PAIRS: N/A	# OF CONDUCTORS 1	AVAILABLE JACKET COLORS: ●	PART NUMBER COLOR ID: BLK
---------------------------	-----------------	--------------------	----------------------	----------------------------	---------------------------

## CCTV & BASEBAND VIDEO RG59 OUTSIDE PLANT COAXIAL CABLE

**Security**  
**NON-PLENUM**



**Features & Benefits:**

- 20 AWG solid bare copper center conductor
- Gas injected cellular polyethylene dielectric
- Single shield, 95% 34 AWG bare copper braid
- Polyethylene jacket
- 1 GHz sweep test
- Direct burial, sunlight resistant, RoHS compliant
- 1000 foot spools

**RG59-DB-CCTV**

**Application:**

- Analog base band video signals, security video
- Unbalanced line level audio, subwoofer audio, S/PDIF
- Outside plant security and video

NOM OD (INCHES): 0.269	AWG SIZE: 20	# OF PAIRS: N/A	# OF CONDUCTORS 1	AVAILABLE JACKET COLORS: ●	PART NUMBER COLOR ID: BLK
---------------------------	-----------------	--------------------	----------------------	----------------------------	---------------------------

## CCTV & BASEBAND VIDEO RG6 NON-PLENUM COAXIAL CABLE

**Security**  
**NON-PLENUM**



**Features & Benefits:**

- 18 AWG solid bare copper center conductor
- Gas injected cellular polyethylene dielectric
- Single shield, 95% 34 AWG bare copper braid
- Flame rated PVC jacket
- 1 GHz sweep test
- NEC CM, CEC CMG FT4, RoHS compliant
- 1000 foot spools

**RG6-CCTV-CM**

**Application:**

- Analog base band video signals, security video
- Unbalanced line level audio, subwoofer audio, S/PDIF
- Composite video, S-video, component video, RGB video

NOM OD (INCHES): 0.264	AWG SIZE: 18	# OF PAIRS: N/A	# OF CONDUCTORS 1	AVAILABLE JACKET COLORS: ●	PART NUMBER COLOR ID: BLK
---------------------------	-----------------	--------------------	----------------------	----------------------------	---------------------------

## CCTV & BASEBAND WITH PAN/TILT/ZOOM VIDEO RG59 NON-PLENUM COAXIAL CABLE

**Security**  
NON-PLENUM



**Features & Benefits:**

- 20 AWG solid bare copper center conductor
- Gas injected cellular polyethylene dielectric
- Single shield: 95% 34 AWG bare copper braid
- Flame rated PVC jacket
- 18 AWG 2C stranded, twisted, unshielded and jacketed
- Both components cabled in paralleled (SPT)
- 1 GHz sweep test
- NEC CM, CEC CM, RoHS compliant
- 1000 foot spools

**RG59CM-18-2C**

**Application:**

- Analog base band video signals, security video
- Pan/Tilt/Zoom systems infrastructure cable



**PREMIUM CONNECTORS**  
Options for any type of professional installation  
See Page: 117

NOM OD (INCHES): .380 X .212	AWG SIZE: 20/18	# OF PAIRS: N/A	# OF CONDUCTORS 3	AVAILABLE JACKET COLORS: ●	PART NUMBER COLOR ID: BLK
---------------------------------	--------------------	--------------------	----------------------	----------------------------	---------------------------

## RGB CABLE WITH 3 MINI-RG59 HIGH DEFINITION COAXIAL CABLE

**Commercial**  
NON-PLENUM



**Features & Benefits:**

- 23 AWG solid annealed bare copper conductor
- Gas injected cellular polyethylene dielectric
- 100% coverage aluminum/poly/aluminum foil inner shield
- 95% coverage tinned copper braid shield
- Flame rated PVC jacket
- 3 coaxial cables jacketed together
- 3.0 GHz sweep, very low loss, excellent SRL
- NEC CMR, CEC CMR FT4, RoHS compliant
- 1000 foot spools

**RGB3C-23-CM**

**Application:**

- SMPTE serial digital video, AES3id digital audio
- S/PDIF digital audio, subwoofer audio
- All base band video and unbalanced analog audio
- RF modulated signals, CATV, DBS, MATV

NOM OD (INCHES): 0.415	AWG SIZE: 23	# OF PAIRS: N/A	# OF CONDUCTORS 3	AVAILABLE JACKET COLORS: ●	PART NUMBER COLOR ID: BLK
---------------------------	-----------------	--------------------	----------------------	----------------------------	---------------------------

## RGB CABLE WITH 3 SOLID CORE 25 AWG MINIATURE HIGH RESOLUTION COAXIAL CABLE

**Commercial**  
NON-PLENUM



**Features & Benefits:**

- 25 AWG solid annealed bare copper conductor
- Gas injected cellular polyethylene dielectric
- 100% coverage aluminum/poly shield
- 90% coverage tinned copper serve shield
- Flexible PVC jacket
- 3 coaxial cables jacketed together
- 1.0 GHz sweep, 250 MHz bandwidth
- NEC CM, CEC CM FT1, RoHS compliant
- 1000 foot spools

**RGB3C-25-CM**

**Application:**

- Analog base band video signals, security video
- Unbalanced line level audio, subwoofer audio, S/PDIF
- Composite video, S-video, component video

NOM OD (INCHES): 0.286	AWG SIZE: 25	# OF PAIRS: N/A	# OF CONDUCTORS 3	AVAILABLE JACKET COLORS: ●	PART NUMBER COLOR ID: BLK
---------------------------	-----------------	--------------------	----------------------	----------------------------	---------------------------

# HDMI ADAPTER RING

Keep your adapters where they need to be & immediately accessible for your mobile content presentation podium, boardroom, or docking station!

**DL-AR**

**PERFECT FOR:**

- Adapting various mobile content devices to HDMI
- Interfacing Laptops, Macs, iPad, Smartphone to HDMI

SEE PAGE 132



**DIGITALINX™**

## Analog Video: Plenum Cables

Plenum rated products have passed the highest flame test, NFPA-262. These products have a suffix of "P" after the article code. Some examples of the ratings you will find on the jacket are CL2P, CL3P, CMP, and OFNP. Plenum rated products can go between floors in commercial building where environmental air or air handling requirements exist for those spaces.

Other locations that will commonly call out Plenum requirements are the airspaces between drop ceilings and the actual construction. Plenum ratings are also authorized for in-wall use and plenum is backwards compatible for Riser, General Purpose, and Limited Use. Plenum rated product should never be used as OSP cable.

### NO SKEW UTP RGB VIDEO 23 AWG 4 PAIR U/UTP PLENUM CABLE

Commercial  
**PLENUM**



**Features & Benefits:**

- 23 AWG solid annealed bare copper conductors
- Fluoropolymer dielectric insulation
- Pairs in identical lay lengths and cabled together
- Plenum rated PVC jacket
- Inter-pair skew maximum 2.0 nS/100m
- NEC CMP, CEC CMP FT6, RoHS compliant
- 1000 foot spools

**TRUPHASE-P**

**Application:**

- Analog base band video signals, security video
- RGB, RGBs, RGBHV over twisted pair systems infrastructure
- Infrared, non-TIA/EIA data



**PREMIUM CONNECTORS**

Options for any type of professional installation  
See Page: 117

NOM OD (INCHES): 0.170	AWG SIZE: 23	# OF PAIRS: 4	# OF CONDUCTORS 8	AVAILABLE JACKET COLORS: ●
				PART NUMBER COLOR ID: BLK

### RGB 2 X 26 AWG STRANDED MINI-HIGH RESOLUTION YELLOW/RED PLENUM CABLE

Commercial  
**PLENUM**



**Features & Benefits:**

- 26 AWG 7 strand annealed tinned copper conductor
- Gas injected cellular fluoropolymer dielectric
- 95% coverage tinned copper serve shield
- 100% coverage aluminum/poly shield
- Plenum rated PVC jacket
- 2 coaxial cables in parallel and jacketed
- 1.0 GHz sweep, 200 MHz bandwidth
- NEC CMP, CEC CMP FT6, RoHS compliant
- 1000 foot spools

**SV-PLN**

**Application:**

- Analog base band video signals, security video
- Unbalanced line level audio, subwoofer audio, S/PDIF
- Composite video, S-video

NOM OD (INCHES): .230 X .147	AWG SIZE: 26	# OF PAIRS: N/A	# OF CONDUCTORS 2	AVAILABLE JACKET COLORS: ●
				PART NUMBER COLOR ID: BLK

### RGB 5 X 23 AWG MINI-RG59 SDI COAXIAL VIDEO PLENUM CABLE

Commercial  
**PLENUM**



**Features & Benefits:**

- 23 AWG solid annealed bare copper conductor
- Gas injected cellular fluoropolymer dielectric
- 100% coverage aluminum/poly/aluminum foil inner shield
- 95% coverage tinned copper braid shield
- Plenum rated PVDF jacket
- 5 coaxial cables jacketed together
- 3.0 GHz sweep, very low loss, excellent SRL
- NEC CMP, CEC CMP FT6, RoHS compliant
- 1000 foot spools

**RGB5C-23-CMP**

**Application:**

- SMPTE serial digital video, AES3id digital audio
- S/PDIF digital audio, subwoofer audio
- All base band video and unbalanced analog audio
- RF modulated signals, CATV, DBS, MATV

NOM OD (INCHES): 0.460	AWG SIZE: 23	# OF PAIRS: N/A	# OF CONDUCTORS 5	AVAILABLE JACKET COLORS: ●
				PART NUMBER COLOR ID: BLK



## RGB 5 X 25 AWG SOLID MINI HIGH RESOLUTION COAXIAL VIDEO PLENUM CABLE

Commercial  
PLENUM

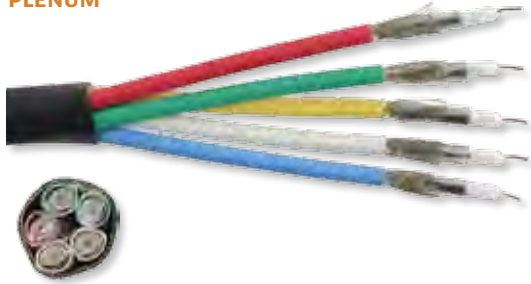

### Features & Benefits:

- 25 AWG solid annealed bare copper conductor
- Gas injected cellular fluoropolymer dielectric
- 100% coverage aluminum/poly shield
- 90% coverage tinned copper serve shield
- Plenum rated PVC jacket
- 5 coaxial cables jacketed together
- 1.0 GHz sweep, 250 MHz bandwidth
- NEC CMP, CEC CMP FT6, RoHS compliant
- 1000 foot spools

### RGB5C-25-CMP

#### Application:

- Analog base band video signals, security video
- Unbalanced line level audio, subwoofer audio, S/PDIF
- Composite video, S-video, component video, RGB video



#### TECH SPECS

Up-to-date and complete tech specs for all products available at [www.LibAV.com](http://www.LibAV.com)

NOM OD (INCHES): 0.315	AWG SIZE: 25	# OF PAIRS: N/A	# OF CONDUCTORS 5	AVAILABLE JACKET COLORS: ●
				PART NUMBER COLOR ID: BLK

## RGB 5 X 26 AWG STRANDED MINI HIGH RESOLUTION COAXIAL VIDEO PLENUM CABLE

Commercial  
PLENUM



### Features & Benefits:

- 26 AWG 7 strand annealed tinned copper conductor
- Gas injected cellular fluoropolymer dielectric
- 95% coverage tinned copper serve shield
- 100% coverage aluminum/poly shield
- Plenum rated PVC jacket
- 5 coaxial cables jacketed together
- 1.0 GHz sweep, 200 MHz bandwidth
- NEC CMP, CEC CMP FT6, RoHS compliant
- 1000 foot spools

### RGB5C-PLN

#### Application:

- Analog base band video signals, security video
- Unbalanced line level audio, subwoofer audio, S/PDIF
- Composite video, S-video, component video, RGB video

NOM OD (INCHES): 0.320	AWG SIZE: 26	# OF PAIRS: N/A	# OF CONDUCTORS 5	AVAILABLE JACKET COLORS: ●
				PART NUMBER COLOR ID: BLK

## RGB PROJECTOR NET 6 X 25 AWG SOLID MINI HIGH RES COAXES & 2 X 22 AWG 1 PAIR AUDIO COMPOSITE PLENUM CABLE

Commercial  
PLENUM



### Features & Benefits:

- 25 AWG solid annealed bare copper conductor
- Gas injected cellular fluoropolymer dielectric
- 100% coverage aluminum/poly shield
- 90% coverage tinned copper serve shield
- Plenum rated PVC jacket
- 6 coaxial cables jacketed together with 2 audio pairs
- 1.0 GHz sweep, 250 MHz bandwidth
- NEC CMP, CEC CMP FT6, RoHS compliant
- 1000 foot spools

### RGB6C-25/22-2P-CMP

#### Application:

- Analog base band video signals, security video
- Unbalanced line level audio, subwoofer audio, S/PDIF
- Composite video, S-video, component video, RGB video
- EDID and ID/DDC compliant VGA, projector single cable

NOM OD (INCHES): 0.370	AWG SIZE: 26/22	# OF PAIRS: 2	# OF CONDUCTORS 6/4	AVAILABLE JACKET COLORS: ●
				PART NUMBER COLOR ID: BLK

# WebBlox®

# CUSTOM PLATE DESIGN

ADD YOUR OWN LOGO | FREE SERVICE | DESIGN ONLINE, 24/7



This free design and quoting tool gives you complete control over designing your own custom plate and panel layouts. All PanelCrafters® standard panel sizes are available.

**PANEL CRAFTERS**  
CUSTOM PLATES & PANELS

**GO FROM CONCEPT TO COMPLETE PLATE DESIGN IN MINUTES!**

Check it out at [www.LibAV.com](http://www.LibAV.com)

## RGB PROJECTOR NET 6 X 26 AWG STRANDED MINI HIGH RES COAXES & 2 X 22 AWG 1 PAIR AUDIO COMPOSITE PLENUM CABLE

**Commercial**  
**PLENUM**



**Features & Benefits:**

- 26 AWG 7 strand annealed tinned copper conductor
- Gas injected cellular fluoropolymer dielectric
- 95% coverage tinned copper serve shield
- 100% coverage aluminum/poly shield
- Plenum rated PVC jacket
- 6 coaxial cables cabled together with 2 audio pairs
- 1.0 GHz sweep, 200 MHz bandwidth
- NEC CMP, CEC CMP FT6, RoHS compliant
- 1000 foot spools

**RGB6C/22-2P-PLN**

**Application:**

- Analog base band video signals, security video
- Unbalanced line level audio, subwoofer audio, S/PDIF
- Composite video, S-video, component video, RGB video
- EDID and ID/DDC compliant VGA, projector single cable

NOM OD (INCHES): 0.370	AWG SIZE: 26/22	# OF PAIRS: 2	# OF CONDUCTORS 6/4	AVAILABLE JACKET COLORS: ●	PART NUMBER COLOR ID: BLK
---------------------------	--------------------	------------------	------------------------	----------------------------	---------------------------

## CCTV & BASEBAND VIDEO RG59 PLENUM COAXIAL CABLE

**Security**  
**PLENUM**



**Features & Benefits:**

- 20 AWG solid annealed bare copper conductor
- Gas injected cellular fluoropolymer dielectric
- Single shield, 95% 34 AWG bare copper braid
- Plenum rated PVC jacket
- 1 GHz sweep test
- NEC CMP, CEC CMP FT6, RoHS compliant
- 1000 foot spools standard

**RG59-CCTV-PL**

**Application:**

- Analog base band video signals, security video
- Unbalanced line level audio, subwoofer audio, S/PDIF
- Composite video, S-video, component video, RGB video



**TOOLS & ACCESSORIES**  
Save time and money!  
See Page: 247

NOM OD (INCHES): 0.193	AWG SIZE: 20	# OF PAIRS: N/A	# OF CONDUCTORS 1	AVAILABLE JACKET COLORS: ○	PART NUMBER COLOR ID: WHT
---------------------------	-----------------	--------------------	----------------------	----------------------------	---------------------------

## CCTV & BASEBAND VIDEO RG6 PLENUM COAXIAL CABLE

**Security**  
**PLENUM**



**Features & Benefits:**

- 18 AWG solid annealed bare copper conductor
- Gas injected cellular fluoropolymer dielectric
- Single shield, 95% 34 AWG bare copper braid
- Plenum rated PVC jacket
- 1 GHz sweep test
- NEC CMP, CEC CMP FT6, RoHS compliant
- 1000 foot spools standard

**RG6-CCTV-PL**

**Application:**

- Analog base band video signals, security video
- Unbalanced line level audio, subwoofer audio, S/PDIF
- Composite video, S-video, component video, RGB video

NOM OD (INCHES): 0.229	AWG SIZE: 18	# OF PAIRS: N/A	# OF CONDUCTORS 1	AVAILABLE JACKET COLORS: ● ○	PART NUMBER COLOR ID: BLK WHT
---------------------------	-----------------	--------------------	----------------------	------------------------------	-------------------------------

## CCTV & BASEBAND WITH PAN/TILT/ZOOM VIDEO RG59 PLENUM COAXIAL CABLE

**Security**  
**PLENUM**



**Features & Benefits:**

- 20 AWG solid annealed bare copper conductor
- Gas injected cellular fluoropolymer dielectric
- Single shield, 95% 34 AWG bare copper braid
- Plenum rated PVC jacket
- 18 AWG 2C stranded, twisted, unshielded and jacketed
- 1 GHz sweep test
- NEC CMP, CEC CMP FT6, RoHS compliant
- 1000 foot spools standard

**RG59-18/2C-PS**

**Application:**

- Analog base band video signals, security video
- Plenum Pan/Tilt/Zoom systems infrastructure cable



**PREMIUM CONNECTORS**  
Options for any type of professional installation  
See Page: 117

NOM OD (INCHES): .380 X .200	AWG SIZE: 20/18	# OF PAIRS: N/A	# OF CONDUCTORS 3	AVAILABLE JACKET COLORS: ○	PART NUMBER COLOR ID: WHT
---------------------------------	--------------------	--------------------	----------------------	----------------------------	---------------------------

## “CATEGORY/LAN/DATA

Liberty offers Category Cable in Category 5e, 6, 6 Augmented in plenum and riser ratings with a choice of shielded and unshielded formats. Liberty's EN series is a step above the rest with positive ACR values to 350 MHz for Category 5e and 500 MHz for Category 6. Need a good performing cable cheaper? Our HomeTrax™ was recently upgraded to CMR fire ratings and positive ACR to 200 MHz for Category 5e and 300 MHz for Category 6. That's better than most others 350 and 550 MHz offerings on the market. The higher frequency threshold the ACR stays above zero – the better the cable.





## CATEGORY 5E U/UTP EN SERIES 24 AWG 4 PAIR UNSHIELDED PATCH CABLE

**Category 5e**  
**NON-PLENUM**

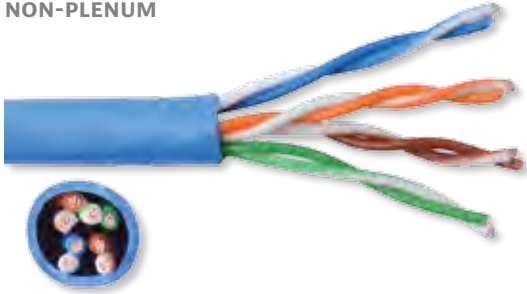

**Features & Benefits:**

- Stranded annealed bare copper conductors
- High density polyethylene insulation
- 4 pairs twisted in varying lays and cabled
- Flame rated PVC jacket
- ANSI/TIA-568C Category 5e Patch Cable
- NEC CM, CEC CMH FT1, RoHS compliant
- 1000 foot spools

**24-4P-STR-L5-EN**

**Application:**

- Horizontal LAN 10/100/1000BaseT ethernet
- High flex environments such as elevators and lifts
- Field manufacture of patch cables and interconnects
- Touch screen cabling infrastructure
- PoE, HDBaseT, analog and digital media

NOM OD (INCHES): 0.197	AWG SIZE: 24	# OF PAIRS: 4	# OF CONDUCTORS 8	AVAILABLE JACKET COLORS: ●
				PART NUMBER COLOR ID: BLU

## CATEGORY 5E U/UTP EN SERIES DUAL 24 AWG 4 PAIR UNSHIELDED CABLE IN 2 OUTER JACKETS

**Commercial**  
**NON-PLENUM**

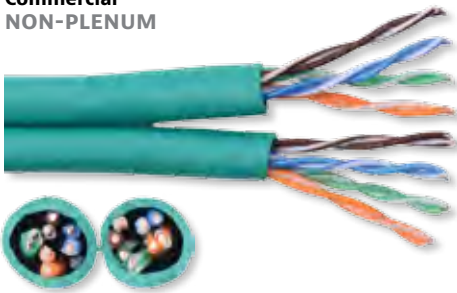

**Features & Benefits:**

- Solid annealed bare copper conductors
- High density polyethylene insulation
- 4 pairs twisted in varying lays and cabled
- Flame rated PVC jacket
- 2 jacketed cables in parallel (SPT) and joined with a web
- ANSI/TIA-568C Category 5e tested to 350 MHz
- NEC CMR, CEC CMR FT4, RoHS compliant
- 1000 foot spools, Cool Spool System® boxes

**24-8P-L5E-SIAM**

**Application:**

- Horizontal LAN 10/100/1000BaseT ethernet
- Audio, video, infrared, IP control
- Balun infrastructure, voice, voice over IP
- PoE, HDBaseT, analog and digital media



NOM OD (INCHES): 0.430	AWG SIZE: 24	# OF PAIRS: 8	# OF CONDUCTORS 16	AVAILABLE JACKET COLORS: ● ●
				PART NUMBER COLOR ID: BLU GRN

## HOMETRAX™ ECONOMY 24 AWG 4 PAIR U/UTP CATEGORY 5E CABLE

**Category 5e**  
**NON-PLENUM**

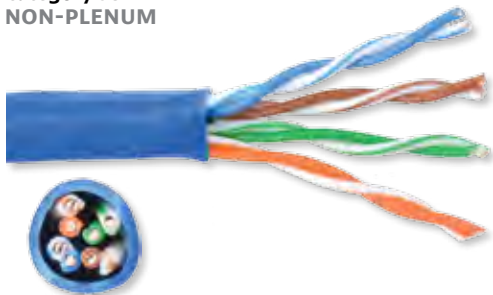

**Features & Benefits:**

- HomeTrax™ economy grade U/UTP cabling
- Solid annealed bare copper conductors
- High density polyethylene insulation
- 4 pairs twisted in varying lays and cabled
- Flame rated PVC jacket
- ANSI/TIA-568C Category 5e
- NEC CMR, CEC CMR FT4, RoHS compliant
- 1000 foot nested boxes

**24-4P-L5-HT**

**Application:**

- Horizontal LAN 10/100/1000BaseT ethernet
- Audio, video, infrared, IP control
- Balun infrastructure, voice, voice over IP
- PoE, HDBaseT, analog and digital media

NOM OD (INCHES): 0.197	AWG SIZE: 24	# OF PAIRS: 4	# OF CONDUCTORS 8	AVAILABLE JACKET COLORS: ● ● ● ●
				PART NUMBER COLOR ID: BLU GRY WHT GRN

## CATEGORY 6 F/UTP EN SERIES 23 AWG 4 PAIR SHIELDED CABLE

**Category 6**  
**NON-PLENUM**



**Features & Benefits:**

- Solid annealed bare copper conductors
- High density polyethylene insulation
- 4 pairs twisted in varying lays and cabled
- Overall aluminum/poly foil shield with drain
- Flame rated PVC jacket
- ANSI/TIA-568C Category 6
- NEC CMR, CEC CMR FT4, RoHS compliant
- 1000 foot spools

**24-4P-L6SH**

**Application:**

- Horizontal LAN 10/100/1000BaseT ethernet
- Audio, video, infrared, IP control
- Balun infrastructure, voice, voice over IP
- PoE, HDBaseT, analog and digital media

NOM OD (INCHES): 0.269	AWG SIZE: 23	# OF PAIRS: 4	# OF CONDUCTORS 8	AVAILABLE JACKET COLORS: ● ●
				PART NUMBER COLOR ID: BLK PUR

## CATEGORY 6 U/UTP EN SERIES 23 AWG 4 PAIR UNSHIELDED CABLE

**Category 6**  
NON-PLENUM

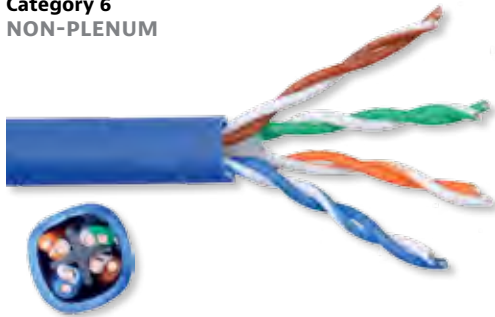

**Features & Benefits:**

- Solid annealed bare copper conductors
- High density polyethylene insulation
- 4 pairs twisted in varying lays and cabled
- Flame rated PVC jacket
- ANSI/TIA-568C Category 6 and tested to 550 MHz
- NEC CMR, CEC CMR FT4, RoHS compliant
- 1000 foot spools or Cool Spool System® boxes

**24-4P-L6-EN**

**Application:**

- Horizontal LAN 10/100/1000BaseT ethernet
- Audio, video, infrared, IP control
- Balun infrastructure, voice, voice over IP
- PoE, HDBaseT, analog and digital media



NOM OD (INCHES): 0.244	AWG SIZE: 23	# OF PAIRS: 4	# OF CONDUCTORS 8	AVAILABLE JACKET COLORS: ● ● ● ● ● ● ● ●
PART NUMBER COLOR ID:				BLK BLU GRY ORG PUR WHT GRN YEL

## CATEGORY 6 U/UTP EN SERIES 23 AWG 4 PAIR UNSHIELDED CABLE

**Category 6**  
NON-PLENUM



**Features & Benefits:**

- Solid annealed bare copper conductors
- High density polyethylene insulation
- 4 pairs twisted in varying lays and cabled with floodant
- UV stabilized polyethylene jacket
- ANSI/TIA-568C Category 6
- Direct burial, sunlight resistant, RoHS compliant
- 1000 foot spools

**24-4P-L6-EN-DB**

**Application:**

- Outdoor LAN 10/100/1000BaseT ethernet
- Audio, video, infrared, IP control
- Balun infrastructure, voice, voice over IP
- PoE, HDBaseT, analog and digital media



NOM OD (INCHES): 0.250	AWG SIZE: 23	# OF PAIRS: 4	# OF CONDUCTORS 8	AVAILABLE JACKET COLORS: ●
PART NUMBER COLOR ID:				BLK

## CATEGORY 6 U/UTP EN SERIES DUAL 23 AWG 4 PAIR UNSHIELDED CABLE IN 2 OUTER JACKETS

**Category 6**  
NON-PLENUM

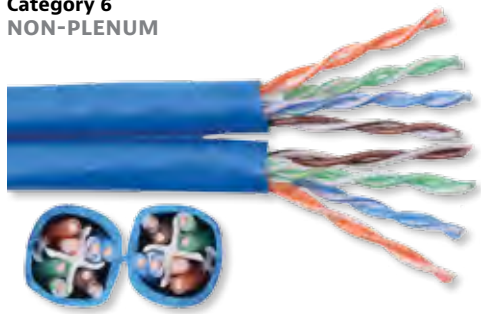

**Features & Benefits:**

- Solid annealed bare copper conductors
- High density polyethylene insulation
- 4 pairs twisted in varying lays and cabled
- Flame rated PVC jacket
- 2 jacketed cables in parallel (SPT) and joined with a web
- ANSI/TIA-568C Category 6
- NEC CMR, CEC CMR FT4, RoHS compliant
- 1000 foot spools or Cool Spool System® boxes

**24-8P-L6-SIAM**

**Application:**

- Horizontal LAN 10/100/1000BaseT ethernet
- Audio, video, infrared, IP control
- Balun infrastructure, voice, voice over IP
- PoE, HDBaseT, analog and digital media

NOM OD (INCHES): .234X.478	AWG SIZE: 23	# OF PAIRS: 8	# OF CONDUCTORS 16	AVAILABLE JACKET COLORS: ●
PART NUMBER COLOR ID:				BLU

## HOMETRAX™ ECONOMY 24 AWG 4 PAIR U/UTP CATEGORY 6 CABLE

**Category 6**  
NON-PLENUM



**HomeTrax**  
ECONOMY CABLE

**Features & Benefits:**

- HomeTrax™ economy grade U/UTP cabling
- Solid annealed bare copper conductors
- High density polyethylene insulation
- 4 pairs twisted in varying lays and cabled
- Flame rated PVC jacket
- ANSI/TIA-568C Category 6
- NEC CMR, CEC CMR FT4, RoHS compliant
- 1000 foot nested boxes

**24-4P-L6-HT**

**Application:**

- Horizontal LAN 10/100/1000BaseT ethernet
- Audio, video, infrared, IP control
- Balun infrastructure, voice, voice over IP
- PoE, HDBaseT, analog and digital media



NOM OD (INCHES): 0.224	AWG SIZE: 23	# OF PAIRS: 4	# OF CONDUCTORS 8	AVAILABLE JACKET COLORS: ● ● ● ●
PART NUMBER COLOR ID:				BLU GRY WHT GRN

## CATEGORY 6A F/UTP EN SERIES 23 AWG 4 PAIR SHIELDED CABLE

**Category 6A**  
**NON-PLENUM**

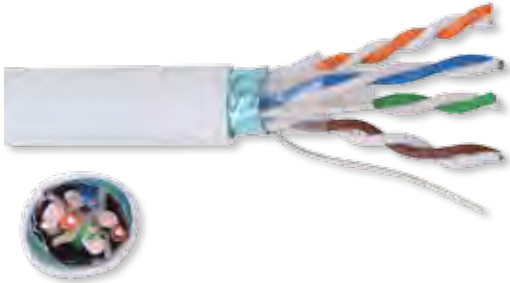

**Features & Benefits:**

- Solid annealed bare copper conductors
- High density polyethylene insulation
- 4 pairs twisted in varying lays and cabled
- Overall aluminum/poly foil shield with drain
- Flame rated PVC jacket
- ANSI/TIA-568C Category 6A
- NEC CMR, CEC CMR FT4, RoHS compliant
- 1000 foot spools

**24-4P-L6ASH**

**Application:**

- Horizontal LAN 10/100/1000/10GBaseT ethernet
- Audio, video, infrared, IP control
- Balun infrastructure, voice, voice over IP
- PoE, HDBaseT, analog and digital media

NOM OD (INCHES): 0.290	AWG SIZE: 23	# OF PAIRS: 4	# OF CONDUCTORS 8	AVAILABLE JACKET COLORS: <input type="radio"/>	PART NUMBER COLOR ID: WHT
---------------------------	-----------------	------------------	----------------------	--	---------------------------

## RS-232 UNIVERSAL 24 AWG 4 PAIR SHIELDED LOW CAPACITANCE CABLE

**Commercial**  
**NON-PLENUM**

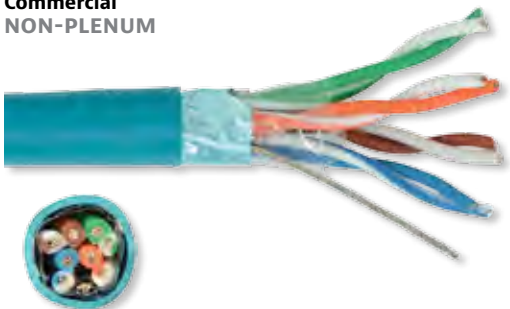

**Features & Benefits:**

- Stranded annealed tinned copper conductors
- Cellular polyethylene insulation
- 4 pairs twisted in varying lays and cabled
- Overall aluminum/poly foil shield with drain
- Flame rated PVC jacket
- Low capacitance 100 ohm digital construction
- NEC CM, CEC CMG FT4, RoHS compliant
- 1000 foot spools

**24-4P-SH**

**Application:**

- RS-232, RS-422, RS-485 non-TIA data formats
- High flex environments such as elevators and lifts
- Field manufacture of RS-232 cables
- Touch screen cabling infrastructure

NOM OD (INCHES): 0.210	AWG SIZE: 24	# OF PAIRS: 4	# OF CONDUCTORS 8	AVAILABLE JACKET COLORS: <input checked="" type="radio"/>	PART NUMBER COLOR ID: TEA
---------------------------	-----------------	------------------	----------------------	---	---------------------------

## Category/LAN/Data: Plenum Cables

Plenum rated products have passed the highest flame test, NFPA-262. These products have a suffix of "P" after the article code. Some examples of the ratings you will find on the jacket are CL2P, CL3P, CMP, and OFNP. Plenum rated products can go between floors in commercial building where environmental air or air handling requirements exist for those spaces.

Other locations that will commonly call out Plenum requirements are the airspaces between drop ceilings and the actual construction. Plenum ratings are also authorized for in-wall use and plenum is backwards compatible for Riser, General Purpose, and Limited Use. Plenum rated product should never be used as OSP cable.

## CATEGORY 5E F/UTP EN SERIES PLENUM 24 AWG 4 PAIR SHIELDED CABLE

**Category 5e**  
**PLENUM**

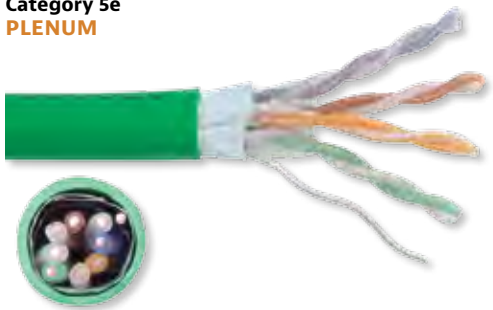

**Features & Benefits:**

- Solid annealed bare copper conductors
- Fluoropolymer insulation
- 4 pairs twisted in varying lays and cabled
- Overall aluminum/poly foil shield with drain
- Plenum rated PVC jacket
- ANSI/TIA-568C Category 5e tested to 350 MHz
- NEC CMP, CEC CMP FT6, RoHS compliant
- 1000 foot spools

**24-4P-P-L5SH**

**Application:**

- Horizontal LAN 10/100/1000BaseT ethernet
- Audio, video, infrared, IP control
- Balun infrastructure, voice, voice over IP
- PoE, HDBaseT, analog and digital media

NOM OD (INCHES): 0.225	AWG SIZE: 24	# OF PAIRS: 4	# OF CONDUCTORS 8	AVAILABLE JACKET COLORS: <input checked="" type="radio"/> <input type="radio"/> <input type="radio"/> <input type="radio"/>	PART NUMBER COLOR ID: BLK WHT YEL GRN
---------------------------	-----------------	------------------	----------------------	---	---------------------------------------

## CATEGORY 5E U/UTP EN SERIES 24 AWG 4 PAIR UNSHIELDED CABLE

**Category 5e**  
**PLENUM**

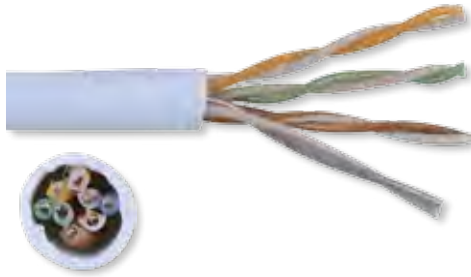

**Features & Benefits:**

- Solid annealed bare copper conductors
- Fluoropolymer insulation
- 4 pairs twisted in varying lays and cabled
- Plenum rated PVC jacket
- ANSI/TIA-568C Category 5e tested to 350 MHz
- NEC CMP, CEC CMP FT6, RoHS compliant
- 1000 foot spools, nested boxes, or Cool Spool System® boxes

**24-4P-P-L5-EN**

**Application:**

- Horizontal LAN 10/100/1000BaseT ethernet
- Audio, video, infrared, IP control
- Balun infrastructure, voice, voice over IP
- PoE, HDBaseT, analog and digital media



NOM OD (INCHES): 0.195	AWG SIZE: 24	# OF PAIRS: 4	# OF CONDUCTORS 8	AVAILABLE JACKET COLORS: PART NUMBER COLOR ID:	<input type="checkbox"/> BLK <input type="checkbox"/> BLU <input type="checkbox"/> GRY <input type="checkbox"/> ORG <input type="checkbox"/> WHT <input type="checkbox"/> PUR <input type="checkbox"/> GRN <input type="checkbox"/> YEL
---------------------------	-----------------	------------------	----------------------	---	---

## CATEGORY 6 F/UTP EN SERIES 23 AWG 4 PAIR SHIELDED CABLE

**Category 6**  
**PLENUM**

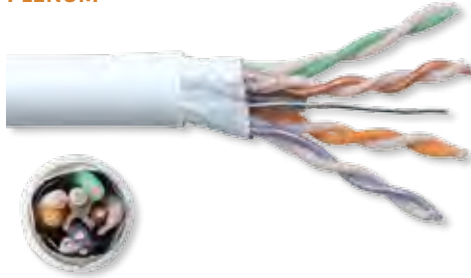

**Features & Benefits:**

- Solid annealed bare copper conductors
- Fluoropolymer insulation
- 4 pairs twisted in varying lays and cabled
- Overall aluminum/poly foil shield with drain
- Plenum rated PVC jacket
- ANSI/TIA-568C Category 6
- NEC CMP, CEC CMP FT6, RoHS compliant
- 1000 foot spools

**24-4P-P-L6SH**

**Application:**

- Horizontal LAN 10/100/1000BaseT ethernet
- Audio, video, infrared, IP control
- Balun infrastructure, voice, voice over IP
- PoE, HDBaseT, analog and digital media

NOM OD (INCHES): 0.251	AWG SIZE: 23	# OF PAIRS: 4	# OF CONDUCTORS 8	AVAILABLE JACKET COLORS: PART NUMBER COLOR ID:	<input type="checkbox"/> WHT
---------------------------	-----------------	------------------	----------------------	---	------------------------------

## CATEGORY 6 U/UTP EN SERIES 23 AWG 4 PAIR UNSHIELDED CABLE

**Category 6**  
**PLENUM**

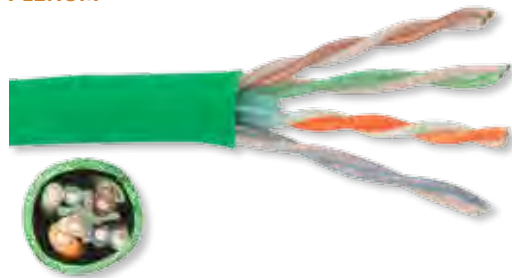

**Features & Benefits:**

- Solid annealed bare copper conductors
- Fluoropolymer insulation
- 4 pairs twisted in varying lays and cabled
- Plenum rated PVC jacket
- ANSI/TIA-568C Category 6 tested to 550 MHz
- NEC CMP, CEC CMP FT6, RoHS compliant
- 1000 foot spools or Cool Spool System® boxes

**24-4P-P-L6-EN**

**Application:**

- Horizontal LAN 10/100/1000BaseT ethernet
- Audio, video, infrared, IP control
- Balun infrastructure, voice, voice over IP
- PoE, HDBaseT, analog and digital media



NOM OD (INCHES): 0.220	AWG SIZE: 23	# OF PAIRS: 4	# OF CONDUCTORS 8	AVAILABLE JACKET COLORS: PART NUMBER COLOR ID:	<input type="checkbox"/> BLK <input type="checkbox"/> BLU <input type="checkbox"/> GRY <input type="checkbox"/> WHT <input type="checkbox"/> GRN <input type="checkbox"/> YEL
---------------------------	-----------------	------------------	----------------------	---	---

## RS-232 UNIVERSAL 24 AWG 4 PAIR SHIELDED LOW CAPACITANCE PLENUM CABLE

**Commercial**  
**PLENUM**

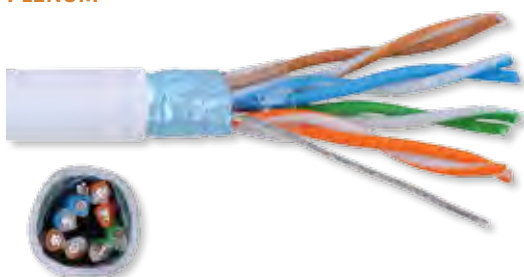

**Features & Benefits:**

- Stranded annealed tinned copper conductors
- Cellular fluoropolymer insulation
- 4 pairs twisted in varying lays and cabled
- Overall aluminum/poly foil shield with drain
- Plenum rated PVC jacket
- Low capacitance 100 ohm digital construction
- NEC CMP, CEC CMP FT6, RoHS compliant
- 1000 foot spools

**24-4P-PLCSH**

**Application:**

- RS-232, RS-422, RS-485 non-TIA data formats
- High flex environments such as elevators and lifts
- Field manufacture of RS-232 cables
- Touch screen cabling infrastructure

NOM OD (INCHES): 0.210	AWG SIZE: 24	# OF PAIRS: 4	# OF CONDUCTORS 8	AVAILABLE JACKET COLORS: PART NUMBER COLOR ID:	<input type="checkbox"/> WHT
---------------------------	-----------------	------------------	----------------------	---	------------------------------



# DIGITAL AUDIO

“ Precise 110 Ohm impedance, ultra-low capacitance and foamed PE or FEP insulation makes all of our Digital Audio twisted pair cable excellent performers. Designed and manufactured for AES/EBU balanced audio formats, this cable is also great for Simplex RS-485 (DMX 512) protocol and it is backwards compatible to all analog audio balanced formats. Use SDI coaxial cable for AES3id or S/PDIF unbalanced formats. ”

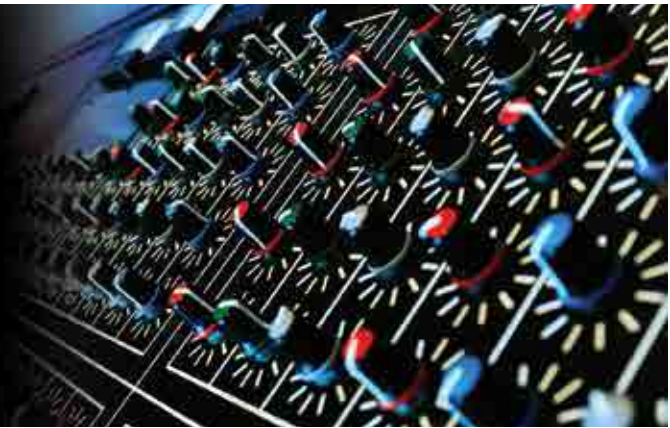

## AES/EBU 110 OHM DIGITAL AUDIO 24 AWG 1 PAIR

**Broadcast Quality**  
NON-PLENUM



**Features & Benefits:**

- 7 strand annealed tinned copper conductors
- Cellular polyethylene dielectric insulation
- Tightly twisted and shielded
- Semi pressure extruded PVC jacket
- 110 Ohm impedance, 11.5 pF/FT ultra low capacitance
- NEC CM, CEC CMG FT4, RoHS compliant
- 1000 foot spools

**24-1P-DIG**

**Application:**

- AES/EBU digital audio, line level, microphone audio
- Balanced and unbalanced audio formats, DMX-512 Simplex
- Infrared (IR), RS-232C signaling
- Instrumentation and control

NOM OD (INCHES): 0.180	AWG SIZE: 24	# OF PAIRS: 1	# OF CONDUCTORS: 2	AVAILABLE JACKET COLORS: ●
				PART NUMBER COLOR ID: BLK

## AES/EBU 110 OHM DIGITAL AUDIO

**Broadcast Quality**  
PLENUM



**Features & Benefits:**

- 7 strand annealed tinned copper conductors
- Cellular fluoropolymer dielectric insulation
- Tightly twisted and shielded
- Semi pressure extruded plenum PVC jacket
- 110 Ohm impedance, 11.5 pF/FT ultra low capacitance
- NEC CMP, CEC CMP FT6, RoHS compliant
- 1000 foot spools

**24-1P-P-DIG-AUDIO**

**Application:**

- AES/EBU digital audio, line level, microphone audio
- Balanced and unbalanced audio formats, DMX-512 Simplex
- Infrared (IR), RS-232C signaling
- Instrumentation and control

NOM OD (INCHES): 0.165	AWG SIZE: 24	# OF PAIRS: 1	# OF CONDUCTORS: 2	AVAILABLE JACKET COLORS: ○
				PART NUMBER COLOR ID: WHT

# HDMI ADAPTER RING

Keep your adapters where they need to be & immediately accessible for your mobile content presentation podium, boardroom, or docking station!

**DL-AR**

**PERFECT FOR:**

- Adapting various mobile content devices to HDMI
- Interfacing Laptops, Macs, iPad, Smartphone to HDMI

SEE PAGE 132



**DIGITALINX™**

# BETTER, STRONGER, EXPANSIVE!

Liberty's brand new expansive website has all of the complete information and tools you need to easily research and get what you need for your next profitable installation job.

[www.LibAV.com](http://www.LibAV.com)



## RUN WITH US

[www.LibAV.com](http://www.LibAV.com) | 800.530.8998

- Keep all of your custom information and part numbers in a **password-protected area**
- Utilize our **Learning Center** for training videos, white papers and online product info
- Find complete, **up-to-date specs**, information and cross reference
- Check out our **super high-res product photography** & download any image you need
- Download any of our **literature** including our catalog, sell sheets & application brochures
- Find great deals on closeout items in our **Bargain Bin**, where prices drop daily
- Easily find our newest products right on the front page in our **Product Showcase**



“ DIGITAL VIDEO

Liberty provides SMPTE Serial Digital Video cables from Mini-RG59 to RG6 sized formats. All of our products are swept to 4.5 GHz and feature exceptional SRL ratios. These cables support up to 3G-SDI formats and all analog and digital audio formats that use coaxial cable.



## Digital Video Bulk: Non-Plenum Cables

Liberty's definition of non-plenum cable is basically no plenum. We have the following levels grouped under non-plenum so please pay attention to the ratings you need and require:

**RISER:** Signified by the suffix "R" after the article code. These include CL2R, CL3R, CMR, OFNR. The Riser rating indicates the cable has passed the UL1666 Flame test. Riser rated cables are backwards compatible to general purpose and limited use cables and Riser ratings are permissible for substitution per the National Electric Code®. Riser rated products can go between floors in commercial building risers as long as there is no environmental air or air handling in those spaces. Riser ratings are authorized for in-wall use.

**GENERAL PURPOSE:** There are two levels of general purpose ratings. Ratings with a suffix of "G" after the article code are certified to the Canadian FT4 flame test. An example is a rating of CMG. If there is no rating suffix at all, such as CL2, CL3, CM, or

OFN then the cable has passed the US UL1685 vertical flame test. General purpose cables are backwards compatible to limited use cables. General purpose ratings are good for single floor use. They cannot be routed between floors except in 1 and 2 family residences.

**LIMITED USE:** Liberty generally does not stock or sell limited use cables. These are signified by a suffix of "X" after the article code. CL2X, CL3X, CMX for example. These are limited to 1 and 2 story, 1 and 2 family residences. They can be used in commercial spaces but only in approved conduit.

**OUTSIDE PLANT:** Also called OSP for short. This is product that has been certified for use in sunlight exposed and direct burial applications outdoors. Liberty OSP products meet all UL requirements for Sunlight Resistance and Direct Burial applications. The products have been tested for UL's crush resistance. At Liberty, we ensure compliance to all code requirements.

### SERIAL DIGITAL RG6 DUAL SHIELD 4.5 GHZ COAXIAL CABLE

Commercial  
NON-PLENUM



#### Features & Benefits:

- 18 AWG solid annealed bare copper conductor
- Gas injected cellular polyethylene dielectric
- 100% coverage aluminum/poly/aluminum foil inner shield
- 95% coverage tinned copper braid shield
- Flame rated PVC jacket
- 4.5 GHz sweep, very low loss, excellent SRL
- NEC CMR, CEC CMR FT4, RoHS compliant
- 1000 foot spools

#### 18-CMR-SD

##### Application:

- SMPTE serial digital video, AES3id digital audio
- S/PDIF digital audio, subwoofer audio
- All base band video and unbalanced analog audio
- RF modulated signals, CATV, DBS, MATV



NOM OD (INCHES): 0.272	AWG SIZE: 18	# OF PAIRS: N/A	# OF CONDUCTORS 1	AVAILABLE JACKET COLORS: PART NUMBER COLOR ID:	● BLK ● BLU ● YEL ● GREEN ● RED ● WHT
---------------------------	-----------------	--------------------	----------------------	---	---------------------------------------

### SERIAL DIGITAL RG59 DUAL SHIELD 4.5 GHZ COAXIAL CABLE

Commercial  
NON-PLENUM



#### Features & Benefits:

- 20 AWG solid annealed bare copper conductor
- Gas injected cellular polyethylene dielectric
- 100% coverage aluminum/poly/aluminum foil inner shield
- 95% coverage tinned copper braid shield
- Flame rated PVC jacket
- 4.5 GHz sweep, very low loss, excellent SRL
- NEC CMR, CEC CMR FT4, RoHS compliant
- 1000 foot spools

#### 20-CMR-VIDEO

##### Application:

- SMPTE serial digital video, AES3id digital audio
- S/PDIF digital audio, subwoofer audio
- All base band video and unbalanced analog audio
- RF modulated signals, CATV, DBS, MATV

NOM OD (INCHES): 0.242	AWG SIZE: 20	# OF PAIRS: N/A	# OF CONDUCTORS 1	AVAILABLE JACKET COLORS: PART NUMBER COLOR ID:	● BLK ● RED ● BLU ● GREEN ● WHT ● YEL
---------------------------	-----------------	--------------------	----------------------	---	---------------------------------------

### SERIAL DIGITAL MINI RG59 DUAL SHIELD 4.5 GHZ COAXIAL CABLE

Commercial  
NON-PLENUM



#### Features & Benefits:

- 23 AWG solid annealed bare copper conductor
- Gas injected cellular polyethylene dielectric
- 100% coverage aluminum/poly/aluminum foil inner shield
- 95% coverage tinned copper braid shield
- Flame rated PVC jacket
- 4.5 GHz sweep, very low loss, excellent SRL
- NEC CMR, CEC CMR FT4, RoHS compliant
- 1000 foot spools

#### 23-MINI-SD

##### Application:

- SMPTE serial digital video, AES3id digital audio
- S/PDIF digital audio, subwoofer audio
- All base band video and unbalanced analog audio
- RF modulated signals, CATV, DBS, MATV



NOM OD (INCHES): 0.165	AWG SIZE: 23	# OF PAIRS: N/A	# OF CONDUCTORS 1	AVAILABLE JACKET COLORS: PART NUMBER COLOR ID:	● BLK ● BLU ● RED ● WHT ● GREEN ● YEL
---------------------------	-----------------	--------------------	----------------------	---	---------------------------------------

## SERIAL DIGITAL RG59 DUAL SHIELD TRANSLUCENT 4.5 GHZ COAXIAL CABLE

**Residential**  
**NON-PLENUM**



**Features & Benefits:**

- 20 AWG solid annealed bare copper conductor
- Gas injected cellular polyethylene dielectric
- 100% coverage aluminum/poly/aluminum foil inner shield
- 95% coverage tinned copper braid shield
- Flexible thermoplastic jacket
- 4.5 GHz sweep, very low loss, excellent SRL
- Non-UL, RoHS compliant
- 1000 foot spools

**INTERFLEX-SD**

**Application:**

- SMPTE serial digital video, AES3id digital audio
- S/PDIF digital audio, subwoofer audio
- All base band video and unbalanced analog audio
- RF modulated signals, CATV, DBS, MATV



**PREMIUM CONNECTORS**  
Options for any type of professional installation  
See Page: 117

NOM OD (INCHES): 0.242	AWG SIZE: 20	# OF PAIRS: N/A	# OF CONDUCTORS 1	AVAILABLE JACKET COLORS: PART NUMBER COLOR ID:	● BLK ● BLU ● RED ● WHT
---------------------------	-----------------	--------------------	----------------------	---	-------------------------

## Digital Video Bulk: Plenum Cables

Plenum rated products have passed the highest flame test, NFPA-262. These products have a suffix of "P" after the article code. Some examples of the ratings you will find on the jacket are CL2P, CL3P, CMP, and OFNP. Plenum rated products can go between floors in commercial building where environmental air or air handling requirements exist for those spaces.

Other locations that will commonly call out Plenum requirements are the airspaces between drop ceilings and the actual construction. Plenum ratings are also authorized for in-wall use and plenum is backwards compatible for Riser, General Purpose, and Limited Use. Plenum rated product should never be used as OSP cable.

## SERIAL DIGITAL RG6 DUAL SHIELD 4.5 GHZ PLENUM COAXIAL CABLE

**Commercial**  
**PLENUM**



**Features & Benefits:**

- 18 AWG solid annealed bare copper conductor
- Gas injected cellular fluoropolymer dielectric
- 100% coverage aluminum/poly/aluminum foil inner shield
- 95% coverage tinned copper braid shield
- Plenum rated PVC jacket
- 4.5 GHz sweep, very low loss, excellent SRL
- NEC CMP, CEC CMP FT6, RoHS compliant
- 1000 foot spools

**18-CMP-VID-COAX**

**Application:**

- SMPTE serial digital video, AES3id digital audio
- S/PDIF digital audio, subwoofer audio
- All base band video and unbalanced analog audio
- RF modulated signals, CATV, DBS, MATV

NOM OD (INCHES): 0.237	AWG SIZE: 18	# OF PAIRS: N/A	# OF CONDUCTORS 1	AVAILABLE JACKET COLORS: PART NUMBER COLOR ID:	● BLK ● WHT ● BLU ● GREEN ● RED ● YEL
---------------------------	-----------------	--------------------	----------------------	---	---------------------------------------

## SERIAL DIGITAL RG59 DUAL SHIELD 4.5 GHZ PLENUM COAXIAL CABLE

**Broadcast Quality**  
**PLENUM**



**Features & Benefits:**

- 20 AWG solid annealed bare copper conductor
- Gas injected cellular fluoropolymer dielectric
- 100% coverage aluminum/poly/aluminum foil inner shield
- 95% coverage tinned copper braid shield
- Plenum rated PVC jacket
- 4.5 GHz sweep, very low loss, excellent SRL
- NEC CMP, CEC CMP FT6, RoHS compliant
- 1000 foot spools

**20-CMP-VID-COAX**

**Application:**

- SMPTE serial digital video, AES3id digital audio
- S/PDIF digital audio, subwoofer audio
- All base band video and unbalanced analog audio
- RF modulated signals, CATV, DBS, MATV

NOM OD (INCHES): 0.207	AWG SIZE: 20	# OF PAIRS: N/A	# OF CONDUCTORS 1	AVAILABLE JACKET COLORS: PART NUMBER COLOR ID:	● BLK ● WHT ● BLU ● YEL
---------------------------	-----------------	--------------------	----------------------	---	-------------------------

**SERIAL DIGITAL MINI RG59 DUAL SHIELD 4.5 GHZ PLENUM COAXIAL CABLE**

**Commercial**  
**PLENUM**



**Features & Benefits:**

- 23 AWG solid annealed bare copper conductor
- Gas injected cellular fluoropolymer dielectric
- 100% coverage aluminum/poly/aluminum foil inner shield
- 95% coverage tinned copper braid shield
- Plenum rated PVC jacket
- 4.5 GHz sweep, very low loss, excellent SRL
- NEC CMP, CEC CMP FT6, RoHS compliant
- 1000 foot spools

**23-MINI-CMP**

**Application:**

- SMPTE serial digital video, AES3id digital audio
- S/PDIF digital audio, subwoofer audio
- All base band video and unbalanced analog audio
- RF modulated signals, CATV, DBS, MATV

NOM OD (INCHES): 0.159	AWG SIZE: 23	# OF PAIRS: N/A	# OF CONDUCTORS 1	AVAILABLE JACKET COLORS: ● PART NUMBER COLOR ID: BLK
---------------------------	-----------------	--------------------	----------------------	---



# FIBER OPTIC HDMI

Reliable, time-saving design with no tedious fiber terminations & requires no costly fiber tools

**ENGINEERED FOR INSTALLERS**

The Celerity Detachable Fiber Optic connector supports a thin, durable fiber optic cable in multiple lengths to 1000'. The fiber optics are pre-terminated with a miniature plug (9mm width) which supports fiber optic transfer to and from HDMI.

The use of the miniature plug eliminates the need for time-consuming fiber terminations and the need for costly fiber optic tools. The miniature fiber optic plug securely connects to the Celerity Detachable HDMI connector at the source and display components.

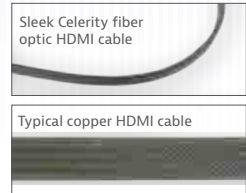

SEE PAGE 105

DFO-1000P



Sleek cable and supports up to 1,000' without loss of signal integrity and HDMI specification

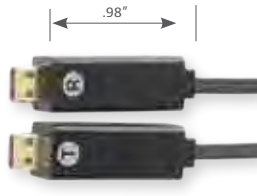

Miniature plug protects the fiber optics & internal electronics and allows for a simple and secure connection



Detachable HDMI connector makes pre-wiring of the fiber optic cable as easy as plug and play



Detachable Fiber Optic HDMI Connector



## “HDMI

Liberty has one of the most extensive HDMI cable offerings in the marketplace. Liberty's HDMI cables offer some of the best shielding in the industry under that plain black wrapper. Besides our standard HDMI cable offering, we now offer locking HDMI technology and fiber HDMI. Our HD Termination System offers an installer the ability to create custom cable lengths and meet any field application that a pre-made HDMI cable won't fit.



## RIBBON CABLE - HD TERMINATION SYSTEM

**HDMI  
NON-PLENUM**

SHOWN WITH SHIELDS STRIPPED  
& PREPPED FOR TERMINATION

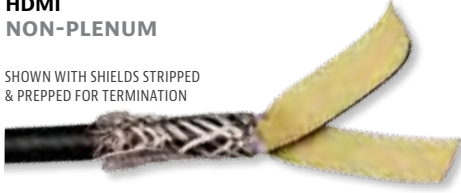

SHOWN WITH SHIELDS



**Features & Benefits:**

- High speed HDMI® with ethernet ATC certification
- Triple shielding (2 foil shields and one braided shield)
- Patented twin ribbon cable design
- Small flexible diameter for tight bends
- UL Listed AWM 20276 for Class 2 device interconnection
- Has to in conduit for in-wall applications per the NEC
- Available in 250 foot and 500 foot Reel-in-Box packages

**DL-HDMCBL**

**Application:**

- 1-5 meters: High Speed HDMI® signals
- 6-9 meters: 1080p24 Standard HDMI Signals
- 10-16 meters: requires extender, 1080p24 standard HDMI
- Rack interconnection, tight space pre-wires
- Specific length runs made to order
- Allows for custom HDMI cable lengths in the field

## PACK OF 10 CONNECTORS & SHELLS - HD TERMINATION SYSTEM

**HDMI  
NON-PLENUM**



**Features & Benefits:**

- Full HDMI® certified connectors
- 7-pieces; Upper connector, lower connector, connector body, black sleeve, white sleeve, upper hood, lower hood
- Packaged in 10-pack unbreakable trays



**DL-HDMCPK**

**Application:**

- Field termination of HD interconnection cables
- Digital multimedia routing and cabling solutions
- Allows for custom HDMI cable lengths in the field

## CRIMP & CUTTING TOOL - HD TERMINATION SYSTEM

**HDMI  
NON-PLENUM**



**Features & Benefits:**

- Ribbon cable cut off slot calibrated to the sleeves
- IDC compression cavity
- Cable strain relief crimp die on the handle

**DL-HDMHT**

**Application:**

- Field termination/crimping of HD Termination System connectors
- Field Termination/cable cutting of HD Termination System ribbon cable
- Digital multimedia routing and cabling solutions
- Allows for custom HDMI cable lengths in the field



**LOCKING HDMI**  
When you lose connectivity  
you lose business!  
See Page: 104

## OPTIONAL EXTENDER - HD TERMINATION SYSTEM

**HDMI  
NON-PLENUM**



**Features & Benefits:**

- For use at display/TV end of the cable run
- HDCP compliant
- HDMI standard speed, 1080p60 5 Gbps, 3D compatible @24hz
- No external power needed - draws power from TV/Display
- Flexible pigtail design approximate length: 6"

**74-005-01**

**Application:**

- Boost and equalization of HDMI after a long cable run
- Boost and equalization of DIY HD terminated cables
- Fix trouble spots caused by passive junction losses



**HDMI MOBILE  
ADAPTER RING  
GENIOUS!**  
See Page: 132



# LOCKING HDMI WHEN YOU LOSE CONNECTIVITY YOU LOSE BUSINESS



Perfect Path's patented locking and high retention HDMI cable series boasts up to 25 lbs of retention, and equipped for 1080p and beyond!



HD-600B      HD-700      HD-1000

SEE PAGE 104 FOR PRODUCT DETAILS

NOW AVAILABLE HERE!



**LIBERTY**  
AV SOLUTIONS  
Distributed Product ★★★

**RUN WITH US**  
www.LibAV.com | 800.530.8998



WATCH IT NOW!  
LOCKING HDMI CABLES

#### AWARD WINNING!

Winner of the 2009 Best Interconnect Device from Insight Media, PerfectPath cables continue to receive rave reviews from users across all audiences, including installers, gamers and HDTV owners.

## LIGHTING & CONTROL

“ Liberty has long been a partner with Lutron® and we offer the full line of matching cables for Lutron® systems. We have also partnered with Litetouch® and carry both the module and station wire. Vantage control cable and DMX-512 duplex in both plenum and non-plenum round out our lighting control cables.

LibertyLinx™ is Liberty's line of OEM matching cables. We meet or exceed the original OEM requirements for Crestron, AMX, Savant and other companies. These also support LUTRON® applications and high power installations.



### Lighting & Control: Non-Plenum Cables

Liberty's definition of non-plenum cable is basically no plenum. We have the following levels grouped under non-plenum so please pay attention to the ratings you need and require:

**RISER:** Signified by the suffix "R" after the article code. These include CL2R, CL3R, CMR, OFNR. The Riser rating indicates the cable has passed the UL1666 flame test. Riser rated cables are backwards compatible to general purpose and limited use cables and Riser ratings are permissible for substitution per the National Electric Code®. Riser rated products can go between floors in commercial building risers as long as there is no environmental air or air handling in those spaces. Riser ratings are authorized for in-wall use.

**GENERAL PURPOSE:** There are two levels of general purpose ratings. Ratings with a suffix of "G" after the article code are certified to the Canadian FT4 flame test. An example is a rating of CMG. If there is no rating suffix at all, such as CL2, CL3, CM, or

OFN then the cable has passed the US UL1685 vertical flame test. General purpose cables are backwards compatible to limited use cables. General purpose ratings are good for single floor use. They cannot be routed between floors except in 1 and 2 family residences.

**LIMITED USE:** Liberty generally does not stock or sell limited use cables. These are signified by a suffix of "X" after the article code. CL2X, CL3X, CMX for example. These are limited to 1 and 2 story, 1 and 2 family residences. They can be used in commercial spaces but only in approved conduit.

**OUTSIDE PLANT:** Also called OSP for short. This is product that has been certified for use in sunlight exposed and direct burial applications outdoors. Liberty OSP products meet all UL requirements for Sunlight Resistance and Direct Burial applications. The products have been tested for UL's crush resistance. At Liberty, we ensure compliance to all code requirements.

#### OEM SYSTEMS LIGHTING CONTROL FOR LUTRON® DIMMER & SWITCH 18 AWG 2 CONDUCTOR 300V CABLE

Lutron®  
NON-PLENUM

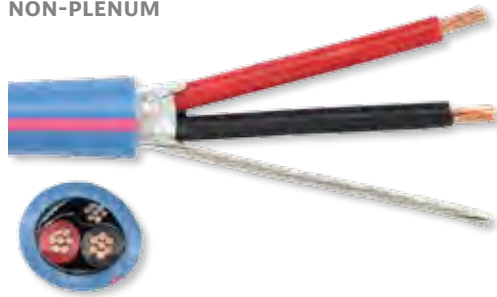

##### Features & Benefits:

- 7 strand annealed bare copper conductors
- Semi rigid PVC insulation
- Twisted & shielded
- Flame rated PVC jacket
- NEC CM, CEC CMG FT4 RoHS compliant
- 1000 foot spools

##### LUTRON-PNK

##### Application:

- OEM systems low voltage dimmer and switch
- Analog line level audio, balanced and unbalanced
- Class 2 and Class 3 low voltage power
- Systems instrumentation and control

NOM OD (INCHES): 0.213	AWG SIZE: 18	# OF PAIRS: N/A	# OF CONDUCTORS 2	AVAILABLE JACKET COLORS:  LIGHT BLUE WITH PINK STRIPE
---------------------------	-----------------	--------------------	----------------------	--

#### OEM SYSTEMS LIGHTING CONTROL FOR LUTRON® DIMMER & SWITCH 18 AWG 4 CONDUCTOR 300V CABLE

Lutron®  
NON-PLENUM

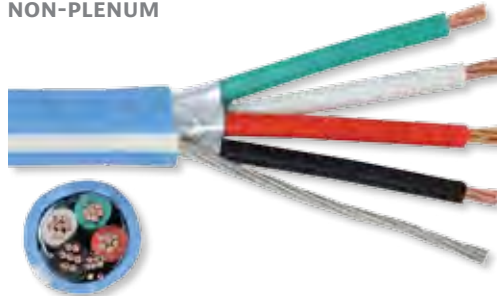

##### Features & Benefits:

- 7 strand annealed bare copper conductors
- Semi rigid PVC insulation
- Twisted & shielded
- Flame rated PVC jacket
- NEC CM, CEC CMG FT4 RoHS compliant
- 1000 foot spools

##### LUTRON-WHT

##### Application:

- OEM systems low voltage dimmer and switch
- Analog line level audio, balanced and unbalanced
- Class 2 and Class 3 low voltage power
- Systems instrumentation and control

NOM OD (INCHES): 0.240	AWG SIZE: 18	# OF PAIRS: N/A	# OF CONDUCTORS 4	AVAILABLE JACKET COLORS:  LIGHT BLUE WITH WHITE STRIPE
---------------------------	-----------------	--------------------	----------------------	---



**BARGAIN BIN!  
PRICES DROP DAILY**  
Check back daily for lower prices on overstock items!  
[www.LibAV.com](http://www.LibAV.com)

## OEM LIGHTING LUTRON® UNIVERSAL CONTROL CABLE KEYPAD

**Lutron**  
NON-PLENUM

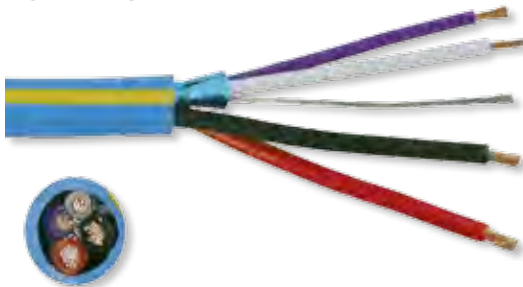

**Features & Benefits:**

- Lutron® universal control and power cable
- Equivalent to GRX-CBL-346S (Keypad)
- Twisted & shielded 22 AWG data pair
- Twisted & unshielded 18 AWG power pair
- Low capacitance data pair under 24 pF/FT
- Flame rated PVC jacket with a yellow stripe
- NEC CM, CEC CMG FT4, RoHS compliant
- 1000 foot spools

**LUTRON-YEL**

**Application:**

- OEM RS-232C, RS-422, and RS-485 data control
- 18 AWG power pair 125 feet for 1 QS drive unit
- Power pair for up to 300 feet
- Class 2 and Class 3 low voltage power
- Systems instrumentation and control

NOM OD (INCHES): 0.230	AWG SIZE: 22/18	# OF PAIRS: 2	# OF CONDUCTORS 4	AVAILABLE JACKET COLORS: LIGHT BLUE WITH YELLOW STRIPE
---------------------------	--------------------	------------------	----------------------	---

## OEM LIGHTING CONTROL FOR LUTRON® UNIVERSAL CONTROL CABLE

**Lutron®**  
NON-PLENUM

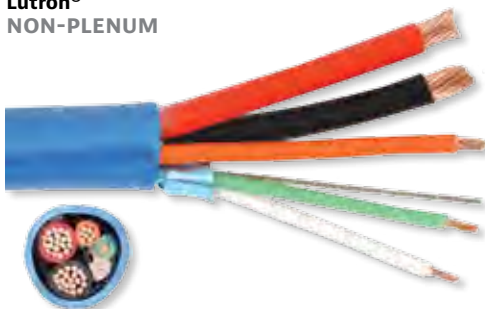

**Features & Benefits:**

- Lutron® universal control and power cable
- Equivalent to GRX-CBL-46L
- Twisted & shielded 22 AWG data pair
- Twisted & unshielded 12 AWG power pair
- Low capacitance data pair under 24 pF/FT
- Flame rated PVC jacket with a blue stripe
- NEC CL3, RoHS compliant
- 1000 foot spools

**LUTRON-RBL**

**Application:**

- Lutron® RS-232C, RS-422, and RS-485 data control
- 12 AWG power pair 500 feet for 1 QS drive unit
- Power pair for up to 1200 feet
- Class 2 and Class 3 low voltage power
- Systems instrumentation and control

NOM OD (INCHES): 0.299	AWG SIZE: 22/18/12	# OF PAIRS: 2	# OF CONDUCTORS 5	AVAILABLE JACKET COLORS: LIGHT BLUE WITH ROYAL BLUE STRIPE
---------------------------	-----------------------	------------------	----------------------	---

## OEM LIGHTING CONTROL FOR LUTRON® SIVOIA® SHADE CONTROL CABLE

**Lutron®**  
NON-PLENUM

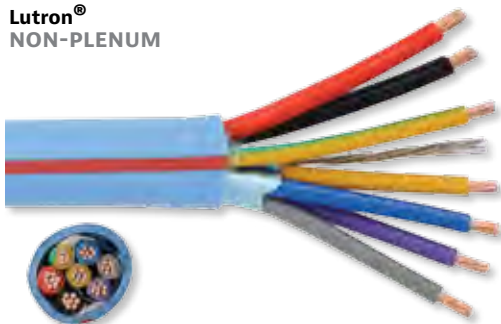

**Features & Benefits:**

- Lutron® control and power cable
- Equivalent to SVQ-CBL
- Twisted & shielded 18 AWG shielded quad
- Twisted & unshielded 16 AWG power pair
- 18 AWG single for sensor wire
- Flame rated PVC jacket with a red stripe
- NEC CM, CEC CMG FT4, RoHS compliant
- 1000 foot spools

**LUTRON-RED**

**Application:**

- Lutron® window drapery motor power and control
- Class 2 and Class 3 low voltage power
- Systems instrumentation and control



**COOL SPOOL SYSTEM®**  
Our exclusive reel box and hand truck means tangle-free pulls and total control  
[See Page: 253](#)

NOM OD (INCHES): 0.340	AWG SIZE: 18/16	# OF PAIRS: 1	# OF CONDUCTORS 7	AVAILABLE JACKET COLORS: LIGHT BLUE WITH ROYAL BLUE STRIPE
---------------------------	--------------------	------------------	----------------------	---

## OEM SYSTEMS LIGHTING CONTROL FOR LUTRON® HOMEWORKS VAREO® CONTROL CABLE

**Lutron**  
NON-PLENUM

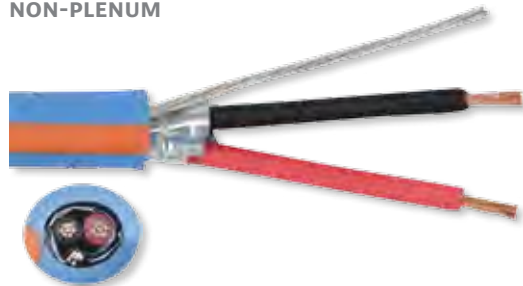

**Features & Benefits:**

- Lutron® universal control and power cable
- HomeWorks® Vareo control cable
- Twisted, shielded 22 AWG data pair
- Low capacitance data pair under 24 pF/FT
- Flame rated PVC jacket with a orange stripe
- NEC CMR, CEC CMG FT4, RoHS compliant
- 1000 foot spools

**LUTRON-ORG**

**Application:**

- OEM RS-232C, RS-422, and RS-485 data control
- Analog line level audio, balanced and unbalanced
- Class 2 and Class 3 low voltage power
- Systems instrumentation and control

NOM OD (INCHES): 0.185	AWG SIZE: 22	# OF PAIRS: 1	# OF CONDUCTORS 2	AVAILABLE JACKET COLORS: LIGHT BLUE WITH ORANGE STRIPE
---------------------------	-----------------	------------------	----------------------	---

## OEM SYSTEMS LIGHTING CONTROL FOR LUTRON® ECOSYSTEMS® SENSOR CABLE

**Lutron**  
NON-PLENUM

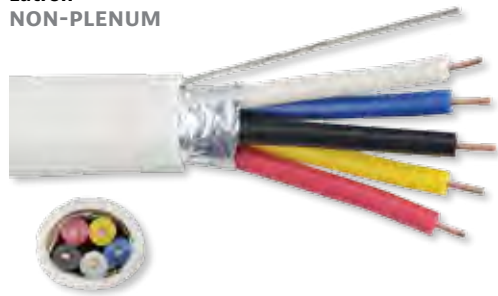

**Features & Benefits:**

- Lutron® EcoSystems® bus cable
- Equivalent to C-CBL-522S-WH-STET
- 22 AWG solid annealed bare copper
- PVC insulation with special color code
- Twisted & shielded
- Flame rated PVC jacket
- NEC CM, CEC CM FT1, RoHS compliant
- AWM 20811 600V 105 °C for lighting pendant use
- 1000 foot spools

**LUTRON-ESC**

**Application:**

- OEM Ballast system sensor cable
- AWM rating cannot be used with CM rating
- Class 2 and Class 3 low voltage power
- Systems instrumentation and control



**PANEL CRAFTERS**  
**CUSTOM & STOCK PLATES & PANELS**  
Page 211

NOM OD (INCHES): 0.293	AWG SIZE: 22	# OF PAIRS: N/A	# OF CONDUCTORS 5	AVAILABLE JACKET COLORS: ● GRY
---------------------------	-----------------	--------------------	----------------------	-----------------------------------

## OEM LIGHTING CONTROL FOR LUTRON® QUANTUM CABLE

**Lutron®**  
NON-PLENUM

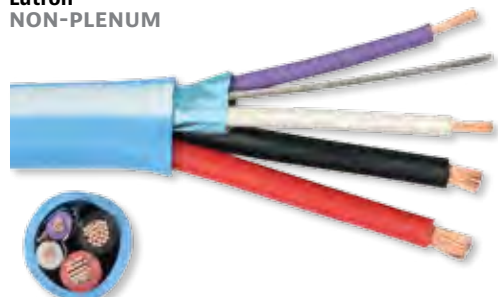

**Features & Benefits:**

- Lutron® universal control and power cable
- Equivalent to QSH-CBL-M
- Twisted & shielded 22 AWG data pair
- Twisted & unshielded 16 AWG power pair
- low capacitance data pair under 24 pF/FT
- Flame rated PVC jacket with a white stripe
- NEC CM, CEC CMG FT4, RoHS compliant
- 1000 foot spools

**LUTRON-QSC**

**Application:**

- Lutron® RS-232C, RS-422, and RS-485 data control
- 16 AWG power pair 200 feet for 1 QS drive unit
- Power pair for up to 500 feet
- Class 2 and Class 3 low voltage power
- Systems instrumentation and control

NOM OD (INCHES): 0.240	AWG SIZE: 22/16	# OF PAIRS: 2	# OF CONDUCTORS 4	AVAILABLE JACKET COLORS: ■■■■■ LIGHT BLUE WITH WHITE STRIPE
---------------------------	--------------------	------------------	----------------------	--

## OEM SYSTEMS LIGHTING CONTROL FOR LUTRON® ECOSYSTEMS® BUS CABLE

**Lutron**  
NON-PLENUM



**Features & Benefits:**

- Lutron® EcoSystems® bus cable
- Equivalent to C-CBL-216SR-GY
- 16 AWG solid annealed bare copper
- PVC insulation with special color code
- Twisted & unshielded
- Flame rated PVC jacket
- NEC CM, CEC CM FT1, RoHS compliant
- AWM 20811 600V 105 °C for lighting pendant use
- 1000 foot spools

**LUTRON-EBC**

**Application:**

- OEM ballast system bus cable
- AWM rating cannot be used with CM rating
- Class 2 and Class 3 low voltage power
- Systems instrumentation and control

NOM OD (INCHES): 0.282	AWG SIZE: 16	# OF PAIRS: N/A	# OF CONDUCTORS 2	AVAILABLE JACKET COLORS: ● GRY
---------------------------	-----------------	--------------------	----------------------	-----------------------------------

## OEM LIGHTING CONTROL FOR LUTRON® UNIVERSAL CONTROL CABLE

**Commercial**  
NON-PLENUM

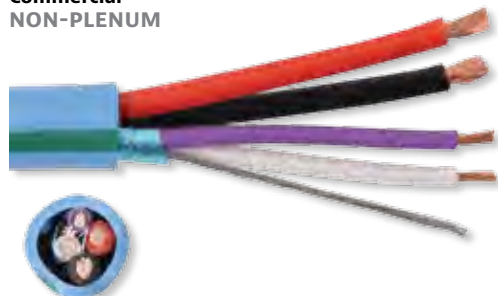

**Features & Benefits:**

- Lutron® universal control and power cable
- Equivalent to GRX-CBL-346S (Grafik Eye)
- Twisted & shielded 22 AWG data pair
- Twisted & unshielded 18 AWG power pair
- Low capacitance data pair under 24 pF/FT
- Flame rated PVC jacket with a green stripe
- NEC CM, CEC CMG FT4, RoHS compliant
- 1000 foot spools

**LUTRON-GRN**

**Application:**

- Lutron® RS-232C, RS-422, and RS-485 data control
- Power pair for up to 300 watts
- Class 2 and Class 3 low voltage power
- Systems instrumentation and control

NOM OD (INCHES): 0.230	AWG SIZE: 22/18	# OF PAIRS: 2	# OF CONDUCTORS 4	AVAILABLE JACKET COLORS: ■■■■■ LIGHT BLUE WITH GREEN STRIPE
---------------------------	--------------------	------------------	----------------------	--

## Lighting & Control: Plenum Cables

Plenum rated products have passed the highest flame test, NFPA-262. These products have a suffix of "P" after the article code. Some examples of the ratings you will find on the jacket are CL2P, CL3P, CMP, and OFNP. Plenum rated products can go between floors in commercial building where environmental air or air handling requirements exist for those spaces.

Other locations that will commonly call out Plenum requirements are the airspaces between drop ceilings and the actual construction. Plenum ratings are also authorized for in-wall use and plenum is backwards compatible for Riser, General Purpose, and Limited Use. Plenum rated product should never be used as OSP cable.

### OEM LIGHTING LUTRON® UNIVERSAL PLENUM CONTROL CABLE KEYPAD

**Lutron®**  
**PLENUM**

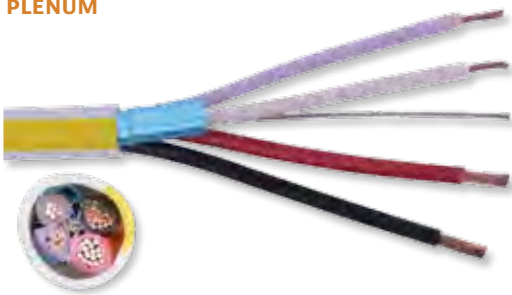

#### Features & Benefits:

- Lutron® universal control and power cable
- Equivalent to GRX-PCBL-346S (Keypad)
- Twisted & shielded 22 AWG data pair
- Twisted & unshielded 18 AWG power pair
- Low capacitance data pair under 24 pF/FT
- Plenum rated PVC jacket with a yellow stripe
- NEC CMP, CEC CMP FT6, RoHS compliant
- 1000 foot spools

#### LUTRON-P-YEL

##### Application:

- Lutron® RS-232C, RS-422, and RS-485 data control
- 18 AWG power pair 125 feet for 1 QS drive unit
- Power pair for up to 300 feet
- Class 2 and Class 3 low voltage power
- Systems instrumentation and control

NOM OD (INCHES):  
0.195

AWG SIZE:  
22/18

# OF PAIRS:  
2

# OF CONDUCTORS  
4

AVAILABLE JACKET COLORS:   
WHITE WITH YELLOW STRIPE

### OEM SYSTEMS LIGHTING CONTROL FOR LUTRON® UNIVERSAL CONTROL PLENUM CABLE

**Lutron**  
**PLENUM**

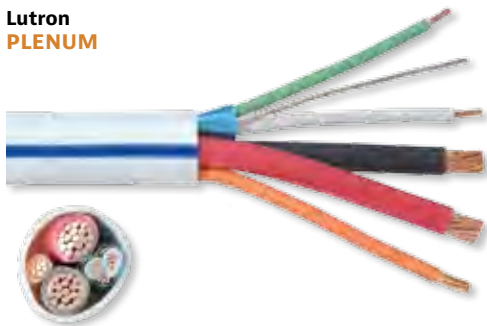

#### Features & Benefits:

- Lutron® universal control and power cable
- Equivalent to GRX-PCBL-46L
- Twisted & shielded 22 AWG data pair
- Twisted & unshielded 12 AWG power pair
- Low capacitance data pair under 24 pF/FT
- Plenum rated PVC jacket with a blue stripe
- NEC CL3P, RoHS compliant
- 1000 foot spools

#### LUTRON-P-RBL

##### Application:

- OEM RS-232C, RS-422, and RS-485 data control
- 12 AWG power pair 500 feet for 1 QS drive unit
- Power pair for up to 1200 feet
- Class 2 and Class 3 low voltage power
- Systems instrumentation and control

NOM OD (INCHES):  
0.272

AWG SIZE:  
22/18/12

# OF PAIRS:  
2

# OF CONDUCTORS  
5

AVAILABLE JACKET COLORS:   
WHITE WITH A ROYAL BLUE STRIPE

### OEM SYSTEMS LIGHTING CONTROL FOR LUTRON® SIVOIA SHADE CONTROL PLENUM CABLE

**Lutron**  
**PLENUM**

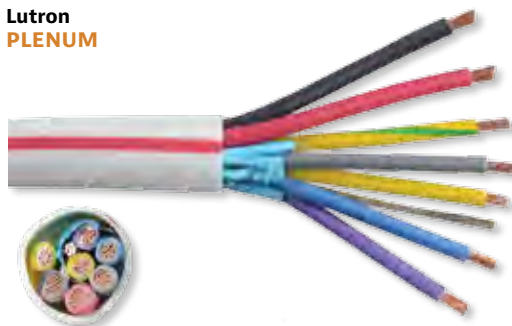

#### Features & Benefits:

- Lutron® control and power cable
- Equivalent to SVQ-PCBL
- Twisted & shielded 18 AWG shielded quad
- Twisted & unshielded 16 AWG power pair
- 18 AWG single for sensor wire
- Plenum rated PVC jacket with a red stripe
- NEC CMP, CEC CMP FT6, RoHS compliant
- 1000 foot spools

#### LUTRON-P-RED

##### Application:

- OEM window drapery motor power and control
- Class 2 and Class 3 low voltage power
- Systems instrumentation and control



#### CUSTOMER SERVICE

We offer technical assistance on all of our products or applications! Call us at 800-530-899 or email: [orders@LibAV.com](mailto:orders@LibAV.com)

NOM OD (INCHES):  
0.322

AWG SIZE:  
18/16

# OF PAIRS:  
1

# OF CONDUCTORS  
7

AVAILABLE JACKET COLORS:   
WHITE WITH A RED STRIPE

## OEM SYSTEMS LIGHTING CONTROL FOR LUTRON® QUANTUM PLENUM CABLE

Lutron®  
PLENUM

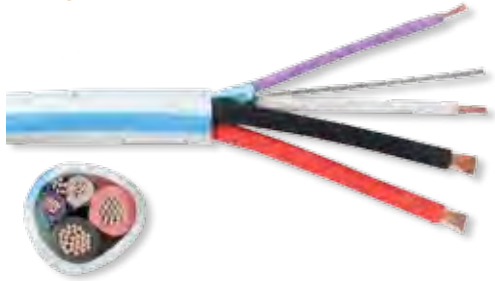

### Features & Benefits:

- Lutron® universal control and power cable
- Equivalent to QSH-CBL-M
- Twisted & shielded 22 AWG data pair
- Twisted & unshielded 16 AWG power pair
- Low capacitance data pair under 24 pF/FT
- Plenum rated PVC jacket with a lt. blue stripe
- NEC CMP, CEC CMP FT6, RoHS compliant
- 1000 foot spools

### LUTRON-P-QSC

#### Application:

- Lutron® RS-232C, RS-422, and RS-485 data control
- 16 AWG power pair 200 feet for 1 QS drive unit
- Power pair for up to 500 feet
- Class 2 and Class 3 low voltage power
- Systems instrumentation and control

NOM OD (INCHES): 0.206	AWG SIZE: 22/16	# OF PAIRS: 2	# OF CONDUCTORS 4	AVAILABLE JACKET COLORS:  LIGHT BLUE WITH WHITE STRIPE
---------------------------	--------------------	------------------	----------------------	--

## OEM LIGHTING LUTRON® UNIVERSAL PLENUM CONTROL CABLE GRAFIK EYE

Lutron  
PLENUM

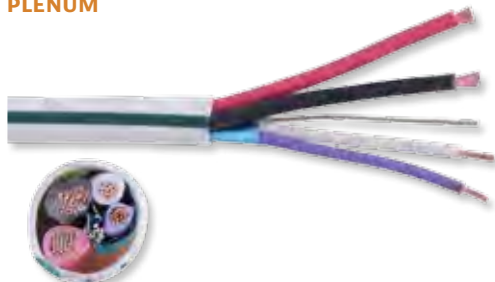

### Features & Benefits:

- Lutron® universal control and power cable
- Equivalent to GRX-PCBL-346S (Grafik Eye)
- Twisted & shielded 22 AWG data pair
- Twisted & unshielded 18 AWG power pair
- Low capacitance data pair under 24 pF/FT
- Plenum rated PVC jacket with a green stripe
- NEC CMP, CEC CMP FT6, RoHS compliant
- 1000 foot spools

### LUTRON-P-GRN

#### Application:

- OEM RS-232C, RS-422, and RS-485 data control
- 18 AWG power pair 125 feet for 1 QS drive unit
- Power pair for up to 300 feet
- Class 2 and Class 3 low voltage power
- Systems instrumentation and control

NOM OD (INCHES): 0.195	AWG SIZE: 22/18	# OF PAIRS: 2	# OF CONDUCTORS 4	AVAILABLE JACKET COLORS:  WHITE WITH GREEN STRIPE
---------------------------	--------------------	------------------	----------------------	---

## OEM SYSTEMS LIGHTING CONTROL FOR LUTRON® ECOSYSTEMS® PLENUM BUS CABLE

Lutron®  
PLENUM



### Features & Benefits:

- Lutron® EcoSystems® bus cable
- Equivalent to C-PCBL-216S-CL-1
- 16 AWG solid annealed bare copper
- Fluoropolymer insulation with special color code
- Twisted & unshielded
- Plenum rated fluoropolymer jacket
- NEC CMP, CEC CMP FT6, RoHS compliant
- 1000 foot spools

### LUTRON-P-EBC

#### Application:

- Lutron® ballast system bus cable
- Class 2 and Class 3 low voltage power
- Systems instrumentation and control

NOM OD (INCHES): 0.158	AWG SIZE: 16	# OF PAIRS: N/A	# OF CONDUCTORS 2	AVAILABLE JACKET COLORS: <input type="radio"/> CLEAR
---------------------------	-----------------	--------------------	----------------------	--

**THE LIBERTY**  
**EDGE** **MONEY-SAVING SERVICES!**  
Go to [www.LibAV.com](http://www.LibAV.com) or contact your rep today to make Liberty an extension of your workforce!

## OEM SYSTEMS LIGHTING CONTROL FOR LUTRON® ECOSYSTEMS® PLENUM SENSOR CABLE

Lutron®  
PLENUM

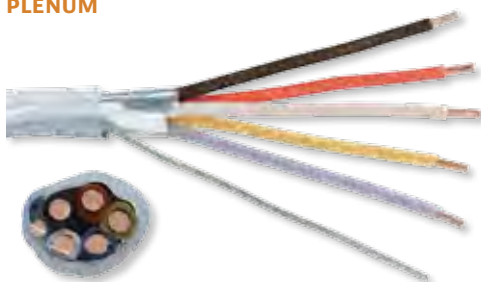

### Features & Benefits:

- Lutron® EcoSystems® sensor
- Equivalent to C-PCBL-522S-WH-1
- 22 AWG solid annealed bare copper
- Fluoropolymer insulation with special color code
- Twisted & shielded
- Plenum rated fluoropolymer jacket
- NEC CMP, CEC CMP FT6, RoHS compliant
- 1000 foot spools

### LUTRON-P-ESC

#### Application:

- Lutron® ballast system sensor cable
- Class 2 and Class 3 low voltage power
- Systems instrumentation and control

NOM OD (INCHES): 0.134	AWG SIZE: 22	# OF PAIRS: N/A	# OF CONDUCTORS 5	AVAILABLE JACKET COLORS: <input type="radio"/> CLEAR
---------------------------	-----------------	--------------------	----------------------	--

## DIGITAL MEDIA LLINX-U AND 2 U/UTP CATEGORY 5E COMPOSITE CABLE

**Crestron**  
NON-PLENUM

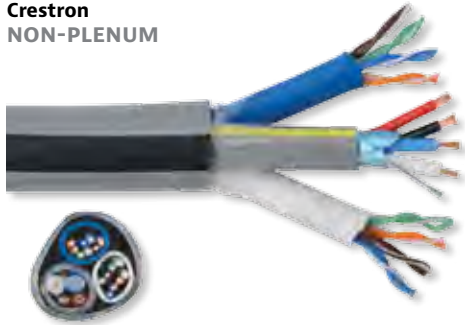

**Features & Benefits:**

- LibertyLinx® OEM support cable
- Liberty Universal Control and 2 Category 5e under one jacket
- Flame rated PVC jacket
- NEC CM, CEC CMG FT4, RoHS compliant
- 1000 foot spools

**LLINX-D**

**Application:**

- OEM RS-232C, RS-422, and RS-485 data control
- Power pair for up to 300 watts
- Touchscreen video and control
- Class 2 and Class 3 low voltage power
- Systems instrumentation and control

NOM OD (INCHES): 0.543	AWG SIZE: 24/22/18	# OF PAIRS: 6	# OF CONDUCTORS 12	AVAILABLE JACKET COLORS: GRAY WITH BLACK STRIPE
---------------------------	-----------------------	------------------	-----------------------	--

## DIGITAL MEDIA LLINX-U AND U/UTP CATEGORY 5E COMPOSITE CABLE

**Crestron**  
NON-PLENUM

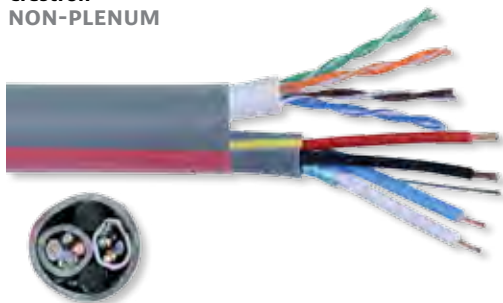

**Features & Benefits:**

- LibertyLinx® OEM support cable
- Liberty universal control and Category 5e under one jacket
- Flame rated PVC jacket
- NEC CM, CEC CMG FT4, RoHS compliant
- 1000 foot spools

**LLINX-CR**

**Application:**

- OEM RS-232C, RS-422, and RS-485 data control
- Power pair for up to 300 watts
- Touchscreen video and control
- Class 2 and Class 3 low voltage power
- Systems instrumentation and control

NOM OD (INCHES): 0.504	AWG SIZE: 22/18/24	# OF PAIRS: 6	# OF CONDUCTORS 12	AVAILABLE JACKET COLORS: GRAY WITH RED STRIPE
---------------------------	-----------------------	------------------	-----------------------	--

## DIGITAL MEDIA LLINX-U AND 4 U/UTP CATEGORY 5E COMPOSITE CABLE

**Crestron**  
NON-PLENUM

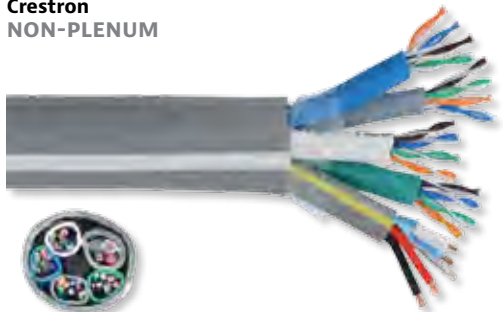

**Features & Benefits:**

- LibertyLinx® OEM support cable
- Liberty universal control and 4 Category 5e under one jacket
- Flame rated PVC jacket
- NEC CM, CEC CMG FT4, RoHS compliant
- 1000 foot spools

**LLINX-Q**

**Application:**

- OEM RS-232C, RS-422, and RS-485 data control
- Power pair for up to 300 watts
- Touchscreen video and control
- Class 2 and Class 3 low voltage power
- Systems instrumentation and control

NOM OD (INCHES): 0.400	AWG SIZE: 24/22/18	# OF PAIRS: 6	# OF CONDUCTORS 12	AVAILABLE JACKET COLORS: GRAY WITH WHITE STRIPE
---------------------------	-----------------------	------------------	-----------------------	--

## OEM SYSTEMS UNIVERSAL CONTROL 22 AWG 1 PAIR SHIELDED AND 18 AWG 2 CONDUCTOR COMPOSITE CABLE

**Commercial**  
NON-PLENUM

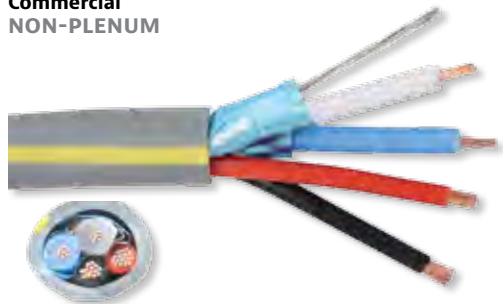

**Features & Benefits:**

- LibertyLinx® universal control and power cable
- Twisted & shielded 22 AWG data pair
- Twisted & unshielded 18 AWG power pair
- 12.5 pF/FT 105 ohm digital data pair
- Flame rated PVC jacket
- NEC CM, CEC CMG FT4, RoHS compliant
- 1000 foot spools

**LLINX-U**

**Application:**

- OEM RS-232C, RS-422 and RS-485 data control
- Power pair for up to 300 watts
- Class 2 and Class 3 low voltage power
- Systems instrumentation and control

NOM OD (INCHES): 0.246	AWG SIZE: 22/18	# OF PAIRS: 2	# OF CONDUCTORS 4	AVAILABLE JACKET COLORS: GRAY WITH YELLOW STRIPE
---------------------------	--------------------	------------------	----------------------	---

## OEM SYSTEMS UNIVERSAL CONTROL 22 AWG 1 PAIR SHIELDED AND 12 AWG 2 CONDUCTOR COMPOSITE CABLE

**Universal**  
**NON-PLENUM**

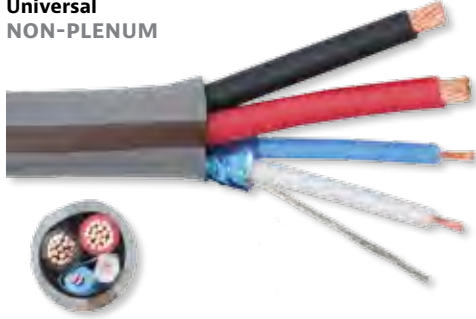

**Features & Benefits:**

- LibertyLinx® universal control and power cable
- Twisted & shielded 22 AWG data pair
- Twisted & unshielded 12 AWG power pair
- 12.5 pF/FT 105 ohm digital data pair
- Flame rated PVC jacket
- NEC CM, CEC CMG FT4, RoHS compliant
- 1000 foot spools
- Direct drop in for LUTRON® QSH-CBL-L

**LLINX-U-HP**

**Application:**

- OEM RS-232C, RS-422 and RS-485 data control
- Power pair for over 300 watts and long distance
- Class 2 and Class 3 low voltage power
- Systems instrumentation and control

NOM OD (INCHES): 0.315	AWG SIZE: 22/12	# OF PAIRS: 2	# OF CONDUCTORS 4	AVAILABLE JACKET COLORS: GRAY WITH A BROWN STRIPE
---------------------------	--------------------	------------------	----------------------	--

## DIGITAL MEDIA 24 AWG 4 PAIR DUAL SHIELDED HDBASET CABLE

**Lutron**  
**NON-PLENUM**

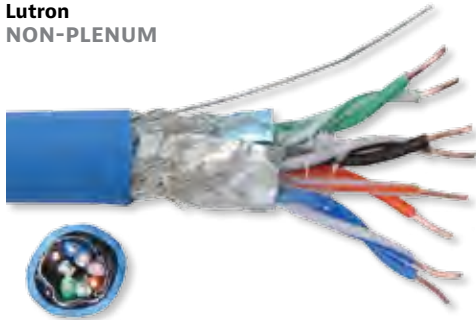

**Features & Benefits:**

- LibertyLinx™ LUTRON® support cable
- Dual shielded high bandwidth Category 5e type SF/UTP cable
- Flame rated PVC jacket
- NEC CM, CEC CMG FT4, RoHS compliant
- 1000 foot spools

**LLINX-HD**

**Application:**

- HDBaseT systems infrastructure cable for LUTRON® systems
- Digital multimedia distribution and routing
- Class 2 and Class 3 low voltage power
- Systems instrumentation and control

NOM OD (INCHES): 0.244	AWG SIZE: 24	# OF PAIRS: 4	# OF CONDUCTORS 8	AVAILABLE JACKET COLORS: ● PART NUMBER COLOR ID: BLU
---------------------------	-----------------	------------------	----------------------	---

## OEM SYSTEMS UNIVERSAL CONTROL 22 AWG 1 PAIR SHIELDED AND 18 AWG 2 CONDUCTOR COMPOSITE OUTSIDE PLANT CABLE

**Universal**  
**DIRECT BURIAL**

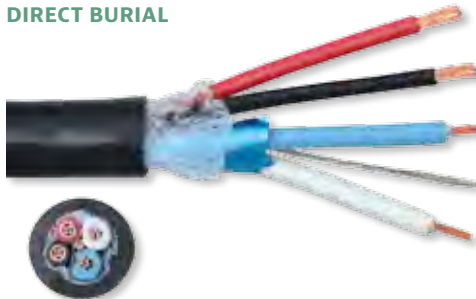

**Features & Benefits:**

- LibertyLinx® universal control and power cable
- Twisted & shielded 22 AWG data pair
- Twisted & unshielded 18 AWG power pair
- 12.5 pF/FT 105 ohm digital data pair
- UV stabilized PVC jacket
- Direct burial, sunlight resistant, RoHS compliant
- 1000 foot spools

**LLINX-U-DB**

**Application:**

- OEM RS-232C, RS-422, and RS-485 data control
- Power pair for up to 300 watts
- Class 2 and Class 3 low voltage power
- Systems instrumentation and control



**BARGAIN BIN!**  
**PRICES DROP DAILY**  
Check back daily for lower prices on overstock items!  
[www.LibAV.com](http://www.LibAV.com)

NOM OD (INCHES): 0.273	AWG SIZE: 22/18	# OF PAIRS: 2	# OF CONDUCTORS 4	AVAILABLE JACKET COLORS: ● BLACK
---------------------------	--------------------	------------------	----------------------	-------------------------------------

## OEM SYSTEMS UNIVERSAL CONTROL 22 AWG 1 PAIR SHIELDED AND 18 AWG 2 CONDUCTOR COMPOSITE PLENUM CABLE

**Universal**  
**PLENUM**



**Features & Benefits:**

- LibertyLinx® universal control and power cable
- Twisted & shielded 22 AWG data pair
- Twisted & unshielded 18 AWG power pair
- 12.5 pF/FT 105 ohm digital data pair
- Plenum rated PVC jacket
- NEC CMP, CEC CMP FT6, RoHS compliant
- 1000 foot spools

**LLINX-U-P**

**Application:**

- OEM RS-232C, RS-422 and RS-485 data control
- Power pair for up to 300 watts
- Class 2 and Class 3 low voltage power
- Systems instrumentation and control

NOM OD (INCHES): 0.205	AWG SIZE: 22/18	# OF PAIRS: 2	# OF CONDUCTORS 4	AVAILABLE JACKET COLORS: ● GRAY
---------------------------	--------------------	------------------	----------------------	------------------------------------



## CRESTRON® LLINX-U AND LOW SKEW U/UTP CATEGORY 5E COMPOSITE PLENUM CABLE IN 2 OUTER JACKETS

**Crestron**  
**PLENUM**

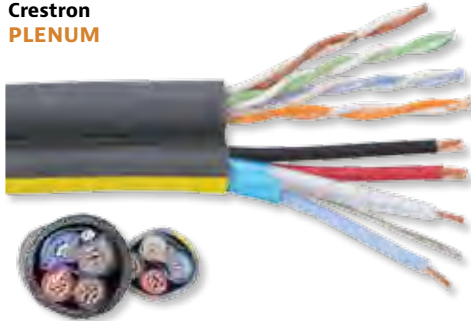

**Features & Benefits:**

- LibertyLinx® OEM support cable
- Liberty Universal Control and a low skew Category 5e
- Both components in parallel (SPT) and joined by a web
- Plenum rated PVC jacket
- NEC CMP, CEC CMP FT6, RoHS compliant
- 1000 foot spools

**LLINX-QM-P**

**Application:**

- OEM RS-232C, RS-422, and RS-485 data control
- Power pair for up to 300 watts
- Touchscreen video and control
- Class 2 and Class 3 low voltage power
- Systems instrumentation and control

NOM OD (INCHES): 0.400	AWG SIZE: 24/22/18	# OF PAIRS: 6	# OF CONDUCTORS 12	AVAILABLE JACKET COLORS: GRAY WITH YELLOW STRIPE
---------------------------	-----------------------	------------------	-----------------------	---

## OEM SYSTEMS LIGHTING CONTROL FOR LUTRON® DIMMER & SWITCH 18 AWG 2 CONDUCTOR 600V TRAY CABLE

**Lutron®**  
**NON-PLENUM**



**Features & Benefits:**

- 7 strand annealed bare copper conductors
- Semi rigid PVC insulation with outer nylon sheathing
- Twisted & shielded
- Flame rated PVC jacket
- NEC TC, direct burial, sunlight resistant, RoHS compliant
- 1000 foot spools

**18-2C-TRSH**

**Application:**

- OEM systems line voltage dimmer and switch
- Tray cable 600V application
- Outdoor speaker, direct burial and exposed
- 600V Instrumentation and control



**New Website**  
[www.LibAV.com](http://www.LibAV.com)  
**BETTER, STRONGER, EXPANSIVE!**

NOM OD (INCHES): 0.270	AWG SIZE: 18	# OF PAIRS: N/A	# OF CONDUCTORS 2	AVAILABLE JACKET COLORS: LIGHT BLUE
---------------------------	-----------------	--------------------	----------------------	--

## OEM SYSTEMS LIGHTING CONTROL FOR LUTRON® DIMMER & SWITCH 18 AWG 4 CONDUCTOR 600V TRAY CABLE

**Lutron®**  
**NON-PLENUM**

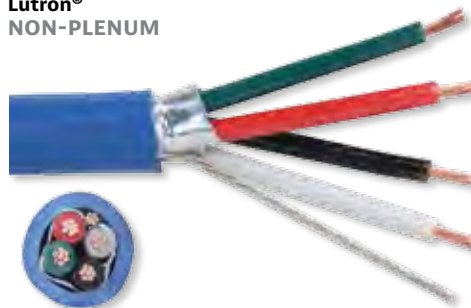

**Features & Benefits:**

- 7 strand annealed bare copper conductors
- Semi rigid PVC insulation with outer nylon sheathing
- Twisted & shielded
- Flame rated PVC jacket
- NEC TC, direct burial, sunlight resistant, RoHS compliant
- 1000 foot spools

**18-4C-TRSH**

**Application:**

- OEM systems line voltage dimmer and switch
- Tray cable 600V application
- Outdoor speaker, direct burial and exposed
- 600V Instrumentation and control

NOM OD (INCHES): 0.321	AWG SIZE: 18	# OF PAIRS: N/A	# OF CONDUCTORS 4	AVAILABLE JACKET COLORS: LIGHT BLUE
---------------------------	-----------------	--------------------	----------------------	--

## DMX-512 CONTROL AND DATA 24 AWG 2 PAIR CABLE

**DMX**  
**PLENUM**



**Features & Benefits:**

- 7 strand annealed tinned copper conductors
- Cellular fluoropolymer dielectric insulation
- 2 pairs tightly twisted and overall shielded
- Dual 100% foil and 90% tinned copper braid shield
- Plenum rated PVC jacket
- 120 ohm impedance, 11.2 pF/FT ultra low capacitance
- NEC CMP, CEC CMP FT6, RoHS compliant
- 1000 foot spools

**24-2P-P485**

**Application:**

- Full duplex RS-485, DMX-512 digital lighting control
- AES/EBU digital audio, line level, microphone audio
- Balanced and unbalanced audio formats
- Infrared (IR), RS-232C signaling
- Instrumentation and control

NOM OD (INCHES): 0.277	AWG SIZE: 24	# OF PAIRS: 2	# OF CONDUCTORS 4	AVAILABLE JACKET COLORS: PART NUMBER COLOR ID: WHT
---------------------------	-----------------	------------------	----------------------	---

## AMX UNIVERSAL CONTROL 22 AWG 1 PAIR SHIELDED AND 18 AWG 2 CONDUCTOR COMPOSITE CABLE

**AMX**  
NON-PLENUM

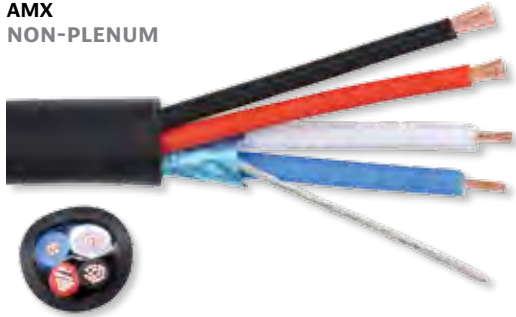

**Features & Benefits:**

- AMX AXLINK by Liberty
- Universal control and power cable
- Twisted & shielded 22 AWG data pair
- Twisted & unshielded 18 AWG power pair
- 12.5 pF/FT 105 ohm digital data pair
- Flame rated PVC jacket
- NEC CM, CEC CMG FT4, RoHS compliant
- 1000 foot spools

**AXLINK**

**Application:**

- OEM RS-232C, RS-422, and RS-485 data control
- Power pair for up to 300 watts
- Class 2 and Class 3 low voltage power
- Systems instrumentation and control

NOM OD (INCHES): 0.246	AWG SIZE: 22/8	# OF PAIRS: 2	# OF CONDUCTORS 4	AVAILABLE JACKET COLORS: ●
				PART NUMBER COLOR ID: BLK

## AMX UNIVERSAL CONTROL 22 AWG 1 PAIR SHIELDED AND 18 AWG 2 CONDUCTOR COMPOSITE PLENUM CABLE

**AMX**  
PLENUM

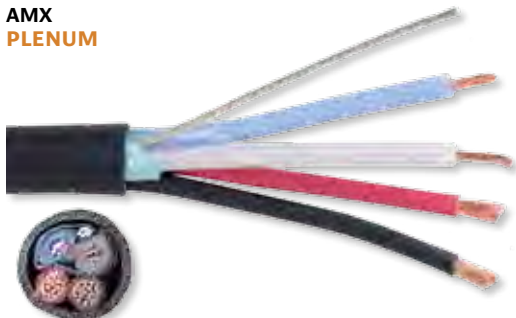

**Features & Benefits:**

- AMX AXLINK by Liberty
- Universal control and power cable
- Twisted & shielded 22 AWG data pair
- Twisted & unshielded 18 AWG power pair
- 12.5 pF/FT 105 ohm digital data pair
- Plenum rated PVC jacket
- NEC CMP, CEC CMP FT6, RoHS compliant
- 1000 foot spools

**AXLINK-P**

**Application:**

- OEM RS-232C, RS-422, and RS-485 data control
- Power pair for up to 300 watts
- Class 2 and Class 3 low voltage power
- Systems instrumentation and control

NOM OD (INCHES): 0.215	AWG SIZE: 22/8	# OF PAIRS: 2	# OF CONDUCTORS 4	AVAILABLE JACKET COLORS: ●
				PART NUMBER COLOR ID: BLK

## ELAN® RG59 CCTV AND 18/2 POWER AND U/UTP CATEGORY 5E COMPOSITE CABLE

**Elan®**  
NON-PLENUM



**Features & Benefits:**

- Elan® home systems security composite
- RG59 baseband coax, 18 AWG 2 pair unshielded & U/UTP category 5e cable under one jacket
- Flame rated PVC jacket
- NEC CM, CEC CMG FT4, RoHS compliant
- 1000 foot spools

**ELAN-CM-VIA**

**Application:**

- OEM systems security system cable
- Baseband video, IP video and Pan/Tilt/Zoom security in one
- Class 2 and Class 3 low voltage power
- Systems instrumentation and control



NOM OD (INCHES): 0.492	AWG SIZE: 24/20/18	# OF PAIRS: 4	# OF CONDUCTORS 11	AVAILABLE JACKET COLORS: ●
				PART NUMBER COLOR ID: PUR

## OEM SYSTEMS LIGHTING CONTROL FOR VANTAGE® 16 AWG 2 CONDUCTOR 300V LOW CAPACITANCE CABLE

**Vantage®**  
NON-PLENUM

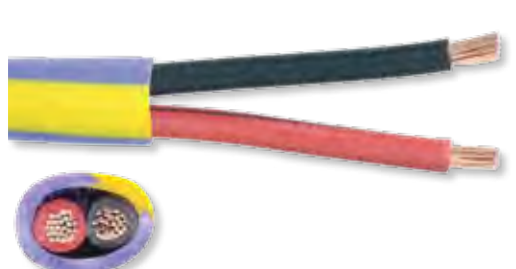

**Features & Benefits:**

- 26 strand annealed bare copper conductors
- Semi rigid PVC insulation
- Twisted & unshielded
- Flame rated PVC jacket
- NEC CMR, CEC CMR FT4, RoHS compliant
- 1000 foot spools

**16-2C-VAN**

**Application:**

- OEM systems bus cable for lighting control
- Speaker level audio, 70 volt speaker cabling
- Class 2 and Class 3 low voltage power
- Instrumentation and control

NOM OD (INCHES): 0.252	AWG SIZE: 16	# OF PAIRS: N/A	# OF CONDUCTORS 2	AVAILABLE JACKET COLORS:
				PART NUMBER COLOR ID: PURPLE WITH A YELLOW STRIPE

## LITE TOUCH® 16 AWG 4 CONDUCTOR SHIELDED PLTC STATION WIRE CABLE

**Lite Touch**  
NON-PLENUM

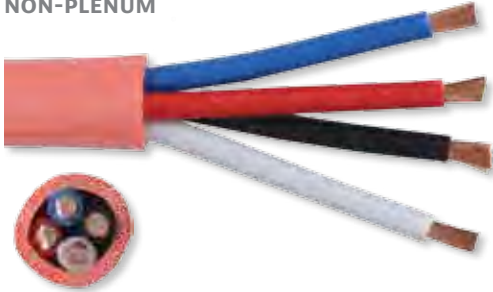

**Features & Benefits:**

- 16 AWG 65 strand annealed bare copper conductors
- PVC insulation
- Special color code for the Lite Touch® system
- Twisted & unshielded
- UV stabilized PVC jacket
- NEC PLTC, sunlight resistant, direct burial, RoHS compliant
- 1000 foot spools

**LITE-TOUCH-SW**

**Application:**

- OEM low voltage module cable for long runs
- Station wire for runs over 30 feet
- Class 2 and Class 3 low voltage power
- Systems instrumentation and control



**TOOLS & ACCESSORIES**  
Save time and money!  
See Page: 247

NOM OD (INCHES): 0.300	AWG SIZE: 16	# OF PAIRS: N/A	# OF CONDUCTORS 4	AVAILABLE JACKET COLORS: ● PART NUMBER COLOR ID: ORG
---------------------------	-----------------	--------------------	----------------------	---

## LITE TOUCH® 22 AWG 4 CONDUCTOR SHIELDED PLTC MODULE CABLE

**Lite Touch®**  
NON-PLENUM

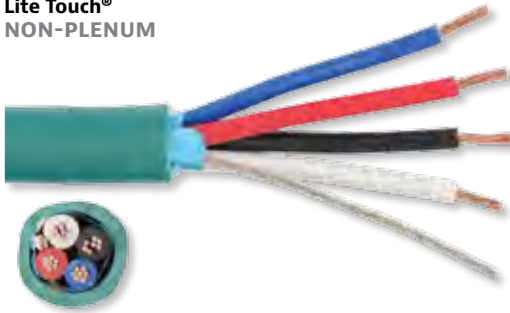

**Features & Benefits:**

- 22 AWG 7 strand annealed bare copper conductors
- PVC insulation
- Special color code for the Lite Touch® system
- Twisted & shielded
- UV stabilized PVC jacket
- NEC PLTC, sunlight resistant, direct burial, RoHS compliant
- 1000 foot spools

**LITE-TOUCH-MODULE**

**Application:**

- OEM low voltage module cable for short runs
- Module typically under 30 foot runs
- Class 2 and Class 3 low voltage power
- Systems instrumentation and control

NOM OD (INCHES): 0.220	AWG SIZE: 22	# OF PAIRS: N/A	# OF CONDUCTORS 4	AVAILABLE JACKET COLORS: ● GREEN
---------------------------	-----------------	--------------------	----------------------	-------------------------------------

# PROJECT STAGING & CUSTOM KITTING

## STREAMLINE YOUR INSTALLS AND SAVE LABOR!



### CUSTOM KITTING

Streamline your installs with a pre-packaged kit, and reduce multiple shipments to a single manageable delivery.



### PROJECT STAGING

Off-site staging program that stages, labels, and palletizes your individual project needs with any product. Ships complete to your site, increasing your efficiencies.

## THE LIBERTY EDGE

TIE OUR PRODUCTS TO OUR SERVICES AND WE ARE UNBEATABLE!



**RUN WITH US**  
www.LibAV.com | 800.530.8998

## NURSE CALL AUDIO 18 AWG 2 CONDUCTOR SHIELDED CABLE

**Nurse Call**  
**NON-PLENUM**



**Features & Benefits:**

- Nurse call audio component
- 18 AWG 7 strand annealed bare copper conductors
- Polyethylene insulation
- Special color code for system designation
- Twisted & shielded
- Flame rated PVC jacket
- NEC CMR, CEC CMG FT4, RoHS compliant
- 1000 foot spools
- Also available in plenum

**TEKTONE-AUDIO**

**Application:**

- OEM system line level audio
- Balanced and unbalanced formats
- Class 2 and Class 3 low voltage power
- Systems instrumentation and control

NOM OD (INCHES): 0.246	AWG SIZE: 18	# OF PAIRS: N/A	# OF CONDUCTORS 2	AVAILABLE JACKET COLORS: ● PART NUMBER COLOR ID: GRY
---------------------------	-----------------	--------------------	----------------------	---

## NURSE CALL DATA 18 AWG 3 CONDUCTOR SHIELDED CABLE

**Nurse Call**  
**NON-PLENUM**

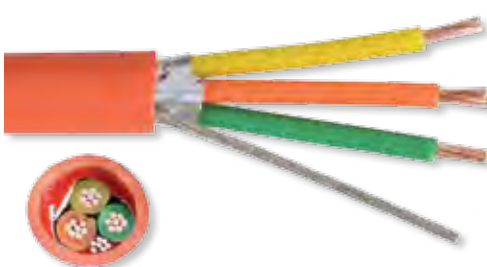

**Features & Benefits:**

- Nurse call audio component
- 18 AWG 7 strand annealed bare copper conductors
- Polyethylene insulation
- Special color code for system designation
- Twisted & shielded
- Flame rated PVC jacket
- NEC CMR, CEC CMG FT4, RoHS compliant
- 1000 foot spools

**TEKTONE-D2**

**Application:**

- OEM system data grade control
- Class 2 and Class 3 low voltage power
- Systems instrumentation and control



**CUSTOMER SERVICE**

We offer technical assistance on all of our products or applications!  
Call us at 800-530-899 or email:  
[orders@LibAV.com](mailto:orders@LibAV.com)

NOM OD (INCHES): 0.240	AWG SIZE: 18	# OF PAIRS: N/A	# OF CONDUCTORS 3	AVAILABLE JACKET COLORS: ● PART NUMBER COLOR ID: ORG
---------------------------	-----------------	--------------------	----------------------	---

## NURSE CALL POWER 18 AWG 3 CONDUCTOR SHIELDED CABLE

**Nurse Call**  
**NON-PLENUM**

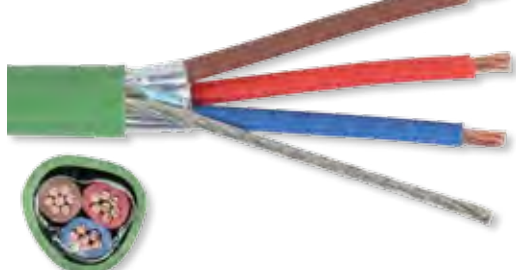

**Features & Benefits:**

- Nurse call audio component
- 18 AWG 7 strand annealed bare copper conductors
- Semi rigid PVC insulation
- Special color code for system designation
- Twisted & shielded
- Flame rated PVC jacket
- NEC CMR, CEC CMG FT4, RoHS compliant
- 1000 foot spools

**TEKTONE-P2**

**Application:**

- OEM system low voltage power delivery
- Class 2 and Class 3 low voltage power
- Systems instrumentation and control

NOM OD (INCHES): 0.175	AWG SIZE: 18	# OF PAIRS: N/A	# OF CONDUCTORS 3	AVAILABLE JACKET COLORS: ● PART NUMBER COLOR ID: GRN
---------------------------	-----------------	--------------------	----------------------	---

## NURSE CALL AUDIO 18 AWG 2 CONDUCTOR SHIELDED PLENUM CABLE

**Nurse Call**  
**PLENUM**



**Features & Benefits:**

- Nurse call audio component
- 18 AWG 7 strand annealed bare copper conductors
- Fluoropolymer insulation
- Special color code for system designation
- Twisted & shielded
- Plenum rated PVC jacket
- NEC CMP, CEC CMP FT6, RoHS compliant
- 1000 foot spools

**TEKTONE-PLN-AUDIO**

**Application:**

- OEM system line level audio
- Balanced and unbalanced formats
- Class 2 and Class 3 low voltage power
- Systems instrumentation and control

NOM OD (INCHES): 0.172	AWG SIZE: 18	# OF PAIRS: N/A	# OF CONDUCTORS 2	AVAILABLE JACKET COLORS: ● PART NUMBER COLOR ID: GRY
---------------------------	-----------------	--------------------	----------------------	---

## NURSECALL NC300 CMP 1000'

**Nurse Call**  
**PLENUM**



**Features & Benefits:**

- TEKTONE Nurse call system bus cable bundle
- 18/2 Low capacitance twisted, shielded audio cable
- 18/3 Low capacitance twisted, shielded data cable
- 18/3 twisted, shielded power cable
- 16/2 twisted, shielded static ground cable
- 4 Components bundled and taped together
- 1000 Foot Spools Made-to-Order (NOT STOCKED)

**TEKTONE-PLN-BUNDLE**

**Application:**

- Single Pull non-plenum umbilical for Nurse Call 300
- Audio, control, power, grounding, and data



**CUSTOM KITTING**  
Streamline your installs with a pre-packaged kit!

NOM OD (INCHES): NA	AWG SIZE: NA	# OF PAIRS: NA	# OF CONDUCTORS NA
------------------------	-----------------	-------------------	-----------------------

## NURSE CALL DATA 18 AWG 3 CONDUCTOR SHIELDED PLENUM CABLE

**Nurse Call**  
**PLENUM**

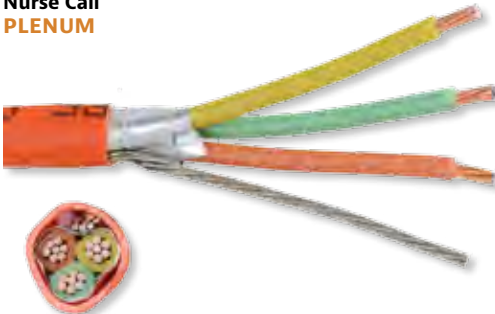

**Features & Benefits:**

- Nurse call audio component
- 18 AWG 7 strand annealed bare copper conductors
- Fluoropolymer insulation
- Special color code for system designation
- Twisted & shielded
- Plenum rated PVC jacket
- NEC CMP, CEC CMP FT6, RoHS compliant
- 1000 foot spools

**TEKTONE-PLN-DATA**

**Application:**

- OEM system data grade control
- Class 2 and Class 3 low voltage power
- Systems instrumentation and control

NOM OD (INCHES): 0.185	AWG SIZE: 18	# OF PAIRS: N/A	# OF CONDUCTORS 3	AVAILABLE JACKET COLORS: ●	PART NUMBER COLOR ID: ORG
---------------------------	-----------------	--------------------	----------------------	----------------------------	---------------------------

## NURSE CALL POWER 18 AWG 3 CONDUCTOR SHIELDED PLENUM CABLE

**Nurse Call**  
**PLENUM**

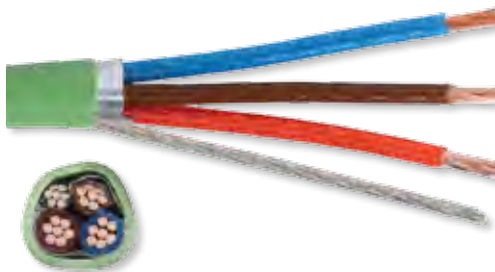

**Features & Benefits:**

- Nurse call audio component
- 18 AWG 7 strand annealed bare copper conductors
- Plenum rated PVC insulation
- Special color code for system designation
- Twisted & shielded
- Plenum rated PVC jacket
- NEC CMP, CEC CMP FT6, RoHS compliant
- 1000 foot spools

**TEKTONE-PLN-POWER**

**Application:**

- OEM system low voltage power delivery
- Class 2 and Class 3 low voltage power
- Systems instrumentation and control

NOM OD (INCHES): 0.166	AWG SIZE: 18	# OF PAIRS: N/A	# OF CONDUCTORS 3	AVAILABLE JACKET COLORS: ●	PART NUMBER COLOR ID: GRN
---------------------------	-----------------	--------------------	----------------------	----------------------------	---------------------------



**LOCKING HDMI**  
When you lose connectivity you lose business!  
See Page: 104

## NURSE CALL COMPOSITE AUDIO, DATA, POWER, AND GROUND CABLE

**Nurse Call**  
**NON-PLENUM**



**Features & Benefits:**

- TEKTONE nurse call system bus cable bundle
- 18/2 low capacitance twisted & shielded audio cable
- 18/3 low capacitance twisted & shielded data cable
- 18/3 twisted, shielded power cable
- 16/2 twisted & shielded static ground cable
- 4 Components bundled and taped together
- 500 Foot spools, made-to-order (not stocked)
- Available in 500 and 1000 foot lengths

**TEKTONE-NC300-500**

**Application:**

- Single pull non-plenum umbilical for Nurse Call 300
- Audio, control, power, grounding and data

NOM OD (INCHES): NA	AWG SIZE: NA	# OF PAIRS: NA	# OF CONDUCTORS NA
------------------------	-----------------	-------------------	-----------------------





## “ MULTI-PURPOSE

Liberty carries a wide range of multi-purpose cables that match up to the big names in the industry. Our product is commercial grade and meets all physical, electrical, and regulatory requirements in both plenum and non-plenum. Whether you need to route Class 2 and Class 3 power, run 70V speakers, wire security sensors or put in a central vacuum system, we have the cable for your installation.



## Multi-Purpose: Non-Plenum Cables

Liberty's definition of non-plenum cable is basically no plenum. We have the following levels grouped under non-plenum so please pay attention to the ratings you need and require:

**RISER:** Signified by the suffix "R" after the article code. These include CL2R, CL3R, CMR, OFNR. The Riser rating indicates the cable has passed the UL1666 flame test. Riser rated cables are backwards compatible to general purpose and limited use cables and Riser ratings are permissible for substitution per the National Electric Code®. Riser rated products can go between floors in commercial building risers as long as there is no environmental air or air handling in those spaces. Riser ratings are authorized for in-wall use.

**GENERAL PURPOSE:** There are two levels of general purpose ratings. Ratings with a suffix of "G" after the article code are certified to the Canadian FT4 flame test. An example is a rating of CMG. If there is no rating suffix at all, such as CL2, CL3, CM, or

OFN then the cable has passed the US UL1685 vertical flame test. General purpose cables are backwards compatible to limited use cables. General purpose ratings are good for single floor use. They cannot be routed between floors except in 1 and 2 family residences.

**LIMITED USE:** Liberty generally does not stock or sell limited use cables. These are signified by a suffix of "X" after the article code. CL2X, CL3X, CMX for example. These are limited to 1 and 2 story, 1 and 2 family residences. They can be used in commercial spaces but only in approved conduit.

**OUTSIDE PLANT:** Also called OSP for short. This is product that has been certified for use in sunlight exposed and direct burial applications outdoors. Liberty OSP products meet all UL requirements for Sunlight Resistance and Direct Burial applications. The products have been tested for UL's crush resistance. At Liberty, we ensure compliance to all code requirements.

### COMMERCIAL GRADE GENERAL PURPOSE 12 AWG 2 CONDUCTOR CABLE

**Commercial  
NON-PLENUM**



**Features & Benefits:**

- 19 strand annealed bare copper conductors
- Semi rigid PVC insulation
- Twisted & unshielded
- Flame rated PVC jacket
- NEC CL3R, CEC CMG FT4 audio only, RoHS compliant
- 1000 foot spools

**12-2C**

**Application:**

- Speaker level audio
- 70 volt speaker cabling
- Class 2 and Class 3 low voltage power
- Instrumentation and control



**TOOLS & ACCESSORIES**

Save time and money!  
See Page: 247

NOM OD (INCHES): 0.280	AWG SIZE: 12	# OF PAIRS: N/A	# OF CONDUCTORS 2	AVAILABLE JACKET COLORS: ●	PART NUMBER COLOR ID: GRY
---------------------------	-----------------	--------------------	----------------------	----------------------------	---------------------------

### COMMERCIAL GRADE GENERAL PURPOSE 12 AWG 4 CONDUCTOR CABLE

**Commercial  
NON-PLENUM**



**Features & Benefits:**

- 19 strand annealed bare copper conductors
- Semi rigid PVC insulation
- Twisted & unshielded
- Flame rated PVC jacket
- NEC CL3R, CEC CMG FT4 audio only, RoHS compliant
- 1000 foot spools

**12-4C**

**Application:**

- Speaker level audio
- 70 volt speaker cabling
- Class 2 and Class 3 low voltage power
- Instrumentation and control

NOM OD (INCHES): 0.326	AWG SIZE: 12	# OF PAIRS: N/A	# OF CONDUCTORS 4	AVAILABLE JACKET COLORS: ●	PART NUMBER COLOR ID: BLK
---------------------------	-----------------	--------------------	----------------------	----------------------------	---------------------------

### COMMERCIAL GRADE GENERAL PURPOSE 14 AWG 2 CONDUCTOR CABLE

**Commercial  
NON-PLENUM**



**Features & Benefits:**

- 19 strand annealed bare copper conductors
- Semi rigid PVC insulation
- Twisted & unshielded
- Flame rated PVC jacket
- NEC CL3R, CEC CMG FT4 audio only, RoHS compliant
- 1000 foot spools

**14-2C**

**Application:**

- Speaker level audio
- 70 volt speaker cabling
- Class 2 and Class 3 low voltage power
- Instrumentation and control

NOM OD (INCHES): 0.228	AWG SIZE: 14	# OF PAIRS: N/A	# OF CONDUCTORS 2	AVAILABLE JACKET COLORS: ●	PART NUMBER COLOR ID: BLK
---------------------------	-----------------	--------------------	----------------------	----------------------------	---------------------------



## COMMERCIAL GRADE GENERAL PURPOSE 16 AWG 2 CONDUCTOR CABLE

**Commercial**  
**NON-PLENUM**



**Features & Benefits:**

- 19 strand annealed bare copper conductors
- Semi rigid PVC insulation
- Twisted & unshielded
- Flame rated PVC jacket
- NEC CMR, CEC CMR FT4, RoHS compliant
- 1000 foot spools

**16-2C**

**Application:**

- Speaker level audio
- 70 volt speaker cabling
- Class 2 and Class 3 low voltage power
- Instrumentation and control

NOM OD (INCHES): 0.172	AWG SIZE: 16	# OF PAIRS: N/A	# OF CONDUCTORS 2	AVAILABLE JACKET COLORS: ●
				PART NUMBER COLOR ID: BLK

## COMMERCIAL GRADE GENERAL PURPOSE 18 AWG 2 CONDUCTOR CABLE

**Commercial**  
**NON-PLENUM**



**Features & Benefits:**

- 7 strand annealed bare copper conductors
- Semi rigid PVC insulation
- Twisted & unshielded
- Flame rated PVC jacket
- NEC CMR, CEC CMR FT4, RoHS compliant
- 1000 foot spools

**18-2C**

**Application:**

- Speaker level audio
- 70 volt speaker cabling
- Class 2 and Class 3 low voltage power
- Instrumentation and control

NOM OD (INCHES): 0.166	AWG SIZE: 18	# OF PAIRS: N/A	# OF CONDUCTORS 2	AVAILABLE JACKET COLORS: ●
				PART NUMBER COLOR ID: GRY

## COMMERCIAL GRADE GENERAL PURPOSE 18 AWG 2 CONDUCTOR SHIELDED CABLE

**Commercial**  
**NON-PLENUM**



**Features & Benefits:**

- 7 strand annealed bare copper conductors
- Semi rigid PVC insulation
- Twisted & shielded
- Flame rated PVC jacket
- NEC CMR, CEC CMR FT4, RoHS compliant
- 1000 foot spools

**18-2C-SH**

**Application:**

- Line level audio
- Security and burgular alarm
- Infrared (IR), RS-232C signaling
- Class 2 and Class 3 low voltage power
- Instrumentation and control

NOM OD (INCHES): 0.169	AWG SIZE: 18	# OF PAIRS: N/A	# OF CONDUCTORS 2	AVAILABLE JACKET COLORS: ●
				PART NUMBER COLOR ID: GRY

## COMMERCIAL GRADE GENERAL PURPOSE 18 AWG 4 CONDUCTOR CABLE

**Commercial**  
**NON-PLENUM**

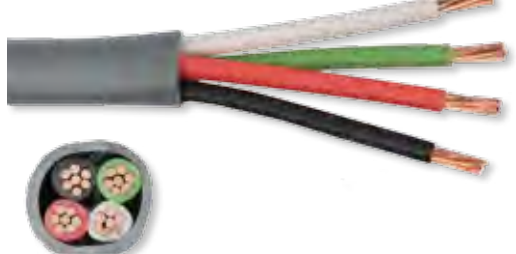

**Features & Benefits:**

- 19 strand annealed bare copper conductors
- Semi rigid PVC insulation
- Twisted & unshielded
- Flame rated PVC jacket
- NEC CMR, CEC CMR FT4, RoHS compliant
- 1000 foot spools

**18-4C**

**Application:**

- Speaker level audio
- 70 volt speaker cabling
- Class 2 and Class 3 low voltage power
- Instrumentation and control



**New Website**  
[www.LibAV.com](http://www.LibAV.com)  
**BETTER, STRONGER, EXPANSIVE!**

NOM OD (INCHES): 0.201	AWG SIZE: 18	# OF PAIRS: N/A	# OF CONDUCTORS 4	AVAILABLE JACKET COLORS: ●
				PART NUMBER COLOR ID: GRY

## COMMERCIAL GRADE GENERAL PURPOSE 18 AWG 4 CONDUCTOR SHIELDED CABLE

**Commercial**  
NON-PLENUM

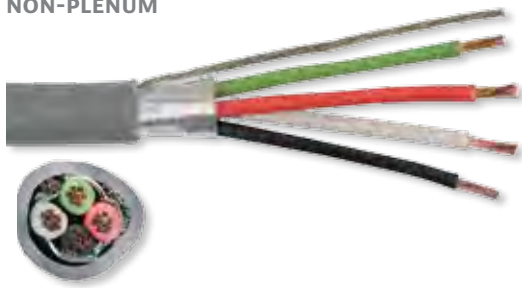

**Features & Benefits:**

- 7 strand annealed bare copper conductors
- Semi rigid PVC insulation
- Twisted & shielded
- Flame rated PVC jacket
- NEC CMR, CEC CMR FT4, RoHS compliant
- 1000 foot spools

**18-4C-SH**

**Application:**

- Line level audio
- Security and burglar alarm
- Infrared (IR), RS-232C signaling
- Class 2 and Class 3 low voltage power
- Instrumentation and control

NOM OD (INCHES): 0.215	AWG SIZE: 18	# OF PAIRS: N/A	# OF CONDUCTORS 4	AVAILABLE JACKET COLORS: ●
				PART NUMBER COLOR ID: GRY

## COMMERCIAL GRADE GENERAL PURPOSE 18 AWG 2 PAIR INDIVIDUALLY SHIELDED CABLE

**Commercial**  
NON-PLENUM

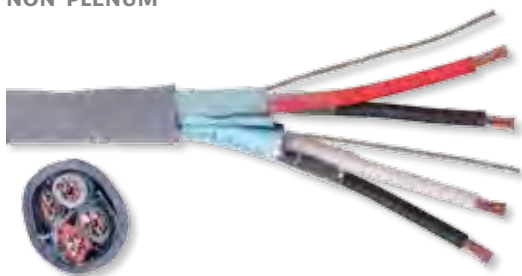

**Features & Benefits:**

- 7 strand annealed bare copper conductors
- Semi rigid PVC insulation
- Each pair twisted, shielded & isolated
- Flame rated PVC jacket
- NEC CMR, CEC CMG FT4, RoHS compliant
- 1000 foot spools

**18-2P-INDSH**

**Application:**

- Line level microphone audio
- Balanced and unbalanced audio formats
- Infrared (IR), RS-232C signaling
- Class 2 and Class 3 low voltage power
- Instrumentation and control



NOM OD (INCHES): 0.270	AWG SIZE: 18	# OF PAIRS: 2	# OF CONDUCTORS 4	AVAILABLE JACKET COLORS: ●
				PART NUMBER COLOR ID: GRY

## COMMERCIAL GRADE GENERAL PURPOSE 20 AWG 2 CONDUCTOR SHIELDED CABLE

**Commercial**  
NON-PLENUM



**Features & Benefits:**

- 7 strand annealed bare copper conductors
- Semi rigid PVC insulation
- Twisted & shielded
- Flame rated PVC jacket
- NEC CMR, CEC CMR FT4, RoHS compliant
- 1000 foot spools

**20-2C-SH**

**Application:**

- Line level audio
- Security and burglar alarm
- Infrared (IR), RS-232C signaling
- Class 2 and Class 3 low voltage power
- Instrumentation and control

NOM OD (INCHES): 0.154	AWG SIZE: 20	# OF PAIRS: N/A	# OF CONDUCTORS 2	AVAILABLE JACKET COLORS: ●
				PART NUMBER COLOR ID: GRY

## COMMERCIAL GRADE GENERAL PURPOSE 22 AWG 2 CONDUCTOR CABLE

**Commercial**  
NON-PLENUM



**Features & Benefits:**

- 7 strand annealed bare copper conductors
- Semi rigid PVC insulation
- Twisted & unshielded
- Flame rated PVC jacket
- NEC CMR, CEC CMR FT4, RoHS compliant
- 1000 foot spools, nested boxes

**22-2C**

**Application:**

- Security contact closure & signaling
- Station wire POTS systems
- Class 2 and Class 3 low voltage power
- Instrumentation and control

NOM OD (INCHES): 0.120	AWG SIZE: 22	# OF PAIRS: N/A	# OF CONDUCTORS 2	AVAILABLE JACKET COLORS: ●
				PART NUMBER COLOR ID: GRY

## COMMERCIAL GRADE GENERAL PURPOSE 22 AWG 6 CONDUCTOR CABLE

**Commercial  
NON-PLENUM**

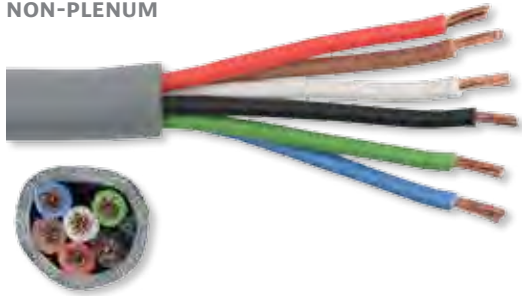

**Features & Benefits:**

- 7 strand annealed bare copper conductors
- Semi rigid PVC insulation
- Twisted & unshielded
- Flame rated PVC jacket
- NEC CMR, CEC CMR FT4, RoHS compliant
- 1000 foot spools or nested boxes

**22-6C**

**Application:**

- Low Voltage Security and Control
- System Instrumentation and control
- DC Power, Class 2 and Class 3 power



NOM OD (INCHES): 0.187	AWG SIZE: 22	# OF PAIRS: N/A	# OF CONDUCTORS 6	AVAILABLE JACKET COLORS: ● PART NUMBER COLOR ID: GRY
---------------------------	-----------------	--------------------	----------------------	---

## COMMERCIAL GRADE GENERAL PURPOSE 22 AWG 2 CONDUCTOR SHIELDED CABLE

**Commercial  
NON-PLENUM**



**Features & Benefits:**

- 7 strand annealed bare copper conductors
- Semi rigid PVC insulation
- Twisted & shielded
- Flame rated PVC jacket
- NEC CMR, CEC CMR FT4, RoHS compliant
- 1000 foot spools

**22-2C-SH**

**Application:**

- Line level & microphone audio
- Balanced and unbalanced audio formats
- Infrared (IR), RS-232C signaling
- Class 2 and Class 3 low voltage power
- Instrumentation and control

NOM OD (INCHES): 0.130	AWG SIZE: 22	# OF PAIRS: N/A	# OF CONDUCTORS 2	AVAILABLE JACKET COLORS: ● PART NUMBER COLOR ID: GRY
---------------------------	-----------------	--------------------	----------------------	---

## COMMERCIAL GRADE GENERAL PURPOSE 22 AWG 4 CONDUCTOR CABLE

**Commercial  
NON-PLENUM**

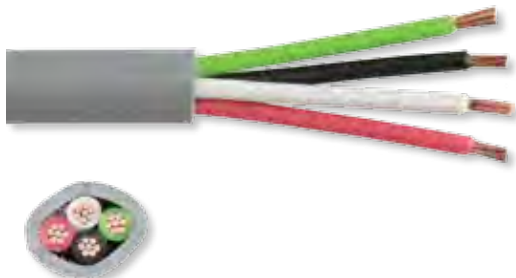

**Features & Benefits:**

- 7-strand annealed bare copper conductors
- Semi-Rigid PVC insulation
- Twisted, unshielded
- Flame rated PVC jacket
- NEC CMR, CEC CMR FT4, RoHS compliant
- 1000 foot spools, nested boxes

**22-4C**

**Application:**

- Security contact closure, signaling
- Station wire POTS systems
- Class 2 and Class 3 low voltage power
- Instrumentation and control

NOM OD (INCHES): 0.030"	AWG SIZE: 22	# OF PAIRS: N/A	# OF CONDUCTORS 4	AVAILABLE JACKET COLORS: ● PART NUMBER COLOR ID: GRY
----------------------------	-----------------	--------------------	----------------------	---

## COMMERCIAL GRADE GENERAL PURPOSE 22 AWG 4 CONDUCTOR SHIELDED CABLE

**Commercial  
NON-PLENUM**



**Features & Benefits:**

- 7 strand annealed bare copper conductors
- Semi rigid PVC insulation
- Twisted & shielded
- Flame rated PVC jacket
- NEC CMR, CEC CMR FT4, RoHS compliant
- 1000 foot spools

**22-4C-SH**

**Application:**

- Line level audio
- Security and burgular alarm
- Infrared (IR), RS-232C signaling
- Class 2 and Class 3 low voltage power
- Instrumentation and control

NOM OD (INCHES): 0.162	AWG SIZE: 22	# OF PAIRS: N/A	# OF CONDUCTORS 4	AVAILABLE JACKET COLORS: ● PART NUMBER COLOR ID: GRY
---------------------------	-----------------	--------------------	----------------------	---

## COMMERCIAL GRADE GENERAL PURPOSE 22 AWG 6 CONDUCTOR SHIELDED CABLE

**Commercial**  
**NON-PLENUM**

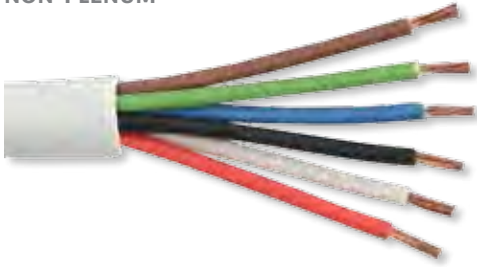

**Features & Benefits:**

- 7 strand annealed bare copper conductors
- Semi rigid PVC insulation
- Twisted & shielded
- Flame rated PVC jacket
- NEC CMR, CEC CMR FT4, RoHS compliant
- 1000 foot spools

**22-6C-SH**

**Application:**

- Line level audio
- Security and burglar alarm
- Infrared (IR), RS-232C signaling
- Class 2 and Class 3 low voltage power
- Instrumentation and control

NOM OD (INCHES): 0.178	AWG SIZE: 22	# OF PAIRS: N/A	# OF CONDUCTORS 6	AVAILABLE JACKET COLORS: ●	PART NUMBER COLOR ID: GRY
---------------------------	-----------------	--------------------	----------------------	----------------------------	---------------------------

## COMMERCIAL GRADE GENERAL PURPOSE 22 AWG 8 CONDUCTOR SHIELDED CABLE

**Commercial**  
**NON-PLENUM**



**Features & Benefits:**

- 7 strand annealed bare copper conductors
- Semi rigid PVC insulation
- Twisted & shielded
- Flame rated PVC jacket
- NEC CMR, CEC CMR FT4, RoHS compliant
- 1000 foot spools

**22-8C-SH**

**Application:**

- Line level audio
- Security and burglar alarm
- Infrared (IR), RS-232C signaling
- Class 2 and Class 3 low voltage power
- Instrumentation and control



**New Website**  
[www.LibAV.com](http://www.LibAV.com)  
**BETTER, STRONGER,  
EXPANSIVE!**

NOM OD (INCHES): 0.167	AWG SIZE: 22	# OF PAIRS: N/A	# OF CONDUCTORS 8	AVAILABLE JACKET COLORS: ●	PART NUMBER COLOR ID: GRY
---------------------------	-----------------	--------------------	----------------------	----------------------------	---------------------------

## COMMERCIAL GRADE GENERAL PURPOSE 22 AWG 2 PAIR INDIVIDUALLY SHIELDED CABLE

**Commercial**  
**NON-PLENUM**



**Features & Benefits:**

- 7 strand annealed bare copper conductors
- Polypropylene dielectric insulation
- Each pair twisted, shielded & isolated
- Flame rated PVC jacket
- NEC CM, CEC CMG FT4, RoHS compliant
- 1000 foot nested pull boxes

**22-2P-INDSH**

**Application:**

- Line level & microphone audio
- Balanced and unbalanced audio formats
- Infrared (IR), RS-232C signaling
- Class 2 and Class 3 low voltage power
- Instrumentation and control

NOM OD (INCHES): 0.175	AWG SIZE: 22	# OF PAIRS: 2	# OF CONDUCTORS 4	AVAILABLE JACKET COLORS: ●	PART NUMBER COLOR ID: GRY
---------------------------	-----------------	------------------	----------------------	----------------------------	---------------------------

## Multi-Purpose: Plenum Cables

Plenum rated products have passed the highest flame test, NFPA-262. These products have a suffix of "P" after the article code. Some examples of the ratings you will find on the jacket are CL2P, CL3P, CMP, and OFNP. Plenum rated products can go between floors in commercial building where environmental air or air handling requirements exist for those spaces.

Other locations that will commonly call out Plenum requirements are the airspaces between drop ceilings and the actual construction. Plenum ratings are also authorized for in-wall use and plenum is backwards compatible for Riser, General Purpose, and Limited Use. Plenum rated product should never be used as OSP cable.



## COMMERCIAL GRADE GENERAL PURPOSE 12 AWG 2 CONDUCTOR PLENUM CABLE

**Commercial PLENUM**



**Features & Benefits:**

- 19 strand annealed bare copper conductors
- Plenum rated PVC insulation
- Twisted & unshielded
- Plenum rated PVC jacket
- NEC CL3P, CEC CMP FT6 audio only, RoHS compliant
- 1000 foot spools

**12-2C-P**

**Application:**

- Speaker level audio
- 70 volt speaker cabling
- Class 2 and Class 3 low voltage power
- Instrumentation and control

NOM OD (INCHES): 0.256	AWG SIZE: 12	# OF PAIRS: N/A	# OF CONDUCTORS 2	AVAILABLE JACKET COLORS: ● ○ PART NUMBER COLOR ID: BLK WHT
---------------------------	-----------------	--------------------	----------------------	---

## COMMERCIAL GRADE GENERAL PURPOSE 12 AWG 3 CONDUCTOR PLENUM CABLE

**Commercial PLENUM**

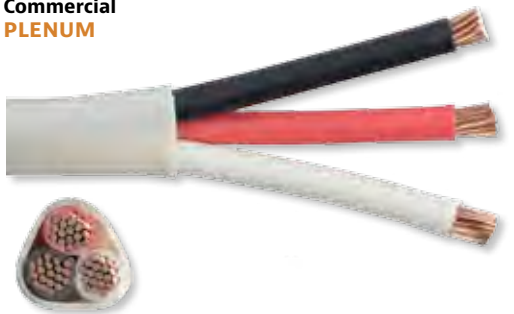

**Features & Benefits:**

- Stranded annealed bare copper conductors
- Twisted & unshielded
- Plenum rated PVC Alloy insulation
- NEC CL3P, CEC CMP FT6, RoHS Compliant
- 1000 Foot Spools

**12-3C-P**

**Application:**

- Speaker level audio distribution
- 70 volt Speaker systems
- DC power Class 2 and Class 3 power, system control

NOM OD (INCHES): 0.263	AWG SIZE: 12	# OF PAIRS: N/A	# OF CONDUCTORS 3	AVAILABLE JACKET COLORS: ○ PART NUMBER COLOR ID: WHT
---------------------------	-----------------	--------------------	----------------------	---

## COMMERCIAL GRADE GENERAL PURPOSE 14 AWG 2 CONDUCTOR PLENUM CABLE

**Commercial PLENUM**



**Features & Benefits:**

- 19 strand annealed bare copper conductors
- Plenum rated PVC insulation
- Twisted & unshielded
- Plenum rated PVC insulation
- NEC CL3P, CEC CMP FT6 audio only, RoHS compliant
- 1000 foot spools

**14-2C-P**

**Application:**

- Speaker level audio
- 70 volt speaker cabling
- Class 2 and Class 3 low voltage power
- Instrumentation and control

NOM OD (INCHES): 0.210	AWG SIZE: 14	# OF PAIRS: N/A	# OF CONDUCTORS 2	AVAILABLE JACKET COLORS: ● ○ PART NUMBER COLOR ID: BLK WHT
---------------------------	-----------------	--------------------	----------------------	---

## COMMERCIAL GRADE GENERAL PURPOSE 14 AWG 2 CONDUCTOR PLENUM SHIELDED CABLE

**Commercial PLENUM**



**Features & Benefits:**

- 19 strand annealed bare copper conductors
- Plenum rated PVC insulation
- Twisted & shielded
- Plenum rated PVC jacket
- NEC CL3P, CEC CMP FT6 audio only, RoHS compliant
- 1000 foot spools

**14-2C-PSH**

**Application:**

- Speaker level audio
- 70 volt speaker cabling
- Class 2 and Class 3 low voltage power
- Instrumentation and control



**PREMIUM CONNECTORS**  
Options for any type of professional installation  
[See Page: 117](#)

NOM OD (INCHES): 0.223	AWG SIZE: 14	# OF PAIRS: N/A	# OF CONDUCTORS 2	AVAILABLE JACKET COLORS: ○ PART NUMBER COLOR ID: WHT
---------------------------	-----------------	--------------------	----------------------	---

## COMMERCIAL GRADE GENERAL PURPOSE 14 AWG 4 CONDUCTOR PLENUM CABLE

**Commercial PLENUM**



**Features & Benefits:**

- 19 strand annealed bare copper conductors
- Plenum rated PVC insulation
- Twisted & unshielded
- Plenum rated PVC jacket
- NEC CL3P, CEC CMP FT6 audio only, RoHS compliant
- 1000 foot spools

**14-4C-P**

**Application:**

- Speaker level audio
- 70 volt speaker cabling
- Class 2 and Class 3 low voltage power
- Instrumentation and control

NOM OD (INCHES): 0.247	AWG SIZE: 14	# OF PAIRS: N/A	# OF CONDUCTORS 4	AVAILABLE JACKET COLORS: <input type="radio"/>
				PART NUMBER COLOR ID: WHT

## COMMERCIAL GRADE GENERAL PURPOSE 16 AWG 2 CONDUCTOR PLENUM CABLE

**Commercial PLENUM**



**Features & Benefits:**

- 19 strand annealed bare copper conductors
- Plenum rated PVC insulation
- Twisted & unshielded
- Plenum rated PVC jacket
- NEC CMP, CEC CMP FT6, RoHS compliant
- 1000 foot spools

**16-2C-P**

**Application:**

- Speaker level audio
- 70 volt speaker cabling
- Class 2 and Class 3 low voltage power
- Instrumentation and control



**LOCKING HDMI**  
When you lose connectivity you lose business!  
[See Page: 104](#)

NOM OD (INCHES): 0.190	AWG SIZE: 16	# OF PAIRS: N/A	# OF CONDUCTORS 2	AVAILABLE JACKET COLORS: <input checked="" type="radio"/> <input type="radio"/>
				PART NUMBER COLOR ID: BLK WHT

## COMMERCIAL GRADE GENERAL PURPOSE 16 AWG 2 CONDUCTOR PLENUM SHIELDED CABLE

**Commercial PLENUM**



**Features & Benefits:**

- 19 strand annealed bare copper conductors
- Plenum rated PVC insulation
- Twisted & shielded
- Plenum rated PVC jacket
- NEC CMP, CEC CMP FT6, RoHS compliant
- 1000 foot spools

**16-2C-PSH**

**Application:**

- Speaker level audio
- 70 volt speaker cabling
- Class 2 and Class 3 low voltage power
- Instrumentation and control

NOM OD (INCHES): 0.178	AWG SIZE: 16	# OF PAIRS: N/A	# OF CONDUCTORS 2	AVAILABLE JACKET COLORS: <input type="radio"/>
				PART NUMBER COLOR ID: WHT

## COMMERCIAL GRADE GENERAL PURPOSE 16 AWG 4 CONDUCTOR PLENUM CABLE

**Commercial PLENUM**



**Features & Benefits:**

- 19 strand annealed bare copper conductors
- Plenum rated PVC insulation
- Twisted & unshielded
- Plenum rated PVC jacket
- NEC CMP, CEC CMP FT6, RoHS compliant
- 1000 foot spools

**16-4C-P**

**Application:**

- Speaker level audio
- 70 volt speaker cabling
- Class 2 and Class 3 low voltage power
- Instrumentation and control

NOM OD (INCHES): 0.214	AWG SIZE: 16	# OF PAIRS: N/A	# OF CONDUCTORS 4	AVAILABLE JACKET COLORS: <input type="radio"/>
				PART NUMBER COLOR ID: WHT

## COMMERCIAL GRADE GENERAL PURPOSE 18 AWG 2 CONDUCTOR PLENUM CABLE

**Commercial**  
**PLENUM**



**Features & Benefits:**

- 7 strand annealed bare copper conductors
- Plenum rated PVC insulation
- Twisted & unshielded
- Plenum rated PVC jacket
- NEC CMP, CEC CMP FT6, RoHS compliant
- 1000 foot spools

**18-2C-P**

**Application:**

- Speaker level audio
- 70 volt speaker cabling
- Class 2 and Class 3 low voltage power
- Instrumentation and control

NOM OD (INCHES): 0.154	AWG SIZE: 18	# OF PAIRS: N/A	# OF CONDUCTORS 2	AVAILABLE JACKET COLORS: ● ○ PART NUMBER COLOR ID: BLK WHT
---------------------------	-----------------	--------------------	----------------------	---

## COMMERCIAL GRADE GENERAL PURPOSE 18 AWG 2 CONDUCTOR PLENUM SHIELDED CABLE

**Commercial**  
**PLENUM**



**Features & Benefits:**

- 7 strand annealed bare copper conductors
- Plenum rated PVC insulation
- Twisted & shielded
- Plenum rated PVC jacket
- NEC CMP, CEC CMP FT6, RoHS compliant
- 1000 foot spools

**18-2C-PSH**

**Application:**

- Speaker level audio
- 70 volt speaker cabling
- Class 2 and Class 3 low voltage power
- Instrumentation and control

NOM OD (INCHES): 0.154	AWG SIZE: 18	# OF PAIRS: N/A	# OF CONDUCTORS 2	AVAILABLE JACKET COLORS: ● ○ PART NUMBER COLOR ID: BLK WHT
---------------------------	-----------------	--------------------	----------------------	---

## COMMERCIAL GRADE GENERAL PURPOSE 18 AWG 3 CONDUCTOR PLENUM CABLE

**Commercial**  
**PLENUM**



**Features & Benefits:**

- 7 strand annealed bare copper conductors
- Plenum rated PVC insulation
- Twisted & unshielded
- Plenum rated PVC jacket
- NEC CMP, CEC CMP FT6, RoHS compliant
- 1000 foot spools

**18-3C-P**

**Application:**

- Speaker level audio
- 70 volt speaker cabling
- Class 2 and Class 3 low voltage power
- Instrumentation and control



**CUSTOMER SERVICE**

We offer technical assistance on all of our products or applications! Call us at 800-530-899 or email: [orders@LibAV.com](mailto:orders@LibAV.com)

NOM OD (INCHES): 0.164	AWG SIZE: 18	# OF PAIRS: N/A	# OF CONDUCTORS 3	AVAILABLE JACKET COLORS: ○ PART NUMBER COLOR ID: WHT
---------------------------	-----------------	--------------------	----------------------	---

## COMMERCIAL GRADE GENERAL PURPOSE 18 AWG 3 CONDUCTOR PLENUM SHIELDED CABLE

**Commercial**  
**PLENUM**

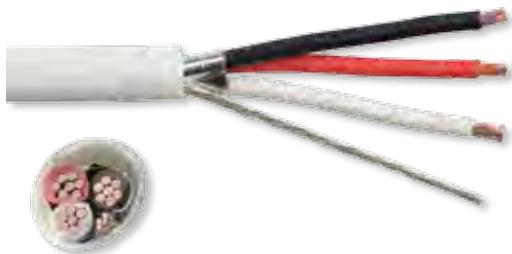

**Features & Benefits:**

- 7 strand annealed bare copper conductors
- Plenum rated PVC insulation
- Twisted & shielded
- Plenum rated PVC jacket
- NEC CMP, CEC CMP FT6, RoHS compliant
- 1000 foot spools

**18-3C-PSH**

**Application:**

- Speaker level audio
- 70 volt speaker cabling
- Class 2 and Class 3 low voltage power
- Instrumentation and control

NOM OD (INCHES): 0.166	AWG SIZE: 18	# OF PAIRS: N/A	# OF CONDUCTORS 3	AVAILABLE JACKET COLORS: ○ PART NUMBER COLOR ID: WHT
---------------------------	-----------------	--------------------	----------------------	---

## COMMERCIAL GRADE GENERAL PURPOSE 18 AWG 4 CONDUCTOR PLENUM CABLE

**Commercial PLENUM**



**Features & Benefits:**

- 7 strand annealed bare copper conductors
- Plenum rated PVC insulation
- Twisted & unshielded
- Plenum rated PVC jacket
- NEC CMP, CEC CMP FT6, RoHS compliant
- 1000 foot spools

**18-4C-P**

**Application:**

- Speaker level audio
- 70 volt speaker cabling
- Class 2 and Class 3 low voltage power
- Instrumentation and control

NOM OD (INCHES): 0.180	AWG SIZE: 18	# OF PAIRS: N/A	# OF CONDUCTORS 4	AVAILABLE JACKET COLORS: <input type="radio"/>	PART NUMBER COLOR ID: WHT
---------------------------	-----------------	--------------------	----------------------	--	---------------------------

## COMMERCIAL GRADE GENERAL PURPOSE 18 AWG 4 CONDUCTOR PLENUM SHIELDED CABLE

**Commercial PLENUM**

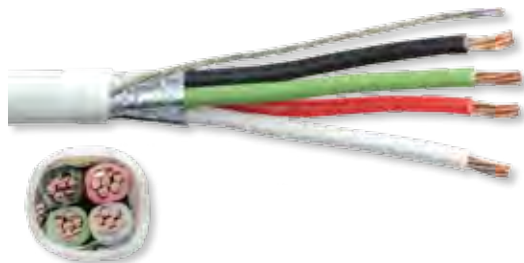

**Features & Benefits:**

- 7 strand annealed bare copper conductors
- Plenum rated PVC insulation
- Twisted & shielded
- Plenum rated PVC jacket
- NEC CMP, CEC CMP FT6, RoHS compliant
- 1000 foot spools

**18-4C-PSH**

**Application:**

- Speaker level audio
- 70 volt speaker cabling
- Class 2 and Class 3 low voltage power
- Instrumentation and control



NOM OD (INCHES): 0.180	AWG SIZE: 18	# OF PAIRS: N/A	# OF CONDUCTORS 4	AVAILABLE JACKET COLORS: <input type="radio"/>	PART NUMBER COLOR ID: WHT
---------------------------	-----------------	--------------------	----------------------	--	---------------------------

## COMMERCIAL GRADE GENERAL PURPOSE 20 AWG 2 CONDUCTOR PLENUM SHIELDED CABLE

**Commercial PLENUM**



**Features & Benefits:**

- 7 strand annealed bare copper conductors
- Plenum rated PVC insulation
- Twisted & shielded
- Plenum rated PVC jacket
- NEC CMP, CEC CMP FT6, RoHS compliant
- 1000 foot spools

**20-2C-PSH**

**Application:**

- Speaker level audio
- 70 volt speaker cabling
- Class 2 and Class 3 low voltage power
- Instrumentation and control

NOM OD (INCHES): 0.130	AWG SIZE: 20	# OF PAIRS: N/A	# OF CONDUCTORS 2	AVAILABLE JACKET COLORS: <input type="radio"/>	PART NUMBER COLOR ID: WHT
---------------------------	-----------------	--------------------	----------------------	--	---------------------------

## COMMERCIAL GRADE GENERAL PURPOSE 20 AWG 3 CONDUCTOR PLENUM SHIELDED CABLE

**Commercial PLENUM**

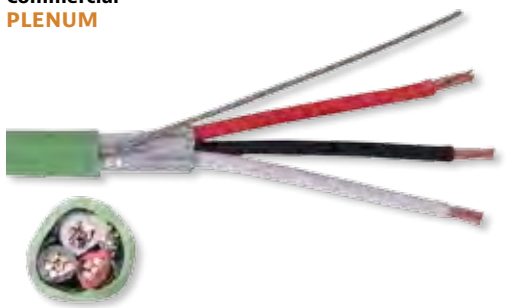

**Features & Benefits:**

- 7 strand annealed bare copper conductors
- Plenum rated PVC insulation
- Twisted & shielded
- Plenum rated PVC jacket
- NEC CMP, CEC CMP FT6, RoHS compliant
- 1000 foot spools

**20-3C-PSH**

**Application:**

- Speaker level audio
- 70 volt speaker cabling
- Class 2 and Class 3 low voltage power
- Instrumentation and control

NOM OD (INCHES): 0.139	AWG SIZE: 20	# OF PAIRS: N/A	# OF CONDUCTORS 3	AVAILABLE JACKET COLORS: <input type="radio"/>	PART NUMBER COLOR ID: WHT
---------------------------	-----------------	--------------------	----------------------	--	---------------------------



## COMMERCIAL GRADE GENERAL PURPOSE 22 AWG 2 CONDUCTOR PLENUM CABLE

**Commercial**  
**PLENUM**



**Features & Benefits:**

- 7 strand annealed bare copper conductors
- Plenum rated PVC insulation
- Twisted & unshielded
- Plenum rated PVC jacket
- NEC CMP, CEC CMP FT6, RoHS compliant
- 1000 foot spools

**22-2C-P**

**Application:**

- Line level audio
- Security and burglar alarm
- Infrared (IR), RS-232C signaling
- Class 2 and Class 3 low voltage power
- Instrumentation and control

NOM OD (INCHES): 0.118	AWG SIZE: 22	# OF PAIRS: N/A	# OF CONDUCTORS 2	AVAILABLE JACKET COLORS: <input type="radio"/>
				PART NUMBER COLOR ID: WHT

## COMMERCIAL GRADE GENERAL PURPOSE 22 AWG 2 CONDUCTOR PLENUM SHIELDED CABLE

**Commercial**  
**PLENUM**



**Features & Benefits:**

- 7 strand annealed bare copper conductors
- Plenum rated PVC alloy insulation
- Twisted & shielded
- Plenum rated PVC jacket
- NEC CMP, CEC CMP FT6, RoHS compliant
- 1000 foot spools

**22-2C-PSH**

**Application:**

- Line level, microphone audio
- Balanced and unbalanced audio formats
- Infrared (IR), RS-232C signaling
- Class 2 and Class 3 low voltage power
- Instrumentation and control

NOM OD (INCHES): 0.116	AWG SIZE: 22	# OF PAIRS: N/A	# OF CONDUCTORS 2	AVAILABLE JACKET COLORS: <input checked="" type="radio"/> <input type="radio"/>
				PART NUMBER COLOR ID: BLK WHT

## COMMERCIAL GRADE GENERAL PURPOSE 22 AWG 2 PAIR PLENUM INDIVIDUALLY SHIELDED CABLE

**Commercial**  
**PLENUM**



**Features & Benefits:**

- 7 strand annealed bare copper conductors
- Plenum rated PVC alloy insulation
- Each pair twisted, shielded & isolated
- Plenum rated PVC jacket
- NEC CMP, CEC CMP FT6, RoHS compliant
- 1000 foot spools

**22-2P-PINDSH**

**Application:**

- Line level, microphone audio
- Balanced and unbalanced audio formats
- Infrared (IR), RS-232C signaling
- Class 2 and Class 3 low voltage power
- Instrumentation and control



**CUSTOM KITTING**  
Streamline your installs with a pre-packaged kit!

NOM OD (INCHES): 0.160	AWG SIZE: 22	# OF PAIRS: 2	# OF CONDUCTORS 4	AVAILABLE JACKET COLORS: <input checked="" type="radio"/> <input type="radio"/>
				PART NUMBER COLOR ID: BLK WHT

## COMMERCIAL GRADE GENERAL PURPOSE 22 AWG 3 PAIR PLENUM INDIVIDUALLY SHIELDED CABLE

**Commercial**  
**PLENUM**

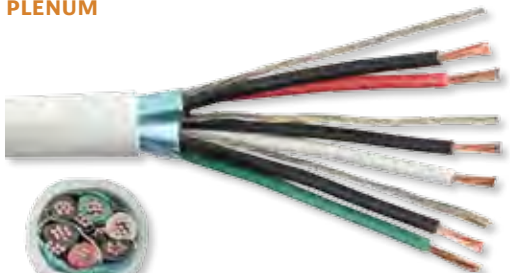

**Features & Benefits:**

- Stranded annealed bare copper conductors
- Plenum rated PVC alloy insulation
- Twisted & individually isolated shielded pairs
- Plenum rated PVC jacket
- NEC CMP, CEC CMP FT6, RoHS compliant
- 1000 foot spools

**22-3P-PINDSH**

**Application:**

- Line level, microphone audio runs under 100 feet
- Balanced and unbalanced audio formats
- Infrared (IR), RS-232C signaling
- Instrumentation and control

NOM OD (INCHES): 0.198	AWG SIZE: 22	# OF PAIRS: 3	# OF CONDUCTORS 6	AVAILABLE JACKET COLORS: <input type="radio"/>
				PART NUMBER COLOR ID: WHT

## COMMERCIAL GRADE GENERAL PURPOSE 22 AWG 4 CONDUCTOR PLENUM CABLE

Commercial  
PLENUM



**Features & Benefits:**

- 7 strand annealed bare copper conductors
- Plenum rated PVC insulation
- Twisted & unshielded
- Plenum rated PVC jacket
- NEC CMP, CEC CMP FT6, RoHS compliant
- 1000 foot spools

**22-4C-P**

**Application:**

- Line level audio
- Security and burglar alarm
- Infrared (IR), RS-232C signaling
- Class 2 and Class 3 low voltage power
- Instrumentation and control

NOM OD (INCHES): 0.144	AWG SIZE: 22	# OF PAIRS: N/A	# OF CONDUCTORS 4	AVAILABLE JACKET COLORS: <input type="radio"/>
				PART NUMBER COLOR ID: WHT

## COMMERCIAL GRADE GENERAL PURPOSE 22 AWG 4 CONDUCTOR PLENUM SHIELDED CABLE

Commercial  
PLENUM

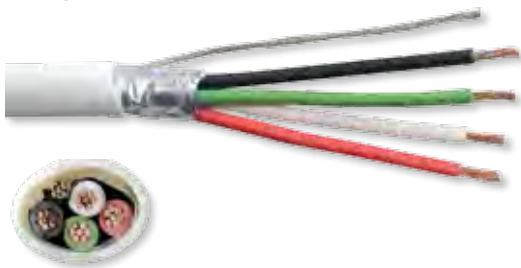

**Features & Benefits:**

- 7 strand annealed bare copper conductors
- Plenum rated PVC alloy insulation
- Twisted & shielded
- Plenum rated PVC jacket
- NEC CMP, CEC CMP FT6, RoHS compliant
- 1000 foot spools

**22-4C-PSH**

**Application:**

- Line level audio
- Security and burglar alarm
- Infrared (IR), RS-232C signaling
- Class 2 and Class 3 low voltage power
- Instrumentation and control

NOM OD (INCHES): 0.135	AWG SIZE: 22	# OF PAIRS: N/A	# OF CONDUCTORS 4	AVAILABLE JACKET COLORS: <input checked="" type="radio"/> <input type="radio"/>
				PART NUMBER COLOR ID: BLK WHT

## COMMERCIAL GRADE GENERAL PURPOSE 22 AWG 4 PAIR PLENUM INDIVIDUALLY SHIELDED CABLE

Commercial  
PLENUM

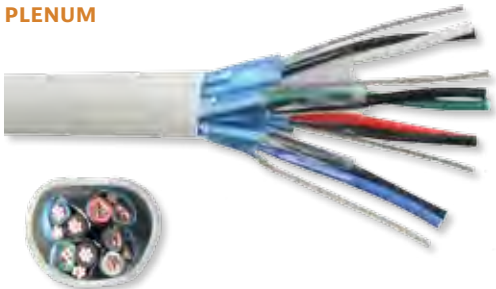

**Features & Benefits:**

- Stranded annealed bare copper conductors
- Plenum rated PVC alloy insulation
- Twisted & individually isolated shielded pairs
- Plenum rated PVC jacket
- NEC CMP, CEC CMP FT6, RoHS compliant
- 1000 foot spools

**22-4P-PINDSH**

**Application:**

- Line level, microphone audio runs under 100 feet
- Balanced and unbalanced audio formats
- Infrared (IR), RS-232C signaling
- Instrumentation and control



NOM OD (INCHES): 0.215	AWG SIZE: 22	# OF PAIRS: 4	# OF CONDUCTORS 8	AVAILABLE JACKET COLORS: <input type="radio"/>
				PART NUMBER COLOR ID: WHT

## COMMERCIAL GRADE GENERAL PURPOSE 22 AWG 6 CONDUCTOR PLENUM SHIELDED CABLE

**Commercial PLENUM**



**Features & Benefits:**

- 7 strand annealed bare copper conductors
- Plenum rated PVC alloy insulation
- Twisted & shielded
- Plenum rated PVC jacket
- NEC CMP, CEC CMP FT6, RoHS compliant
- 1000 foot spools

**22-6C-PSH**

**Application:**

- Line level audio
- Security and burglar alarm
- Infrared (IR), RS-232C signaling
- Class 2 and Class 3 low voltage power
- Instrumentation and Control

NOM OD (INCHES): 0.162	AWG SIZE: 22	# OF PAIRS: N/A	# OF CONDUCTORS 6	AVAILABLE JACKET COLORS: <input type="radio"/>
				PART NUMBER COLOR ID: WHT

## COMMERCIAL GRADE GENERAL PURPOSE 22 AWG 8 CONDUCTOR PLENUM SHIELDED CABLE

**Commercial PLENUM**



**Features & Benefits:**

- 7 strand annealed bare copper conductors
- Plenum rated PVC alloy insulation
- Twisted & shielded
- Plenum rated PVC jacket
- NEC CMP, CEC CMP FT6, RoHS compliant
- 1000 foot spools

**22-8C-PSH**

**Application:**

- Line level audio
- Security and burglar alarm
- Infrared (IR), RS-232C signaling
- Class 2 and Class 3 low voltage power
- Instrumentation and control

NOM OD (INCHES): 0.183	AWG SIZE: 22	# OF PAIRS: N/A	# OF CONDUCTORS 8	AVAILABLE JACKET COLORS: <input type="radio"/> <input checked="" type="radio"/>
				PART NUMBER COLOR ID: WHT BLU



**COOL SPOOL SYSTEM®**  
Our exclusive reel box and hand truck means tangle-free pulls and total control  
[See Page: 253](#)

## COMMERCIAL GRADE GENERAL PURPOSE 22 AWG 10 CONDUCTOR PLENUM CABLE

**Commercial PLENUM**

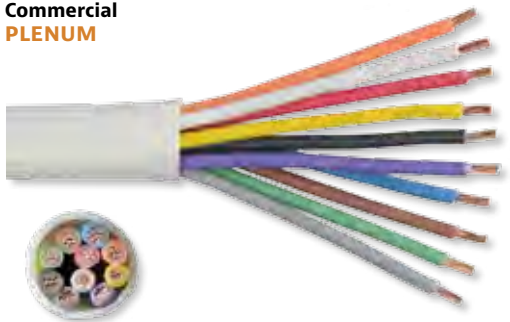

**Features & Benefits:**

- 7 strand annealed bare copper conductors
- Plenum rated PVC insulation
- Twisted & unshielded
- Plenum rated PVC jacket
- NEC CMP, CEC CMP FT6, RoHS compliant
- 1000 foot spools

**22-10C-P**

**Application:**

- Line level audio
- Security and burglar alarm
- Infrared (IR), RS-232C signaling
- Class 2 and Class 3 low voltage power
- Instrumentation and control

NOM OD (INCHES): 0.192	AWG SIZE: 22	# OF PAIRS: N/A	# OF CONDUCTORS 10	AVAILABLE JACKET COLORS: <input type="radio"/>
				PART NUMBER COLOR ID: WHT

**THE LIBERTY LEVERAGE OUR SERVICES AS AN EXTENSION OF YOUR WORKFORCE!**  
**EDGE** Consolidate purchases, save time, labor & improve your profitability by putting the expansive Liberty Edge services to work for you! **CALL YOUR REP TODAY FOR DETAILS! 800.530.8998**



## RF/CATV/DBS VIDEO

“ Liberty offers dual and quad shield RG6 and RG11 sized cables for the CATV and Satellite market. Our outdoor bare copper versions are wildly popular for those remote satellite runs and DC power required CATV applications. Low loss high quality cable to get the best performance for your spend and check out our matching C-Tec2 connectors matched to the cables. ”



### RF/CATV/DBS Video: Non-Plenum Cables

Liberty's definition of non-plenum cable is basically no plenum. We have the following levels grouped under non-plenum so please pay attention to the ratings you need and require:

**RISER:** Signified by the suffix "R" after the article code. These include CL2R, CL3R, CMR, OFNR. The Riser rating indicates the cable has passed the UL1666 flame test. Riser rated cables are backwards compatible to general purpose and limited use cables and Riser ratings are permissible for substitution per the National Electric Code®. Riser rated products can go between floors in commercial building risers as long as there is no environmental air or air handling in those spaces. Riser ratings are authorized for in-wall use.

**GENERAL PURPOSE:** There are two levels of general purpose ratings. Ratings with a suffix of "G" after the article code are certified to the Canadian FT4 flame test. An example is a rating of CMG. If there is no rating suffix at all, such as CL2, CL3, CM, or

OFN then the cable has passed the US UL1685 vertical flame test. General purpose cables are backwards compatible to limited use cables. General purpose ratings are good for single floor use. They cannot be routed between floors except in 1 and 2 family residences.

**LIMITED USE:** Liberty generally does not stock or sell limited use cables. These are signified by a suffix of "X" after the article code. CL2X, CL3X, CMX for example. These are limited to 1 and 2 story, 1 and 2 family residences. They can be used in commercial spaces but only in approved conduit.

**OUTSIDE PLANT:** Also called OSP for short. This is product that has been certified for use in sunlight exposed and direct burial applications outdoors. Liberty OSP products meet all UL requirements for Sunlight Resistance and Direct Burial applications. The products have been tested for UL's crush resistance. At Liberty, we ensure compliance to all code requirements.

#### RG6 CCS QUAD SHIELDED RF VIDEO 3.0 GHZ OUTSIDE PLANT CABLE

**Residential**  
NON-PLENUM, DIRECT BURIAL



##### Features & Benefits:

- 18 AWG solid copper clad steel conductor
- Gas injected cellular polyethylene dielectric
- quad shield foil + 60% and foil + 40% aluminum
- Floodant compound
- Polyethylene jacket
- 3.0 GHz sweep for all CATV through DBS needs
- Direct burial, sunlight resistant, RoHS compliant
- 1000 foot spools

##### RG6-QUAD-DB

##### Application:

- CATV/MATV and direct broadcast satellite (DBS)
- Cable modem, Non-DC pass circuits
- High frequency RF modulated signals

NOM OD (INCHES): 0.300	AWG SIZE: 18	# OF PAIRS: N/A	# OF CONDUCTORS 1	AVAILABLE JACKET COLORS: ● PART NUMBER COLOR ID: BLK
---------------------------	-----------------	--------------------	----------------------	---

#### RG11 CCS DUAL SHIELDED COAXIAL CABLE SWEPT TO 3.0 GHZ

**Residential**  
NON-PLENUM



##### Features & Benefits:

- 14 AWG solid copper clad steel conductor
- Gas injected cellular polyethylene dielectric
- Dual shield foil + 60% aluminum
- Flame rated PVC jacket
- 3.0 GHz sweep for all CATV through DBS needs
- NEC CM, CEC CM FT4, RoHS compliant
- 1000 foot spools

##### RG11-CATV

##### Application:

- CATV/MATV and direct broadcast satellite (DBS)
- Cable modem, Non-DC pass circuits
- High frequency RF modulated signals

NOM OD (INCHES): 0.405	AWG SIZE: 14	# OF PAIRS: N/A	# OF CONDUCTORS 1	AVAILABLE JACKET COLORS: ● PART NUMBER COLOR ID: BLK
---------------------------	-----------------	--------------------	----------------------	---

## RG11 BARE COPPER DUAL SHIELDED COAXIAL OUTSIDE PLANT CABLE SWEPT TO 3.0 GHZ

**Residential**  
NON-PLENUM



**Features & Benefits:**

- 14 AWG solid copper clad steel conductor
- Gas-injected cellular polyethylene dielectric
- Dual shield foil + 60% aluminum + floodant compound
- Polyethylene jacket
- 3.0 GHz sweep for all CATV through DBS needs
- Direct burial, sunlight resistant, RoHS compliant
- 1000 foot spools

**RG11-BC-CATV-DB**

**Application:**

- Outside plant, direct burial
- CATV/MATV and direct broadcast satellite (DBS)
- Cable modem, DC pass circuits
- High frequency RF modulated signals

NOM OD (INCHES): .395	AWG SIZE: 14	# OF PAIRS: N/A	# OF CONDUCTORS 1	AVAILABLE JACKET COLORS: ● ○ PART NUMBER COLOR ID: BLK WHT
--------------------------	-----------------	--------------------	----------------------	---

## RG6 BARE COPPER DUAL SHIELDED COAXIAL OUTSIDE PLANT CABLE SWEPT TO 3.0 GHZ

**Residential**  
NON-PLENUM, **DIRECT BURIAL**



**Features & Benefits:**

- 18 AWG solid annealed bare copper conductor
- Gas injected cellular polyethylene dielectric
- Dual shield foil + 60% aluminum + Floodant compound
- Polyethylene jacket
- 3.0 GHz sweep for all CATV through DBS needs
- Direct burial, sunlight resistant, RoHS compliant
- 1000 foot spools

**RG6-BC-CATV-DB**

**Application:**

- Outside Plant, direct burial
- CATV/MATV and direct broadcast satellite (DBS)
- Cable modem, DC pass circuits
- High frequency RF modulated signals

NOM OD (INCHES): 0.272	AWG SIZE: 18	# OF PAIRS: N/A	# OF CONDUCTORS 1	AVAILABLE JACKET COLORS: ● ○ PART NUMBER COLOR ID: BLK
---------------------------	-----------------	--------------------	----------------------	---

## RG6 BARE COPPER QUAD SHIELDED RF VIDEO 3.0 GHZ CABLE

**Residential**  
NON-PLENUM



**Features & Benefits:**

- 18 AWG solid annealed bare copper conductor
- Gas injected cellular polyethylene dielectric
- Quad shield foil + 60% and foil + 40% aluminum
- Flame rated PVC jacket
- 3.0 GHz sweep for all CATV through DBS needs
- NEC CM, CEC CM FT4, RoHS compliant
- 1000 foot spools

**QUADFLEX-BC**

**Application:**

- CATV/MATV and direct broadcast satellite (DBS)
- Cable modem, DC pass circuits
- High frequency RF modulated signals



**TOOLS & ACCESSORIES**  
Save time and money!  
[See Page: 247](#)

NOM OD (INCHES): 0.288	AWG SIZE: 18	# OF PAIRS: N/A	# OF CONDUCTORS 1	AVAILABLE JACKET COLORS: ● ○ PART NUMBER COLOR ID: BLK WHT
---------------------------	-----------------	--------------------	----------------------	---

## RG6 CCS DUAL SHIELDED COAXIAL CABLE SWEPT TO 3.0 GHZ

**Residential**  
NON-PLENUM



**Features & Benefits:**

- 18 AWG solid copper clad steel conductor
- Gas injected cellular polyethylene dielectric
- Dual shield foil + 60% aluminum
- Flame rated PVC jacket
- 3.0 GHz sweep for all CATV through DBS needs
- NEC CM, CEC CM FT4, RoHS compliant
- 1000 foot spools

**RG6-CM**

**Application:**

- CATV/MATV and direct broadcast satellite (DBS)
- Cable modem, non-DC pass circuits
- High frequency RF modulated signals

NOM OD (INCHES): 0.269	AWG SIZE: 18	# OF PAIRS: N/A	# OF CONDUCTORS 1	AVAILABLE JACKET COLORS: ● ○ PART NUMBER COLOR ID: BLK WHT
---------------------------	-----------------	--------------------	----------------------	---

## RG6 DUAL CCS QUAD SHIELDED RF VIDEO 3.0 GHZ CABLE

**Residential**  
NON-PLENUM



**Features & Benefits:**

- 18 AWG solid copper clad steel conductor
- Gas injected cellular polyethylene dielectric
- Quad shield foil + 60% and foil + 40% aluminum
- 2 coaxial cables in parallel (SPT) and joined with a web
- Flame rated PVC jacket
- 3.0 GHz sweep for all CATV through DBS needs
- NEC CM, CEC CM FT4, RoHS compliant
- 1000 foot spools

**QUADFLEX-SIAM**

**Application:**

- CATV/MATV and direct broadcast satellite (DBS)
- Cable modem, non-DC pass circuits
- High frequency RF modulated signals

NOM OD (INCHES): 0.614	AWG SIZE: 18	# OF PAIRS: N/A	# OF CONDUCTORS 2	AVAILABLE JACKET COLORS: ●
				PART NUMBER COLOR ID: BLK

## RG6 CCS DUAL SHIELDED COAXIAL OUTSIDE PLANT CABLE SWEPT TO 3.0 GHZ

**Residential**  
NON-PLENUM, **DIRECT BURIAL**



**Features & Benefits:**

- 18 AWG solid copper clad steel conductor
- Gas injected cellular polyethylene dielectric
- Dual shield foil + 60% aluminum + Floodant compound
- Polyethylene jacket
- 3.0 GHz sweep for all CATV through DBS needs
- Direct burial, sunlight resistant, RoHS compliant
- 1000 foot spools

**RG6-CATV-DB**

**Application:**

- Outside plant, direct burial
- CATV/MATV and direct broadcast satellite (DBS)
- Cable modem, non-DC pass circuits
- High frequency RF modulated signals

NOM OD (INCHES): 0.274	AWG SIZE: 18	# OF PAIRS: N/A	# OF CONDUCTORS 1	AVAILABLE JACKET COLORS: ●
				PART NUMBER COLOR ID: BLK

## RF/CATV/DBS Video: Plenum Cables

Plenum rated products have passed the highest flame test, NFPA-262. These products have a suffix of "P" after the article code. Some examples of the ratings you will find on the jacket are CL2P, CL3P, CMP, and OFNP. Plenum rated products can go between floors in commercial building where environmental air or air handling requirements exist for those spaces.

Other locations that will commonly call out Plenum requirements are the airspaces between drop ceilings and the actual construction. Plenum ratings are also authorized for in-wall use and plenum is backwards compatible for Riser, General Purpose, and Limited Use. Plenum rated product should never be used as OSP cable.

## RG11 CCS QUAD SHIELDED RF VIDEO 3.0 GHZ CABLE

**Commercial**  
**PLENUM**



**Features & Benefits:**

- 14 AWG solid copper clad steel conductor
- Gas injected cellular fluoropolymer dielectric
- Dual shield foil + 60% aluminum
- Plenum rated fluoropolymer jacket
- 3.0 GHz sweep for all CATV through DBS needs
- NEC CMP, CEC CMP FT6, RoHS compliant
- 1000 foot spools

**RG11-QUAD-PL**

**Application:**

- CATV/MATV and direct broadcast satellite (DBS)
- Cable modem, non-DC pass circuits
- High frequency RF modulated signals

NOM OD (INCHES): 0.372	AWG SIZE: 14	# OF PAIRS: N/A	# OF CONDUCTORS 1	AVAILABLE JACKET COLORS: ○
				PART NUMBER COLOR ID: WHT

## RG11 CCS DUAL SHIELDED COAXIAL PLENUM CABLE SWEPT TO 3.0 GHZ

**Commercial**  
**PLENUM**



**Features & Benefits:**

- 14 AWG solid copper clad steel conductor
- Gas injected cellular fluoropolymer dielectric
- Dual shield foil + 60% aluminum
- Plenum rated PVC jacket
- 3.0 GHz sweep for all CATV through DBS needs
- NEC CMP, CEC CMP FT6, RoHS compliant
- 1000 foot spools

**RG11-P-CATV**

**Application:**

- CATV/MATV and direct broadcast satellite (DBS)
- Cable modem, non-DC pass circuits
- High frequency RF modulated signals



**CUSTOMER SERVICE**

We offer technical assistance on all of our products or applications! Call us at 800-530-899 or email: [orders@LibAV.com](mailto:orders@LibAV.com)

NOM OD (INCHES): 0.351	AWG SIZE: 14	# OF PAIRS: N/A	# OF CONDUCTORS 1	AVAILABLE JACKET COLORS: <input type="radio"/>
				PART NUMBER COLOR ID: WHT

## RG6 CCS QUAD SHIELDED RF VIDEO 3.0 GHZ PLENUM CABLE

**Commercial**  
**PLENUM**



**Features & Benefits:**

- 18 AWG solid copper clad steel conductor
- Gas injected cellular fluoropolymer dielectric
- Quad shield foil + 60% and foil + 40% aluminum
- Plenum rated PVC jacket
- 3.0 GHz sweep for all CATV through DBS needs
- NEC CMP, CEC CMP FT6, RoHS compliant
- 1000 foot spools

**RG6-QUAD-CMP**

**Application:**

- CATV/MATV and direct broadcast satellite (DBS)
- Cable modem, non-DC pass circuits
- High frequency RF modulated signals

NOM OD (INCHES): 0.274	AWG SIZE: 18	# OF PAIRS: N/A	# OF CONDUCTORS 1	AVAILABLE JACKET COLORS: <input checked="" type="radio"/> <input type="radio"/>
				PART NUMBER COLOR ID: BLK WHT

## RG6 CCS DUAL SHIELDED COAXIAL PLENUM CABLE SWEPT TO 3.0 GHZ

**Commercial**  
**PLENUM**



**Features & Benefits:**

- 18 AWG solid copper clad steel conductor
- Gas injected cellular fluoropolymer dielectric
- Dual shield foil + 60% aluminum
- Plenum rated PVC jacket
- 3.0 GHz sweep for all CATV through DBS needs
- NEC CMP, CEC CMP FT6, RoHS compliant
- 1000 foot spools

**RG6-P-CATV**

**Application:**

- CATV/MATV and direct broadcast satellite (DBS)
- Cable modem, non-DC pass circuits
- High frequency RF modulated signals

NOM OD (INCHES): 0.239	AWG SIZE: 18	# OF PAIRS: N/A	# OF CONDUCTORS 1	AVAILABLE JACKET COLORS: <input checked="" type="radio"/> <input type="radio"/>
				PART NUMBER COLOR ID: BLK WHT

# SECURITY

Need security wiring? Fire Alarm wiring? Liberty special systems cabling is manufactured for your needs. The HomeTrax™ security cables offer pressure extruded round jacketing for smooth pulling from a nested box packaging.

## Security: Non-Plenum Cables

Liberty's definition of non-plenum cable is basically no plenum. We have the following levels grouped under non-plenum so please pay attention to the ratings you need and require:

**RISER:** Signified by the suffix "R" after the article code. These include CL2R, CL3R, CMR, OFNR. The Riser rating indicates the cable has passed the UL1666 flame test. Riser rated cables are backwards compatible to general purpose and limited use cables and Riser ratings are permissible for substitution per the National Electric Code®. Riser rated products can go between floors in commercial building risers as long as there is no environmental air or air handling in those spaces. Riser ratings are authorized for in-wall use.

**GENERAL PURPOSE:** There are two levels of general purpose ratings. Ratings with a suffix of "G" after the article code are certified to the Canadian FT4 flame test. An example is a rating of CMG. If there is no rating suffix at all, such as CL2, CL3, CM, or

OFN then the cable has passed the US UL1685 vertical flame test. General purpose cables are backwards compatible to limited use cables. General purpose ratings are good for single floor use. They cannot be routed between floors except in 1 and 2 family residences.

**LIMITED USE:** Liberty generally does not stock or sell limited use cables. These are signified by a suffix of "X" after the article code. CL2X, CL3X, CMX for example. These are limited to 1 and 2 story, 1 and 2 family residences. They can be used in commercial spaces but only in approved conduit.

**OUTSIDE PLANT:** Also called OSP for short. This is product that has been certified for use in sunlight exposed and direct burial applications outdoors. Liberty OSP products meet all UL requirements for Sunlight Resistance and Direct Burial applications. The products have been tested for UL's crush resistance. At Liberty, we ensure compliance to all code requirements.

### FIRE ALARM SIGNALING AND CONTROL 18 AWG 4 CONDUCTOR CABLE

**Commercial  
NON-PLENUM**



**Features & Benefits:**

- Solid annealed bare copper conductors
- Semi rigid PVC insulation
- Twisted & unshielded
- Flame rated PVC jacket
- NEC FPLR, RoHS compliant
- 1000 foot spools

**18-4C-FPLR**

**Application:**

- Fire safety systems per NEC article 760
- Alarm, signaling, audio, control circuits
- Detection and notification systems



**TOOLS & ACCESSORIES**  
Save time and money!  
See Page: 247

NOM OD (INCHES): 0.155	AWG SIZE: 18	# OF PAIRS: N/A	# OF CONDUCTORS 4	AVAILABLE JACKET COLORS: <span style="color: red;">●</span>
				PART NUMBER COLOR ID: RED

### HOMETRAX™ ECONOMY 22 AWG 2 SOLID CONDUCTOR SECURITY CABLE

**Residential  
NON-PLENUM**

**HomeTrax**  
ECONOMY CABLE

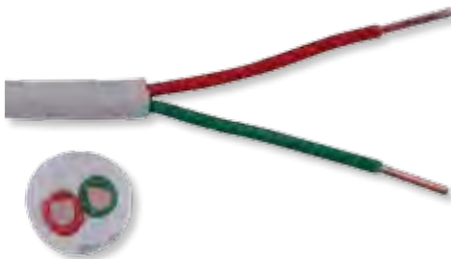

**Features & Benefits:**

- HomeTrax® economy construction security cable
- Solid annealed bare copper conductors
- Semi rigid PVC insulation
- Parallel lay, unshielded
- Flame rated pressured PVC jacket
- NEC CMG, CEC CMG FT4, RoHS compliant
- 1000 foot nested pull boxes

**22-2C-SO-HT**

**Application:**

- Security contact closure, signaling
- Station wire POTS systems
- Class 2 and Class 3 low voltage power
- Instrumentation and control

NOM OD (INCHES): 0.101	AWG SIZE: 22	# OF PAIRS: N/A	# OF CONDUCTORS 2	AVAILABLE JACKET COLORS: <span style="color: gray;">○</span>
				PART NUMBER COLOR ID: WHT

**Residential  
NON-PLENUM**

**HomeTrax**  
ECONOMY CABLE



**Features & Benefits:**

- HomeTrax® economy construction security cable
- 7 strand annealed bare copper conductors
- Semi rigid PVC insulation
- Parallel lay, unshielded
- Flame rated PVC jacket
- NEC CMG, CEC CMG FT4, RoHS compliant
- 1000 foot nested pull boxes

**22-2C-ST-HT**

**Application:**

- Security contact closure, signaling
- Class 2 and Class 3 low voltage power
- Instrumentation and control



**TECH SPECS**  
Up-to-date and complete  
tech specs for all products  
available at [www.LibAV.com](http://www.LibAV.com)

NOM OD (INCHES): 0.101	AWG SIZE: 22	# OF PAIRS: N/A	# OF CONDUCTORS 2	AVAILABLE JACKET COLORS: <span style="color: gray;">○</span>
				PART NUMBER COLOR ID: WHT



## HOMETRAX™ ECONOMY 22 AWG 2 SOLID CONDUCTOR SECURITY CABLE

Residential  
NON-PLENUM

**HomeTrax**  
ECONOMY CABLE

**Features & Benefits:**

- HomeTrax® economy construction security cable
- Solid annealed bare copper conductors
- Semi rigid PVC insulation
- Parallel lay, unshielded
- Flame rated pressured PVC jacket
- NEC CMG, CEC CMG FT4, RoHS compliant
- 1000 foot nested pull boxes

**22-4C-SO-HT**

**Application:**

- Security contact closure, signaling
- Station wire POTS systems
- Class 2 and Class 3 low voltage power
- Instrumentation and control



NOM OD (INCHES): 0.137	AWG SIZE: 22	# OF PAIRS: N/A	# OF CONDUCTORS 2	AVAILABLE JACKET COLORS: <input type="radio"/>	PART NUMBER COLOR ID: WHT
---------------------------	-----------------	--------------------	----------------------	--	---------------------------

Residential  
NON-PLENUM

**HomeTrax**  
ECONOMY CABLE

**Features & Benefits:**

- HomeTrax® economy construction security cable
- 7 strand annealed bare copper conductors
- Semi rigid PVC insulation
- Parallel lay, unshielded
- Flame rated PVC jacket
- NEC CMG, CEC CMG FT4, RoHS compliant
- 1000 foot nested pull boxes

**22-4C-ST-HT**

**Application:**

- Security contact closure, signaling
- Class 2 and Class 3 low voltage power
- Instrumentation and control

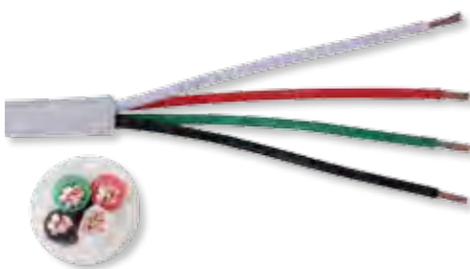

NOM OD (INCHES): 0.117	AWG SIZE: 22	# OF PAIRS: N/A	# OF CONDUCTORS 4	AVAILABLE JACKET COLORS: <input type="radio"/>	PART NUMBER COLOR ID: WHT
---------------------------	-----------------	--------------------	----------------------	--	---------------------------

**THE LIBERTY** **MONEY-SAVING SERVICES!**  
**EDGE** Go to [www.LibAV.com](http://www.LibAV.com) or contact your rep today to make Liberty an extension of your workforce!

## Security: Plenum Cables

Plenum rated products have passed the highest flame test, NFPA-262. These products have a suffix of "P" after the article code. Some examples of the ratings you will find on the jacket are CL2P, CL3P, CMP, and OFNP. Plenum rated products can go between floors in commercial building where environmental air or air handling requirements exist for those spaces.

Other locations that will commonly call out Plenum requirements are the airspaces between drop ceilings and the actual construction. Plenum ratings are also authorized for in-wall use and plenum is backwards compatible for Riser, General Purpose, and Limited Use. Plenum rated product should never be used as OSP cable.

## INTERCOM 22 AWG 2 PAIR WITH ONE PAIR SHIELDED PLENUM CABLE

Commercial  
PLENUM

**Features & Benefits:**

- Intercom systems infrastructure cable
- 7 strand annealed bare copper conductors
- Plenum rated PVC insulation
- One pair twisted & shielded and one pair twisted & unshielded
- Plenum rated PVC jacket
- NEC CMP, CEC CMP FT6, RoHS compliant
- 1000 foot spools, 2500 foot spools

**22-2P-PSH/UN**

**Application:**

- Intercom audio and power, microphone audio
- Balanced and unbalanced formats
- Security contact closure, signaling
- Class 2 and Class 3 low voltage power
- Instrumentation and control



NOM OD (INCHES): 0.138	AWG SIZE: 22	# OF PAIRS: 2	# OF CONDUCTORS 4	AVAILABLE JACKET COLORS: <input type="radio"/>	PART NUMBER COLOR ID: WHT
---------------------------	-----------------	------------------	----------------------	--	---------------------------



## “ SPEAKER AUDIO

Liberty has a wide variety of speaker cables for your needs. From our top of the line THX® Certified UltraCap speaker cable built tough for the discerning residential installer to our HomeTrax™ line of economy cabling we ensure quality and value. The ExtraFlex Plus™ series offers Oxygen Free 105 strand conductors and a brutally constructed super tough cable in perfect roundness. The KnockOut Plus™ series offers a thicker and smoother jacket with 65 strand conductors. Our Tight Tube Plenum™ is a true plenum rated speaker cable with higher stranding and thicker and smoother jacketing for ease of installation.



## Speaker Audio: Non-Plenum Cables

Liberty's definition of non-plenum cable is basically no plenum. We have the following levels grouped under non-plenum so please pay attention to the ratings you need and require:

**RISER:** Signified by the suffix "R" after the article code. These include CL2R, CL3R, CMR, OFNR. The Riser rating indicates the cable has passed the UL1666 flame test. Riser rated cables are backwards compatible to general purpose and limited use cables and Riser ratings are permissible for substitution per the National Electric Code®. Riser rated products can go between floors in commercial building risers as long as there is no environmental air or air handling in those spaces. Riser ratings are authorized for in-wall use.

**GENERAL PURPOSE:** There are two levels of general purpose ratings. Ratings with a suffix of "G" after the article code are certified to the Canadian FT4 flame test. An example is a rating of CMG. If there is no rating suffix at all, such as CL2, CL3, CM, or

OFN then the cable has passed the US UL1685 vertical flame test. General purpose cables are backwards compatible to limited use cables. General purpose ratings are good for single floor use. They cannot be routed between floors except in 1 and 2 family residences.

**LIMITED USE:** Liberty generally does not stock or sell limited use cables. These are signified by a suffix of "X" after the article code. CL2X, CL3X, CMX for example. These are limited to 1 and 2 story, 1 and 2 family residences. They can be used in commercial spaces but only in approved conduit.

**OUTSIDE PLANT:** Also called OSP for short. This is product that has been certified for use in sunlight exposed and direct burial applications outdoors. Liberty OSP products meet all UL requirements for Sunlight Resistance and Direct Burial applications. The products have been tested for UL's crush resistance. At Liberty, we ensure compliance to all code requirements.

### THX® CERTIFIED 12 AWG 1 PAIR SPEAKER CABLE

Residential 12 Gauge  
NON-PLENUM

**HomeTrax**  
ECONOMY CABLE

**Features & Benefits:**

- 261 strand annealed bare copper conductors
- Cellular polyethylene insulation
- Twisted & unshielded with paper tape binder
- Semi pressured flame rated PVC jacket
- THX® certified and low capacitance
- NEC CL3R, CEC CMG FT4 audio only, RoHS compliant
- 1000 foot spools



**12-1P-UC**

**Application:**

- Speaker level audio, home theater grade
- Best applications below 120 feet
- Class 2 and Class 3 low voltage power



NOM OD (INCHES): 0.389	AWG SIZE: 12	# OF PAIRS: 1	# OF CONDUCTORS 2	AVAILABLE JACKET COLORS: ● ○
				PART NUMBER COLOR ID: BLK WHT

### THX® CERTIFIED 12 AWG 2 PAIR SPEAKER CABLE

Residential 12 Gauge  
Non-Plenum

**Features & Benefits:**

- 261 strand annealed bare copper conductors
- Cellular polyethylene insulation
- Twisted & unshielded with paper tape binder
- Semi pressured flame rated PVC jacket
- THX® certified and low capacitance
- NEC CL3R, CEC CMG FT4 audio only, RoHS compliant
- 1000 foot spools



**12-2P-UC**

**Application:**

- Speaker level audio, home theater grade
- Best applications below 120 feet
- Class 2 and Class 3 low voltage power

NOM OD (INCHES): 0.478	AWG SIZE: 12	# OF PAIRS: 2	# OF CONDUCTORS 4	AVAILABLE JACKET COLORS: ○
				PART NUMBER COLOR ID: WHT

### THX® CERTIFIED 14 AWG 1 PAIR SPEAKER CABLE

Residential 14 Gauge  
NON-PLENUM

**Features & Benefits:**

- 168 strand annealed bare copper conductors
- Cellular polyethylene insulation
- Twisted & unshielded with paper tape binder
- Semi pressured flame rated PVC jacket
- THX® certified and low capacitance
- NEC CL3R, CEC CMG FT4 audio only, RoHS compliant
- 1000 foot spools



**14-1P-UC**

**Application:**

- Speaker level audio, home theater grade
- Best applications below 80 feet
- Class 2 and Class 3 low voltage power

NOM OD (INCHES): 0.347	AWG SIZE: 14	# OF PAIRS: 1	# OF CONDUCTORS 2	AVAILABLE JACKET COLORS: ○
				PART NUMBER COLOR ID: WHT

## THX® CERTIFIED 16 AWG 1 PAIR SPEAKER CABLE

**Residential**  
**NON-PLENUM**



**Features & Benefits:**

- 105 strand annealed bare copper conductors
- Cellular polyethylene insulation
- Twisted & unshielded with paper tape binder
- Semi pressured flame rated PVC jacket
- THX® certified and low capacitance
- NEC CL3R, CEC CMG FT4 audio only, RoHS compliant
- 1000 foot spools

**16-1P-UC**

**Application:**

- Speaker level audio, home theater grade
- Best applications below 40 feet
- Class 2 and Class 3 low voltage power



**New Website**  
**www.LibAV.com**  
**BETTER, STRONGER,**  
**EXPANSIVE!**

NOM OD (INCHES): 0.283	AWG SIZE: 16	# OF PAIRS: 1	# OF CONDUCTORS 2	AVAILABLE JACKET COLORS: <input type="radio"/>
				PART NUMBER COLOR ID: WHT

## EXTRAFLEX® 10 AWG 2 CONDUCTOR HEAVY DUTY SPEAKER CABLE

**Residential 12 Gauge**  
**NON-PLENUM**



**Features & Benefits:**

- 105 strand oxygen free copper conductors
- Semi rigid PVC insulation
- Twisted & unshielded with paper tape binder
- Semi pressured flame rated PVC jacket
- NEC CL2, CEC CMG FT4 audio only, RoHS compliant
- 1000 foot spools

**10-2C-EX+**

**Application:**

- Speaker level audio, home theater grade
- High wattage systems and infrastructure
- Class 2 low voltage power



**TNC & XLR**  
**CONNECTORS**  
See Page: 141

NOM OD (INCHES): 0.412	AWG SIZE: 10	# OF PAIRS: N/A	# OF CONDUCTORS 2	AVAILABLE JACKET COLORS: <input type="radio"/>
				PART NUMBER COLOR ID: WHT

## EXTRAFLEX® 12 AWG 2 CONDUCTOR HEAVY DUTY SPEAKER CABLE

**Residential 12 Gauge**  
**NON-PLENUM**



**Features & Benefits:**

- 105 strand oxygen free copper conductors
- Semi rigid PVC insulation
- Twisted & unshielded with paper tape binder
- Semi pressured flame rated PVC jacket
- NEC CL3, CEC CMG FT4 audio only, RoHS compliant
- 1000 foot spools

**12-2C-EX+**

**Application:**

- Speaker level audio, home theater grade
- Best applications below 120 feet
- Class 2 and Class 3 low voltage power

NOM OD (INCHES): 0.327	AWG SIZE: 12	# OF PAIRS: N/A	# OF CONDUCTORS 2	AVAILABLE JACKET COLORS: <input type="radio"/> <input checked="" type="radio"/>
				PART NUMBER COLOR ID: WHT TEA

## EXTRAFLEX® 12 AWG 4 CONDUCTOR HEAVY DUTY SPEAKER CABLE

**Residential 12 Gauge**  
**NON-PLENUM**

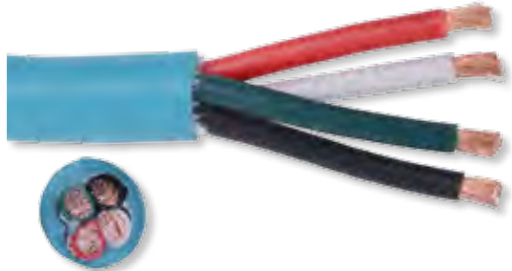

**Features & Benefits:**

- 105 strand oxygen free copper conductors
- Semi rigid PVC insulation
- Twisted & unshielded with paper tape binder
- Semi pressured flame rated PVC jacket
- NEC CL3, CEC CMG FT4 audio only, RoHS compliant
- 500 foot spools

**12-4C-EX+**

**Application:**

- Speaker level audio, home theater grade
- Best applications below 120 feet
- Class 2 and Class 3 low voltage power

NOM OD (INCHES): 0.378	AWG SIZE: 12	# OF PAIRS: N/A	# OF CONDUCTORS 4	AVAILABLE JACKET COLORS: <input type="radio"/> <input checked="" type="radio"/>
				PART NUMBER COLOR ID: WHT TEA

## EXTRAFLEX® 14 AWG 2 CONDUCTOR HEAVY DUTY SPEAKER CABLE

Residential 14 Gauge  
NON-PLENUM



### Features & Benefits:

- 105 strand oxygen free copper conductors
- Semi rigid PVC insulation
- Twisted & unshielded with paper tape binder
- Semi pressured flame rated PVC jacket
- NEC CL3, CEC CMG FT4 audio only, RoHS compliant
- 1000 foot spools

### 14-2C-EX+

#### Application:

- Speaker level audio, home theater grade
- Best applications below 80 feet
- Class 2 and Class 3 low voltage power



### TECH SPECS

Up-to-date and complete tech specs for all products available at [www.LibAV.com](http://www.LibAV.com)

NOM OD (INCHES): 0.287	AWG SIZE: 14	# OF PAIRS: N/A	# OF CONDUCTORS 2	AVAILABLE JACKET COLORS: <input type="radio"/> <input checked="" type="radio"/> <input checked="" type="radio"/>
				PART NUMBER COLOR ID: WHT PNK GRN

## EXTRAFLEX® 14 AWG 4 CONDUCTOR HEAVY DUTY SPEAKER CABLE

Residential 14 Gauge  
NON-PLENUM



### Features & Benefits:

- 105 strand oxygen free copper conductors
- Semi rigid PVC insulation
- Twisted & unshielded with paper tape binder
- Semi pressured flame rated PVC jacket
- NEC CL3, CEC CMG FT4 audio only, RoHS compliant
- 1000 foot spools

### 14-4C-EX+

#### Application:

- Speaker level audio, home theater grade
- Best applications below 80 feet
- Class 2 and 3 low voltage power

NOM OD (INCHES): 0.331	AWG SIZE: 14	# OF PAIRS: N/A	# OF CONDUCTORS 4	AVAILABLE JACKET COLORS: <input type="radio"/> <input checked="" type="radio"/> <input checked="" type="radio"/>
				PART NUMBER COLOR ID: WHT PNK GRN

## EXTRAFLEX® 16 AWG 2 CONDUCTOR HEAVY DUTY SPEAKER CABLE

Residential 16 Gauge  
NON-PLENUM



### Features & Benefits:

- 105 strand oxygen free copper conductors
- Semi rigid PVC insulation
- Twisted & unshielded with paper tape binder
- Semi pressured flame rated PVC jacket
- NEC CM, CEC CMG FT4 audio only, RoHS compliant
- 1000 foot spools

### 16-2C-EX+

#### Application:

- Speaker level audio, home theater grade
- Best applications below 50 feet
- Class 2 and Class 3 low voltage power



### COOL SPOOL SYSTEM®

Our exclusive reel box and hand truck means tangle-free pulls and total control  
See Page: 253

NOM OD (INCHES): 0.255	AWG SIZE: 16	# OF PAIRS: N/A	# OF CONDUCTORS 2	AVAILABLE JACKET COLORS: <input checked="" type="radio"/> <input type="radio"/> <input type="radio"/> <input type="radio"/> <input type="radio"/>
				PART NUMBER COLOR ID: BLK WHT RBL TEA GRN

## EXTRAFLEX® 16 AWG 4 CONDUCTOR HEAVY DUTY SPEAKER CABLE

Residential  
NON-PLENUM

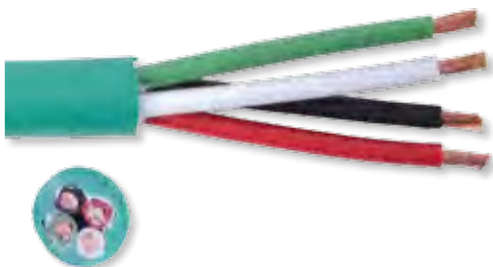

### Features & Benefits:

- 105 strand oxygen free copper conductors
- Semi rigid PVC insulation
- Twisted & unshielded with paper tape binder
- Semi pressured flame rated PVC jacket
- NEC CM, CEC CMG FT4 audio only, RoHS compliant
- 1000 foot spools

### 16-4C-EX+

#### Application:

- Speaker level audio, home theater grade
- Best applications below 50 feet
- Class 2 and Class 3 low voltage power

NOM OD (INCHES): 0.291	AWG SIZE: 16	# OF PAIRS: N/A	# OF CONDUCTORS 4	AVAILABLE JACKET COLORS: <input checked="" type="radio"/> <input type="radio"/> <input type="radio"/> <input type="radio"/> <input type="radio"/>
				PART NUMBER COLOR ID: BLK WHT PNK GRN RBL

## KNOCKOUT™ 14 AWG 2 CONDUCTOR SPEAKER CABLE

Residential  
NON-PLENUM



### Features & Benefits:

- 65 strand annealed bare copper conductors
- Semi rigid PVC insulation
- Twisted & unshielded
- Flame rated PVC jacket
- NEC CL3, CEC CMG FT4 audio only, RoHS compliant
- 1000 foot spools, 500 foot nested boxes, or Cool Spool System® boxes

### 14-2C-KO+

#### Application:

- Speaker level audio, home theater grade
- Best applications below 80 feet
- Class 2 and Class 3 low voltage power



**BARGAIN BIN!**  
**PRICES DROP DAILY**  
Check back daily for lower prices on overstock items!  
[www.LibAV.com](http://www.LibAV.com)

NOM OD (INCHES): 0.263	AWG SIZE: 14	# OF PAIRS: N/A	# OF CONDUCTORS 2	AVAILABLE JACKET COLORS: ● ○ PART NUMBER COLOR ID: BLK WHT
---------------------------	-----------------	--------------------	----------------------	---

## KNOCKOUT® 14 AWG 4 CONDUCTOR SPEAKER CABLE

Residential 14 Gauge  
NON-PLENUM



### Features & Benefits:

- 65 strand annealed bare copper conductors
- Semi rigid PVC insulation
- Twisted & unshielded
- Flame rated PVC jacket
- NEC CL3, CEC CMG FT4 audio only, RoHS compliant
- 1000 foot spools, 500 foot nested boxes, Cool Spool System® Boxes

### 14-4C-KO+

#### Application:

- Speaker level audio, home theater grade
- Best applications below 80 feet
- Class 2 and Class 3 low voltage power

NOM OD (INCHES): 0.313	AWG SIZE: 14	# OF PAIRS: N/A	# OF CONDUCTORS 4	AVAILABLE JACKET COLORS: ○ PART NUMBER COLOR ID: WHT
---------------------------	-----------------	--------------------	----------------------	---

## KNOCKOUT™ 16 AWG 4 CONDUCTOR SPEAKER CABLE

Residential  
NON-PLENUM



### Features & Benefits:

- 65 strand annealed bare copper conductors
- Semi rigid PVC insulation
- Twisted & unshielded
- Flame rated PVC jacket
- NEC CM, CEC CMG FT4 audio only, RoHS compliant
- 1000 foot spools, 500 foot nested boxes, Cool Spool System® Boxes

### 16-4C-KO+

#### Application:

- Speaker level audio, home theater grade
- Best applications below 50 feet
- Class 2 and Class 3 low voltage power



**GET THE EDGE!**  
CoolSpool System® means tangle-free pulls and easy transportation

NOM OD (INCHES): 0.269	AWG SIZE: 16	# OF PAIRS: N/A	# OF CONDUCTORS 4	AVAILABLE JACKET COLORS: ○ ● ● PART NUMBER COLOR ID: WHT LGN GRY
---------------------------	-----------------	--------------------	----------------------	---

## KNOCKOUT™ 16 AWG 2 CONDUCTOR SPEAKER CABLE

Residential  
NON-PLENUM



### Features & Benefits:

- 65 strand annealed bare copper conductors
- Semi rigid PVC insulation
- Twisted & unshielded
- Flame rated PVC jacket
- NEC CM, CEC CMG FT4 audio only, RoHS compliant
- 1000 foot spools, 1000 foot nested boxes, Cool Spool System® Boxes

### 16-2C-KO+

#### Application:

- Speaker level audio, home theater grade
- Best applications below 50 feet
- Class 2 and Class 3 low voltage power

NOM OD (INCHES): 0.231	AWG SIZE: 16	# OF PAIRS: N/A	# OF CONDUCTORS 2	AVAILABLE JACKET COLORS: ○ ● PART NUMBER COLOR ID: WHT LBL
---------------------------	-----------------	--------------------	----------------------	---

## DIRECT BURIAL SPEAKER CABLE 12 AWG 2 CONDUCTOR CABLE

**Direct Burial  
NON-PLENUM**



**Features & Benefits:**

- 19 strand annealed bare copper conductors
- Low density polyethylene insulation
- Twisted & unshielded
- UV stabilized PVC jacket
- NEC CL3, direct burial, sunlight resistant, RoHS compliant
- 1000 foot spools

**12-2C-DB**

**Application:**

- Outside plant speaker level audio
- 70 volt speaker cabling
- Low voltage lighting
- Class 2 and Class 3 low voltage power
- Instrumentation and control

NOM OD (INCHES): 0.322	AWG SIZE: 12	# OF PAIRS: N/A	# OF CONDUCTORS 2	AVAILABLE JACKET COLORS: ●	PART NUMBER COLOR ID: BLK
---------------------------	-----------------	--------------------	----------------------	----------------------------	---------------------------

## DIRECT BURIAL SPEAKER CABLE 12 AWG 4 CONDUCTOR CABLE

**Direct Burial  
NON-PLENUM**



**Features & Benefits:**

- 19 strand annealed bare copper conductors
- Low density polyethylene insulation
- Twisted & unshielded
- UV stabilized PVC jacket
- NEC CL3, direct burial, sunlight resistant, RoHS compliant
- 1000 foot spools

**12-4C-DB**

**Application:**

- Outside plant speaker level audio
- 70 volt speaker cabling
- Low voltage lighting
- Class 2 and Class 3 low voltage power
- Instrumentation and control

NOM OD (INCHES): 0.372	AWG SIZE: 12	# OF PAIRS: 2	# OF CONDUCTORS 4	AVAILABLE JACKET COLORS: ●	PART NUMBER COLOR ID: BLK
---------------------------	-----------------	------------------	----------------------	----------------------------	---------------------------

## DIRECT BURIAL SPEAKER CABLE 14 AWG 2 CONDUCTOR CABLE

**Direct Burial  
NON-PLENUM**



**Features & Benefits:**

- 19 strand annealed bare copper conductors
- Low density polyethylene insulation
- Twisted & unshielded
- UV stabilized PVC jacket
- NEC CL3, direct burial, sunlight resistant, RoHS compliant
- 1000 foot spools

**14-2C-DB**

**Application:**

- Outside plant speaker level audio
- 70 volt speaker cabling
- Low voltage lighting
- Class 2 and Class 3 low voltage power
- Instrumentation and control

NOM OD (INCHES): 0.284	AWG SIZE: 14	# OF PAIRS: N/A	# OF CONDUCTORS 2	AVAILABLE JACKET COLORS: ●	PART NUMBER COLOR ID: BLK
---------------------------	-----------------	--------------------	----------------------	----------------------------	---------------------------

## DIRECT BURIAL SPEAKER CABLE 14 AWG 4 CONDUCTOR CABLE

**Direct Burial  
NON-PLENUM**



**Features & Benefits:**

- 65 strand annealed bare copper conductors
- Semi rigid PVC insulation
- Twisted & unshielded
- Flame rated PVC jacket
- NEC CL3, CEC CMG FT4 audio only, RoHS compliant
- 1000 foot spools, 500 foot nested boxes, Cool Spool System® reel boxes

**14-4C-DB**

**Application:**

- Speaker level audio, home theater grade
- Best applications below 80 feet
- Class 2 and Class 3 low voltage power



**INSTALLER'S CHOICE  
SNAPRAX SERIES**  
See Page: 239

NOM OD (INCHES): 0.313 INCHES	AWG SIZE: 14	# OF PAIRS: N/A	# OF CONDUCTORS 4	AVAILABLE JACKET COLORS: ●	PART NUMBER COLOR ID: BLK
----------------------------------	-----------------	--------------------	----------------------	----------------------------	---------------------------

## DIRECT BURIAL SPEAKER CABLE 16 AWG 2 CONDUCTOR CABLE

**Direct Burial**  
**NON-PLENUM**



**Features & Benefits:**

- 19 strand annealed bare copper conductors
- Low density polyethylene insulation
- Twisted & unshielded
- UV stabilized PVC jacket
- NEC CL3, direct burial, sunlight resistant, RoHS compliant
- 1000 foot spools

**16-2C-DB**

**Application:**

- Outside plant speaker level audio
- 70 volt speaker cabling
- Low voltage lighting
- Class 2 and Class 3 low voltage power
- Instrumentation and control

NOM OD (INCHES): 0.240	AWG SIZE: 16	# OF PAIRS: N/A	# OF CONDUCTORS 2	AVAILABLE JACKET COLORS: ●	PART NUMBER COLOR ID: BLK
---------------------------	-----------------	--------------------	----------------------	----------------------------	---------------------------

## DIRECT BURIAL SPEAKER CABLE 16 AWG 4 CONDUCTOR CABLE

**Direct Burial**  
**NON-PLENUM**



**Features & Benefits:**

- 19 strand annealed bare copper conductors
- Low density polyethylene insulation
- Twisted & unshielded
- UV stabilized PVC jacket
- NEC CL3, direct burial, sunlight resistant, RoHS compliant
- 1000 foot spools

**16-4C-DB**

**Application:**

- Outside plant speaker level audio
- 70 volt speaker cabling
- Low voltage lighting
- Class 2 and Class 3 low voltage power
- Instrumentation and control

NOM OD (INCHES): 0.270	AWG SIZE: 16	# OF PAIRS: N/A	# OF CONDUCTORS 4	AVAILABLE JACKET COLORS: ●	PART NUMBER COLOR ID: BLK
---------------------------	-----------------	--------------------	----------------------	----------------------------	---------------------------

## HOMETRAX® ECONOMY 14 AWG 2 CONDUCTOR SPEAKER CABLE

**Residential 14 Gauge**  
**NON-PLENUM**

**HomeTrax**  
ECONOMY CABLE



**Features & Benefits:**

- HomeTrax® economy construction speaker cable
- 41 strand annealed bare copper conductors
- Semi rigid PVC insulation
- Twisted & unshielded
- Flame rated PVC jacket
- NEC CL3, CEC CMG FT4 audio only, RoHS compliant
- 500 foot nested pull boxes

**14-2C-HT**

**Application:**

- Speaker level audio, 70 volt speaker grade
- Best applications below 80 feet
- Class 2 and Class 3 low voltage power

NOM OD (INCHES): 0.222	AWG SIZE: 14	# OF PAIRS: N/A	# OF CONDUCTORS 2	AVAILABLE JACKET COLORS: ○	PART NUMBER COLOR ID: WHT
---------------------------	-----------------	--------------------	----------------------	----------------------------	---------------------------

## HOMETRAX® ECONOMY 14 AWG 4 CONDUCTOR SPEAKER CABLE

**Residential**  
**NON-PLENUM**

**HomeTrax**  
ECONOMY CABLE



**Features & Benefits:**

- HomeTrax® economy construction speaker cable
- 41 strand annealed bare copper conductors
- Semi rigid PVC insulation
- Twisted & unshielded
- Flame rated PVC jacket
- NEC CL3, CEC CMG FT4 audio only, RoHS compliant
- 500 foot nested pull boxes

**14-4C-HT**

**Application:**

- Speaker level audio, 70 volt speaker grade
- Best applications below 80 feet
- Class 2 and Class 3 low voltage power



**INSTALLER'S CHOICE**  
**SNAPRAX SERIES**  
See Page: 239

NOM OD (INCHES): 0.262	AWG SIZE: 14	# OF PAIRS: N/A	# OF CONDUCTORS 4	AVAILABLE JACKET COLORS: ○	PART NUMBER COLOR ID: WHT
---------------------------	-----------------	--------------------	----------------------	----------------------------	---------------------------



## HOMETRAX™ ECONOMY 16 AWG 2 CONDUCTOR SPEAKER CABLE

Residential  
NON-PLENUM

**HomeTrax**  
ECONOMY CABLE

**Features & Benefits:**

- HomeTrax® economy construction speaker cable
- 41 strand annealed bare copper conductors
- Semi rigid PVC insulation
- Twisted & unshielded
- Flame rated PVC jacket
- NEC CMG, CEC CMG FT4 audio only, RoHS compliant
- 500 foot nested pull boxes

**16-2C-HT**

**Application:**

- Speaker level audio, 70 volt Speaker
- Best applications below 50 feet
- Class 2 and Class 3 low voltage power



NOM OD (INCHES): 0.191	AWG SIZE: 16	# OF PAIRS: N/A	# OF CONDUCTORS 2	AVAILABLE JACKET COLORS: <input type="radio"/>	PART NUMBER COLOR ID: WHT
---------------------------	-----------------	--------------------	----------------------	--	---------------------------

## HOMETRAX™ ECONOMY 16 AWG 4 CONDUCTOR SPEAKER CABLE

Residential  
NON-PLENUM

**HomeTrax**  
ECONOMY CABLE

**Features & Benefits:**

- HomeTrax® economy construction speaker cable
- 41 strand annealed bare copper conductors
- Semi rigid PVC insulation
- Twisted & unshielded
- Flame rated PVC jacket
- NEC CMG, CEC CMG FT4 audio only, RoHS compliant
- 500 foot nested pull boxes

**16-4C-HT**

**Application:**

- Speaker level audio, 70 volt Speaker
- Best applications below 50 feet
- Class 2 and Class 3 low voltage power



NOM OD (INCHES): 0.224	AWG SIZE: 16	# OF PAIRS: N/A	# OF CONDUCTORS 4	AVAILABLE JACKET COLORS: <input type="radio"/>	PART NUMBER COLOR ID: WHT
---------------------------	-----------------	--------------------	----------------------	--	---------------------------

## ZIP CLEAR 12 AWG 2 CONDUCTOR SPEAKER CABLE

Residential

**Features & Benefits:**

- 261 strand oxygen free copper conductors
- Thermoplastic elastomer flexible insulation
- Parallel lay (SPT) zip clear construction
- Legs clearly marked for positive and negative
- Unbreakable 500 foot plastic spools

**12-2C-ZIP**

**Application:**

- Speaker level audio to 120 feet (recommended)

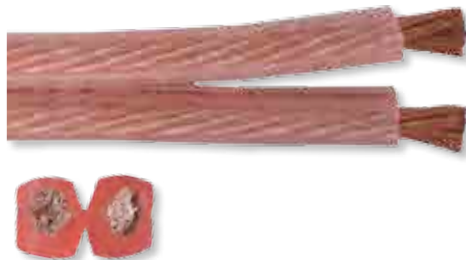

**TOOLS & ACCESSORIES**  
Save time and money!  
See Page: 247

NOM OD (INCHES): .354X.177	AWG SIZE: 12	# OF PAIRS: 1	# OF CONDUCTORS 2	AVAILABLE JACKET COLORS: <input type="radio"/>	PART NUMBER COLOR ID: CLR
-------------------------------	-----------------	------------------	----------------------	--	---------------------------

## ZIP CLEAR 14 AWG 2 CONDUCTOR SPEAKER CABLE

Residential

**Features & Benefits:**

- 105 strand oxygen free copper conductors
- Thermoplastic elastomer flexible insulation
- Parallel Lay (SPT) Zip Clear Construction
- Legs clearly marked for positive and negative
- Unbreakable 500 foot plastic spools
- NEC CL2, RoHS compliant

**14-2C-ZIP**

**Application:**

- Speaker level audio to 80 feet (recommended)
- In wall rated for concealed applications



NOM OD (INCHES): .276X.138	AWG SIZE: 14	# OF PAIRS: 1	# OF CONDUCTORS 2	AVAILABLE JACKET COLORS: <input checked="" type="radio"/>	PART NUMBER COLOR ID: BLK
-------------------------------	-----------------	------------------	----------------------	---	---------------------------

## Speaker Audio: Plenum Cables

Plenum rated products have passed the highest flame test, NFPA-262. These products have a suffix of "P" after the article code. Some examples of the ratings you will find on the jacket are CL2P, CL3P, CMP, and OFNP. Plenum rated products can go between floors in commercial building where environmental air or air handling requirements exist for those spaces.

Other locations that will commonly call out Plenum requirements are the airspaces between drop ceilings and the actual construction. Plenum ratings are also authorized for in-wall use and plenum is backwards compatible for Riser, General Purpose, and Limited Use. Plenum rated product should never be used as OSP cable.

### TIGHT TUBE PLENUM® 10 AWG 2 CONDUCTOR SPEAKER CABLE

Commercial  
**PLENUM**



**Features & Benefits:**

- 105 strand annealed bare copper conductors
- Plenum rated PVC insulation
- Twisted & unshielded
- Tight tube plenum rated PVC jacket
- NEC CL2P, CEC CMP FT6 audio only, RoHS compliant
- 1000 foot spools

**10-2C-TTP**

**Application:**

- Speaker level audio, audiophile commercial grade
- High wattage systems and infrastructure
- Class 2 low voltage power



**BARGAIN BIN  
PRICES DROP DAILY**  
[www.LibAV.com](http://www.LibAV.com)

NOM OD (INCHES): 0.323	AWG SIZE: 10	# OF PAIRS: N/A	# OF CONDUCTORS 2	AVAILABLE JACKET COLORS: <input type="radio"/>	PART NUMBER COLOR ID: WHT
---------------------------	-----------------	--------------------	----------------------	--	---------------------------

### TIGHT TUBE PLENUM® 12 AWG 2 CONDUCTOR SPEAKER CABLE

Commercial  
**PLENUM**



**Features & Benefits:**

- 65 strand Annealed bare copper conductors
- Plenum rated PVC Alloy insulation
- Twisted & unshielded
- Plenum rated PVC Jacket
- NEC CL2P, CEC CMP FT6 for audio only, RoHS compliant
- 1000 foot spools

**12-2C-TTP**

**Application:**

- Speaker level audio distribution
- 70V speaker systems
- DC Power, Class 2 and Class 3 power, system control

NOM OD (INCHES): 0.257	AWG SIZE: 12	# OF PAIRS: 1	# OF CONDUCTORS 2	AVAILABLE JACKET COLORS: <input type="radio"/>	PART NUMBER COLOR ID: WHT
---------------------------	-----------------	------------------	----------------------	--	---------------------------

### TIGHT TUBE PLENUM® 14 AWG 2 CONDUCTOR SPEAKER CABLE

Commercial  
**PLENUM**



**Features & Benefits:**

- 41 strand annealed bare copper conductors
- Plenum rated PVC insulation
- Twisted & unshielded
- Tight Tube Plenum rated PVC jacket
- NEC CL3P, CEC CMP FT6 audio only, RoHS compliant
- 1000 foot spools

**14-2C-TTP**

**Application:**

- Speaker level audio, audiophile commercial grade
- High wattage systems and infrastructure
- Class 2 and Class 3 low voltage power

NOM OD (INCHES): 0.216	AWG SIZE: 14	# OF PAIRS: N/A	# OF CONDUCTORS 2	AVAILABLE JACKET COLORS: <input type="radio"/>	PART NUMBER COLOR ID: WHT
---------------------------	-----------------	--------------------	----------------------	--	---------------------------

## TIGHT TUBE PLENUM® 16 AWG 2 CONDUCTOR SPEAKER CABLE

Commercial  
PLENUM



### Features & Benefits:

- 26 strand annealed bare copper conductors
- Plenum rated PVC insulation
- Twisted & unshielded
- Tight tube plenum rated PVC jacket
- NEC CMP, CEC CMP FT6, RoHS compliant
- 1000 foot spools

### 16-2C-TTP

#### Application:

- Speaker level audio, audiophile commercial grade
- High wattage systems and infrastructure
- Class 2 and Class 3 low voltage power

NOM OD (INCHES): 0.192	AWG SIZE: 16	# OF PAIRS: N/A	# OF CONDUCTORS 2	AVAILABLE JACKET COLORS: ● ○ PART NUMBER COLOR ID: BLK WHT
---------------------------	-----------------	--------------------	----------------------	---

## TIGHT TUBE PLENUM® 16 AWG 4 CONDUCTOR SPEAKER CABLE

Commercial  
PLENUM



### Features & Benefits:

- 26 strand annealed bare copper conductors
- Plenum rated PVC insulation
- Twisted & unshielded
- Tight tube plenum rated PVC jacket
- NEC CMP, CEC CMP FT6, RoHS compliant
- 1000 foot spools

### 16-4C-TTP

#### Application:

- Speaker level audio, audiophile commercial grade
- High wattage systems and infrastructure
- Class 2 and Class 3 low voltage power

NOM OD (INCHES): 0.217	AWG SIZE: 16	# OF PAIRS: N/A	# OF CONDUCTORS 4	AVAILABLE JACKET COLORS: ○ PART NUMBER COLOR ID: WHT
---------------------------	-----------------	--------------------	----------------------	---

## TIGHT TUBE PLENUM® 20 AWG 2 CONDUCTOR SHIELDED AUDIO CABLE

Commercial  
PLENUM



### Features & Benefits:

- 10 strand annealed bare copper conductors
- Plenum rated PVC insulation
- Twisted & shielded
- Tight tube plenum rated PVC jacket
- NEC CMP, CEC CMP FT6, RoHS compliant
- 1000 foot spools

### 20-2C-TTPSH

#### Application:

- Speaker level audio
- 70 volt speaker cabling
- Class 2 and Class 3 low voltage power
- Instrumentation and control

NOM OD (INCHES): 0.158	AWG SIZE: 20	# OF PAIRS: N/A	# OF CONDUCTORS 2	AVAILABLE JACKET COLORS: ● PART NUMBER COLOR ID: GRN
---------------------------	-----------------	--------------------	----------------------	---



# AUDIO C-TEC<sup>2</sup> SYSTEM

SEE PAGE 139  
FOR AUDIO  
C-TEC<sup>2</sup>  
CONNECTORS

SEE PAGE 248  
FOR TOOLS

Audio C-TEC<sup>2</sup> connectors slip on easily to the speaker cable conductor & compress on effortlessly with the easy-to-use Audio C-TEC<sup>2</sup> crimp tools!

Works with all Liberty speaker cable, for in-wall & non in-wall audio applications.

# STRUCTURED

“ Any home that is built today without a pre-installed smart home wiring package is not taking advantage of the cost advantages... Liberty has the solution with a variety of configurations for Structured Wiring Solutions. We've recently upgraded to Category 6 on the standard product so you can ensure that gigabit Ethernet and on-demand will have the bandwidth required of your end-user.



## Structured: Non-Plenum Cables

Liberty's definition of non-plenum cable is basically no plenum. We have the following levels grouped under non-plenum so please pay attention to the ratings you need and require:

**RISER:** Signified by the suffix "R" after the article code. These include CL2R, CL3R, CMR, OFNR. The Riser rating indicates the cable has passed the UL1666 flame test. Riser rated cables are backwards compatible to general purpose and limited use cables and Riser ratings are permissible for substitution per the National Electric Code®. Riser rated products can go between floors in commercial building risers as long as there is no environmental air or air handling in those spaces. Riser ratings are authorized for in-wall use.

**GENERAL PURPOSE:** There are two levels of general purpose ratings. Ratings with a suffix of "G" after the article code are certified to the Canadian FT4 flame test. An example is a rating of CMG. If there is no rating suffix at all, such as CL2, CL3, CM, or

OFN then the cable has passed the US UL1685 vertical flame test. General purpose cables are backwards compatible to limited use cables. General purpose ratings are good for single floor use. They cannot be routed between floors except in 1 and 2 family residences.

**LIMITED USE:** Liberty generally does not stock or sell limited use cables. These are signified by a suffix of "X" after the article code. CL2X, CL3X, CMX for example. These are limited to 1 and 2 story, 1 and 2 family residences. They can be used in commercial spaces but only in approved conduit.

**OUTSIDE PLANT:** Also called OSP for short. This is product that has been certified for use in sunlight exposed and direct burial applications outdoors. Liberty OSP products meet all UL requirements for Sunlight Resistance and Direct Burial applications. The products have been tested for UL's crush resistance. At Liberty, we ensure compliance to all code requirements.

### STRUCTURED 16 AWG 4 CONDUCTOR SPEAKER AND U/UTP CATEGORY 5E KEYPAD/AUDIO SIAMESE CABLE

Residential  
NON-PLENUM



**Features & Benefits:**

- Siamese composite cable for keypad and Volume control
- UTP category 5e and speaker cable joined by a web
- 16 AWG 65 strand annealed bare copper speaker wires
- Both components twisted, unshielded
- Flame rated PVC jacket
- NEC CM, CEC CMG FT4, RoHS compliant
- 500 foot spools

**AUDIOCAT-SIAMESE**

**Application:**

- Volume control single pull cable infrastructure
- 16 AWG supports up to 100w at 50 feet
- Low cost economical UTP for IR and control hookup
- Class 2 and Class 3 low voltage power
- Instrumentation and control

NOM OD (INCHES): 0.504	AWG SIZE: 24/16	# OF PAIRS: 4	# OF CONDUCTORS 12	AVAILABLE JACKET COLORS: PART NUMBER COLOR ID:
				● PUR

### STRUCTURED 16 AWG 4 CONDUCTOR SPEAKER AND U/UTP CATEGORY 5E KEYPAD/AUDIO CABLE

Residential  
NON-PLENUM

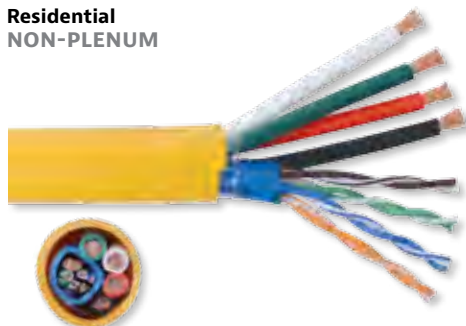

**Features & Benefits:**

- Structured composite cable for keypad and volume control
- Jacketed UTP category 5e and 4 speaker wires under one jacket
- 105 strand oxygen free copper speaker wires
- Components cabled together and unshielded
- Flame rated PVC jacket
- NEC CM, CEC CMG FT4, RoHS compliant
- 500 foot spools

**AUDIOCAT+**

**Application:**

- Volume control single pull cable infrastructure
- 16 AWG supports up to 100w at 50 feet
- Low cost economical UTP for IR and control hookup
- Class 2 and Class 3 low voltage power
- Instrumentation and control

NOM OD (INCHES): 0.394	AWG SIZE: 24/16	# OF PAIRS: 4	# OF CONDUCTORS 12	AVAILABLE JACKET COLORS: PART NUMBER COLOR ID:

## RGB RETROFIT 6 X 23 AWG MINI-RG59 SDI COAXES AND 2 X U/UTP CATEGORY 5E COMPOSITE CABLE

**Residential**  
**NON-PLENUM**



**Features & Benefits:**

- Structured composite 2 network and 6 coaxial cable
- 2 category 5e U/UTP LAN plus 6 MRG59 dual shield SDI coax cables
- All 8 components cabled and overall jacketed
- 350 MHz category 5e and 3.0 GHz coaxial sweep test
- Flame rated PVC jacket
- NEC CMR, CEC CMG FT4, RoHS compliant
- 500 foot spools

**RGB6C-23-2L5E**

**Application:**

- Horizontal LAN 10/100/1000BaseT ethernet
- Audio, video, infrared, IP control, CATV, DBS
- Balun infrastructure, voice, voice over IP
- PoE, HDBaseT, analog and digital media
- Baseband video, security video, digital audio

NOM OD (INCHES): 0.627	AWG SIZE: 24/23	# OF PAIRS: 8	# OF CONDUCTORS 22	AVAILABLE JACKET COLORS: ●
				PART NUMBER COLOR ID: BLK

## STRUCTURED SOLUTIONS 2 RG6HD +2 CATEGORY 6 UTP JACKETED COMPOSITE CABLE

**Residential**  
**NON-PLENUM**

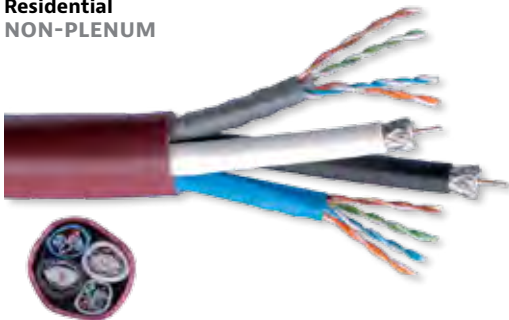

**Features & Benefits:**

- Structured composite 2 network and 2 coaxial cable
- 2 category 6 U/UTP LAN plus 2 RG6 dual shield SDI cables
- All 4 components cabled and overall jacketed
- 550 MHz category 6 and 3.0 GHz coaxial sweep test
- Flame rated PVC jacket
- NEC CM, CEC CMG FT4, RoHS compliant
- 500 foot spools

**CEBUS+-2N2**

**Application:**

- Horizontal LAN 10/100/1000BaseT ethernet
- Audio, video, infrared, IP control, CATV, DBS
- Balun infrastructure, voice, voice over IP
- PoE, HDBaseT, analog and digital media
- Baseband video, security video, digital audio

NOM OD (INCHES): 0.689	AWG SIZE: 23/18	# OF PAIRS: 8	# OF CONDUCTORS 18	AVAILABLE JACKET COLORS: ●
				PART NUMBER COLOR ID: PUR

## STRUCTURED SOLUTIONS 2 RG6Q BC + 2 CATEGORY 6 + A 2 FIBER OM3 JACKETED COMPOSITE CABLE

**Residential**  
**NON-PLENUM**



**Features & Benefits:**

- Single pull multimedia cable design
- 2 RG6 bare copper quad shield RF cables
- 2 Category 6 U/UTP LAN cables
- 2 Fiber 50/125 OM3 multimode fiber cable
- All 5 Components under one overall jacket
- NEC CM, CEC CMG FT4, RoHS compliant
- 500 foot spools standard

**CEBUS-F**

**Application:**

- Smart home wiring with fiber optic support
- Structured cabling installations in residential apps
- Crestron, AMX, Savant fiber support
- RF video, CATV, DBS, MATV, security, cable modem
- LAN 10/100/1000BaseT ethernet, voice, voice over IP

NOM OD (INCHES): 0.670	AWG SIZE: 23/18	# OF PAIRS: 8	# OF CONDUCTORS 18	AVAILABLE JACKET COLORS: ●
				PART NUMBER COLOR ID: GRN

## STRUCTURED SOLUTIONS 2 RG6Q BC +2 CATEGORY 6 UTP JACKETED COMPOSITE CABLE

**Residential**  
**NON-PLENUM**

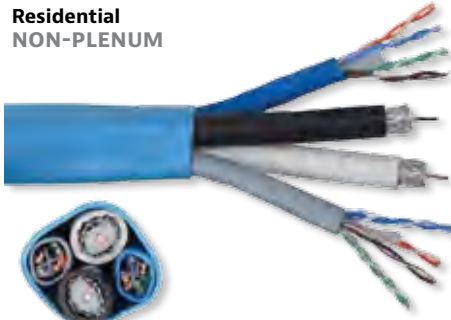

**Features & Benefits:**

- Structured composite 2 network and 2 coaxial cable
- 2 category 6 U/UTP LAN plus 2 RG6 quad shield DBS coax cables
- All 4 components cabled and overall jacketed
- 550 MHz category 6 and 3.0 GHz coaxial sweep test
- Flame rated PVC jacket
- NEC CM, CEC CMG FT4, RoHS compliant
- 500 foot spools

**CEBUS-2N2**

**Application:**

- Horizontal LAN 10/100/1000BaseT ethernet
- Audio, video, infrared, IP control, CATV, DBS
- Balun infrastructure, voice, voice over IP
- PoE, HDBaseT, analog and digital media

NOM OD (INCHES): 0.670	AWG SIZE: 23/18	# OF PAIRS: 8	# OF CONDUCTORS 18	AVAILABLE JACKET COLORS: ●
				PART NUMBER COLOR ID: LBL



**TOOLS & ACCESSORIES**  
Save time and money!  
See Page: 247

## STRUCTURED SOLUTIONS 4 X U/UTP CATEGORY 5E JACKETED COMPOSITE CABLE

Residential  
NON-PLENUM

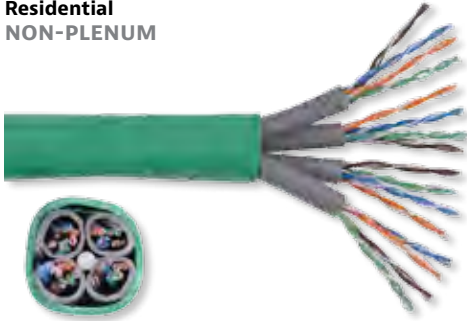

### Features & Benefits:

- Structured U/UTP Category 5e bundled cable
- 4 jacketed category 5e cables under one jacket
- Components cabled together and unshielded
- Flame rated PVC jacket
- NEC CM, CEC CMG FT4, RoHS compliant
- 500 foot spools

### CAT5E-4C-J

#### Application:

- Horizontal LAN 10/100/1000BaseT ethernet
- Audio, video, infrared, IP control
- Balun infrastructure, voice, voice over IP
- PoE, HDBaseT, analog and digital media

NOM OD (INCHES): 0.591	AWG SIZE: 24	# OF PAIRS: 16	# OF CONDUCTORS 32	AVAILABLE JACKET COLORS: ●	PART NUMBER COLOR ID: GRN
---------------------------	-----------------	-------------------	-----------------------	----------------------------	---------------------------

## STRUCTURED SOLUTIONS RG6Q BC + CATEGORY 5E UTP JACKETED COMPOSITE CABLE

Residential  
NON-PLENUM



### Features & Benefits:

- Siamese composite 1 network and 1 coaxial cable
- 1 category 5e U/UTP LAN plus 1 RG6 quad shield DBS coax cables
- UTP category 5e and coaxial cable joined by a web
- 550 MHz category 6 and 3.0 GHz coaxial sweep test
- Flame rated PVC jacket
- NEC CM, CEC CMG FT4, RoHS compliant
- 500 foot spools

### CEBUS-CM-1N1-SIAM

#### Application:

- Horizontal LAN 10/100/1000BaseT ethernet
- Audio, video, infrared, IP control, CATV, DBS
- Balun infrastructure, voice, voice over IP
- PoE, HDBaseT, analog and digital media

NOM OD (INCHES): 0.512	AWG SIZE: 24/18	# OF PAIRS: 4	# OF CONDUCTORS 9	AVAILABLE JACKET COLORS: ●	PART NUMBER COLOR ID: ORG
---------------------------	--------------------	------------------	----------------------	----------------------------	---------------------------

# BETTER, STRONGER, EXPANSIVE!

Liberty's brand new expansive website has all of the complete information and tools you need to easily research and get what you need for your next profitable installation job.

## RUN WITH US



## www.LibAV.com

- Keep all of your custom information and part numbers in a **password-protected area**
- Utilize our **Learning Center** for training videos, white papers and online product info
- Find complete, **up-to-date specs**, information and cross reference
- Check out our **super high-res product photography** & download any image you need
- Download any of our **literature** including our catalog, sell sheets & application brochures
- Find great deals on closeout items in our **Bargain Bin**, where prices drop daily
- Easily find our newest products right on the front page in our **Product Showcase**



## WIRELESS BROADCAST

“ Liberty has long had RG58 in Riser and Plenum in low loss dual shielded true RF195 formats. We have added RG8 Riser and Plenum in low loss dual shielded true RF400 formats. Wireless Microphones, Microwave, Ham Radio, and Satellite Radio are common applications. Wireless inventory control systems, we have a cable for that. ”



### Wireless Broadcast: Non-Plenum Cables

Liberty's definition of non-plenum cable is basically no plenum. We have the following levels grouped under non-plenum so please pay attention to the ratings you need and require:

**RISER:** Signified by the suffix "R" after the article code. These include CL2R, CL3R, CMR, OFNR. The Riser rating indicates the cable has passed the UL1666 flame test. Riser rated cables are backwards compatible to general purpose and limited use cables and Riser ratings are permissible for substitution per the National Electric Code®. Riser rated products can go between floors in commercial building risers as long as there is no environmental air or air handling in those spaces. Riser ratings are authorized for in-wall use.

**GENERAL PURPOSE:** There are two levels of general purpose ratings. Ratings with a suffix of "G" after the article code are certified to the Canadian FT4 flame test. An example is a rating of CMG. If there is no rating suffix at all, such as CL2, CL3, CM, or

OFN then the cable has passed the US UL1685 vertical flame test. General purpose cables are backwards compatible to limited use cables. General purpose ratings are good for single floor use. They cannot be routed between floors except in 1 and 2 family residences.

**LIMITED USE:** Liberty generally does not stock or sell limited use cables. These are signified by a suffix of "X" after the article code. CL2X, CL3X, CMX for example. These are limited to 1 and 2 story, 1 and 2 family residences. They can be used in commercial spaces but only in approved conduit.

**OUTSIDE PLANT:** Also called OSP for short. This is product that has been certified for use in sunlight exposed and direct burial applications outdoors. Liberty OSP products meet all UL requirements for Sunlight Resistance and Direct Burial applications. The products have been tested for UL's crush resistance. At Liberty, we ensure compliance to all code requirements.

#### MICROWAVE AND WIRELESS RF195 RG58 SOLID DUAL SHIELD CABLE

Wireless Broadcast  
NON-PLENUM



**Features & Benefits:**

- True RF-195 sized wireless broadcast cable
- 19 AWG solid annealed bare copper conductor
- Gas injected cellular polyethylene dielectric
- Dual shield 100% foil and 95% tinned copper braid
- Flame rated PVC jacket
- 2.5 GHz sweep, very low loss, excellent VSWR
- NEC CMR, CEC CMR FT4, RoHS compliant
- 1000 foot spools

**RG58-CMR**

**Application:**

- Antenna pigtailed, inventory control systems
- Satellite radio cabling, microwave signals
- Wireless communications, instrumentation
- Ham radio, CB radio, cellular nodes



**New Website**  
[www.LibAV.com](http://www.LibAV.com)  
**BETTER, STRONGER, EXPANSIVE!**

NOM OD (INCHES): 0.195	AWG SIZE: 19	# OF PAIRS: N/A	# OF CONDUCTORS 1	AVAILABLE JACKET COLORS: ● PART NUMBER COLOR ID: BLK
---------------------------	-----------------	--------------------	----------------------	---

#### MICROWAVE AND WIRELESS RF400 RG8 SOLID DUAL SHIELD CABLE

Wireless Broadcast  
NON-PLENUM



**Features & Benefits:**

- True RF-400 sized wireless broadcast cable
- 10 AWG solid copper clad aluminum conductor
- Gas injected cellular polyethylene dielectric
- Dual shield 100% foil and 95% tinned copper braid
- Flame rated PVC jacket
- 6.0 GHz sweep, very low loss, excellent VSWR
- NEC CMR, CEC CMR FT4, sunlight resistant, RoHS compliant
- 1000 foot spools

**RG8-CMR**

**Application:**

- Antenna pigtailed, inventory control systems
- Satellite radio cabling, microwave signals
- Wireless communications, instrumentation
- Ham radio, CB radio, cellular nodes

NOM OD (INCHES): 0.405	AWG SIZE: 10	# OF PAIRS: N/A	# OF CONDUCTORS 1	AVAILABLE JACKET COLORS: ● PART NUMBER COLOR ID: BLK
---------------------------	-----------------	--------------------	----------------------	---

## Wireless Broadcast: Plenum Cables

Plenum rated products have passed the highest flame test, NFPA-262. These products have a suffix of "P" after the article code. Some examples of the ratings you will find on the jacket are CL2P, CL3P, CMP, and OFNP. Plenum rated products can go between floors in commercial building where environmental air or air handling requirements exist for those spaces.

Other locations that will commonly call out Plenum requirements are the airspaces between drop ceilings and the actual construction. Plenum ratings are also authorized for in-wall use and plenum is backwards compatible for Riser, General Purpose, and Limited Use. Plenum rated product should never be used as OSP cable.

### MICROWAVE AND WIRELESS RF195 RG58 SOLID DUAL SHIELD PLENUM CABLE

Wireless Broadcast  
**PLENUM**



**Features & Benefits:**

- True RF-195 sized wireless broadcast cable
- 19 AWG solid annealed bare copper conductor
- Gas injected cellular fluoropolymer dielectric
- Dual shield 100% foil and 95% tinned copper braid
- Plenum rated PVC jacket
- 2.5 GHz sweep, very low loss, excellent VSWR
- NEC CMP, CEC CMP FT6, RoHS compliant
- 1000 foot spools

**RG58-CMP**

**Application:**

- Antenna pigtails, inventory control systems
- Satellite radio cabling, microwave signals
- Wireless communications, instrumentation
- Ham radio, CB radio, cellular nodes



**COOL SPOOL SYSTEM®**  
Our exclusive reel box and hand truck means tangle-free pulls and total control  
[See Page: 253](#)

NOM OD (INCHES): 0.178	AWG SIZE: 19	# OF PAIRS: N/A	# OF CONDUCTORS 1	AVAILABLE JACKET COLORS: <input type="radio"/>
				PART NUMBER COLOR ID: WHT

### MICROWAVE AND WIRELESS RF400 RG8 SOLID DUAL SHIELD PLENUM CABLE

Wireless Broadcast  
**PLENUM**



**Features & Benefits:**

- True RF-400 sized wireless broadcast cable
- 10 AWG solid copper clad aluminum conductor
- Gas injected cellular fluoropolymer dielectric
- Dual shield 100% foil and 95% tinned copper braid
- Plenum rated PVDF jacket
- 6.0 GHz sweep, very low loss, excellent VSWR
- NEC CMP, CEC CMP FT6, RoHS compliant
- 1000 foot spools

**RG8-CMP**

**Application:**

- Antenna pigtails, inventory control systems
- Satellite radio cabling, microwave signals
- Wireless communications, instrumentation
- Ham radio, CB radio, cellular nodes

NOM OD (INCHES): 0.338	AWG SIZE: 10	# OF PAIRS: N/A	# OF CONDUCTORS 1	AVAILABLE JACKET COLORS: <input checked="" type="radio"/>
				PART NUMBER COLOR ID: BLK

# LIBERTY INVENTORY SERVICES



Liberty's on-site consigned inventory management system reduces procurement and carrying costs

THE LIBERTY  
**EDGE**

**CALL YOUR REP  
TODAY FOR DETAILS!  
800.530.8998**



# CABLE | NEC CABLE SUBSTITUTION & HIERARCHY CHART



NEC CABLE SUBSTITUTION AND HIERARCHY CHART										
Fire Resistance level highest to lowest	NEC Reference Article								Canada*	
Test Requirements	800	725	760	820	770	830	Comm.	PCC		
Plenum	CMP		FPLP		OFNP		BLP	CMP	FT6	
NFPA 262, CSA FT6		CL3P		CATVP		OFCP				
UL-910 Steiner Tunnel		CL2P								
Riser	CMR		FPLR		OFNR		BMR	CMR		
UL-1666		CL3R		CATVR		OFNR	BLR			
Vertical Shaft		CL2R								
General Purpose	CMG	PLTC	FPL		OFNG		BM	CMG	FT4	
UL-1685 or CSA FT4	CM	CL3		CATV	OFN	OFNG	BL	CM		
Vertical Tray or CSA FT4		CL2				OFC				
Dwellings	CMX							CMX		
UL-1581 or VW-1		CL3X		CATVX						
Vertical Flame		CL2X					BLX			
								CMH	FT1	

\*In 1996 Canada and the US Harmonized the fire codes for Communications Cables. 16 AWG and smaller cable sizes can be certified (UL) and C(UL) CMP, CMR, CMG, CM and CMX for similar applications in the US. The PCC FT code does not need to be marked on the cable in these instances. C(UL), C(ETL), CSA marking, or other approved certification agency marking is required to use these codes.

RATING	APPROVED SUBSTITUTIONS
CMP	No substitutions
CL3P	CMP
CL2P	CMP, CL3P
FPLP	CMP
CATVP	CMP, BLP
OFNP	No substitutions
OFCP	OFNP
BLP	CMP, CL3P
CMR	CMP
CL3R	CMP, CL3P, CMR
CL2R	CMP, CL3P, CL2P, CMR, CL3R
FPLR	CMP, CMR, FPLP
CATVR	CMP, CATVP, BLP, CMR, BLR
OFNR	OFNP
OFNR	OFNP, OFCP, OFNR
BMR	No substitutions

RATING	APPROVED SUBSTITUTIONS
BLR	CMP, CL3P, CMR, CL3R, BMR
CMG	CMP, CMR
CM	CMP, CMR, CMG
PLTC	No substitutions
CL3	CMP, CL3P, CMR, CL3R, CMG, CM, PLTC
CL2	CMP, CL3P, CL2P, CMR, CL3R, CL2R, CMG, CM, PLTC, CM
FPL	CMP, FPLP, CMR, FPLR, CMG, CM,
CATV	CMP, CATVP, BLP, BMR, BLR, CATVR, CMG, CM, BL
OFNG	OFNP, OFNR
OFN	OFNP, OFNR, OFNG
OFNG	OFNP, OFCP, OFNR, OFCR, OFN
OFC	OFNP, OFCP, OFNR, OFCR, OFN, OFCG
BM	BMR
BL	CMP, CL3P, BLP, CMR, CL3R, BMR, BLR, CMG, CM, CL3, BM

RATING	APPROVED SUBSTITUTIONS
CMX	CMP, CMR, CMG, CM
CL3X	CMP, CL3P, CMR, CL3R, CMG, CM, PLTC, CL3, CMX
CL2X	CMP, CL3P, CL2P, CMR, CL3R, CL2R, CMG, CM, PLTC, CL3, CL2, CMX, CL3X
CATVX	CMP, CATVP, BLP, BMR, BLR, CATVR, CMG, CM, BL, BLX
BLX	CMP, CL3P, BLP, CMR, CL3R, BMR, BLR, CMG, CM, CL3, BM, BL

Temperature: 60°C, 75°C, 105°C, 125°C. Higher temperature is OK to substitute for lower temperature rating

No temperature on jacket is equal to 60°C per NEC code

Special Note: Ratings MPP, MPR, MPG, and MP were phased out effective July 1, 2003

## Liberty Wire & Cable Abbreviation Key

BC:	Bare Copper	SH:	Shielded or Shield
(#)C:	Conductors	STR:	Stranded
CCS:	Copper Clad Steel	TC:	Tinned Copper
DB:	Direct Burial	TTP:	Tight Tube Plenum
CMP:	Communications Plenum	UN:	Unshielded
CMR:	Communications Riser	VID:	Video
EX:	ExtraFlex		
INDSH:	Individual Shield		
(#) P:	Pair		
P:	Plenum		
PLN:	Plenum		
Q:	Quad		



### TECH SPECS

Up-to-date and complete tech specs for all products available at [www.LibAV.com](http://www.LibAV.com)



**New Website**  
[www.LibAV.com](http://www.LibAV.com)  
**BETTER, STRONGER, EXPANSIVE!**



# CABLE | RESIDENTIAL WIRE SCHEDULE



Signal	Type	LWC P/N	Description (Fixed Install)	Diameter	Rating	Grade	Mating Connector			
Audio (Non Speaker)				(Inch)	(mm)	NEC	Balanced	Unbalanced	Crimp BNC	
Analog Audio	Balanced or Unbalanced	22-2P-SIAM-EZ	22 AWG 2 Pair Individually shielded Zip Broadcast Audio	0.275	7.0	CM	Best	NC3FXX, NC3MXX	ZD06-color	
Analog Audio	Balanced or Unbalanced	22-2P-SHEX	22 AWG 2 Pair Individually shielded ExtraFlex™	0.260	6.6	CL3R	Better	NC3FXX, NC3MXX	ZD06-color	
Analog Audio	Balanced or Unbalanced	22-2P-INDSH	22 AWG 2 Pair Individually shielded General Purpose	0.175	4.4	CMR	Good	NC3FXX, NC3MXX	ZD06-color	
Digital or Analog Audio	Unbalanced (Coaxial)	18-CMR-SD	RG6/U High Definition Serial Digital Coaxial Cable	0.272	6.9	CMR	Best	N/A	CM-RG6L series 112957	
Digital or Analog Audio	Unbalanced (Coaxial)	20-CMR-VIDEO	RG59/U High Definition Serial Digital Coaxial Cable	0.236	6.0	CMR	Better	N/A	CM-RG59M series 112951	
Digital or Analog Audio	Unbalanced (Coaxial)	23-MINI-SD	Mini RG59/U High Definition Serial Digital Coaxial Cable	0.165	4.2	CM	Good	N/A	CM-RGB23 series 112955	
Control										
Universal Control	AMX/CRESTRON	LUNIX-U	Ultralow Capacitance 105Ω twisted shielded pair with 18/2 power	0.246	6.2	CM	Best	OEM specific		
General Control	RS-232 Control	24-4P-SH-LIBI	Low Capacitance 24/4P stranded shielded control/data cable	0.210	5.3	CM	Best	DB9M, DB9F		
DATA										
Non LAN Data	RS232-RS485	24-2P-485	24 AWG 2 Pair twisted double shielded low capacitance 120Ω	0.326	8.3	CM	Best	NC5MXX, NC5FXX		
Non LAN Data	RS-232 Control	24-4P-SH-LIBI	Low Capacitance 24/4P stranded shielded control/data cable	0.210	5.3	CM	Good	DB9M, DB9F		
LAN Data	Category 6	24-4P-16-EN	23 AWG 4 Pair UTP Third Party verified Category 6	0.220	5.6	CMR	Best	100 011LW		
LAN Data	Category 5e	24-4P-15-EN	24 AWG 4 Pair UTP Third Party verified Category 5e	0.197	5.0	CMR	Good	100 003B		
Fiber										
Single Mode Fiber	Riser Single Mode	*FRISM-	* = Fiber count, Suffix D = Distribution, BO = Breakout, many styles	Varies		OFNR	Best	95-200 series		
Multi Mode OM3	Riser 62.5/125 Style	*FRIMM6-	* = Fiber count, Suffix D = Distribution, BO = Breakout, many styles	Varies		OFNR	Best	95-000 series		
Multi Mode OM4	Riser 50/125 Style	*FRIMM5-	* = Fiber count, Suffix D = Distribution, BO = Breakout, many styles	Varies		OFNR	Best	95-050 series		
Laser Optimized MM	Riser 50/125 Style Laser Optimized	*FRIMM10-	* = Fiber count, Suffix D = Distribution, BO = Breakout, many styles	Varies		OFNR	Best	95-050 * X-Series		
Intercom										
Analog Audio	Under 1000 Feet	20-2C-SH	20 AWG 2 Conductor twisted shielded general purpose	0.154	3.9	CMR	Good	NC3FXX, NC3MXX	ZD06-color	
Analog Audio	Over 1000 Feet	18-2C-SH	18 AWG 2 Conductor twisted shielded general purpose	0.169	4.3	CMR	Good	NC3FXX, NC3MXX	ZD06-color	
DC Power										
Remote Power Supply	Dependent wattage + distance	22-2C-GRY	22 AWG 1 Pair twisted unshielded general purpose	0.137	3.5	CMR	Good			
Remote Power Supply	Dependent wattage + distance	18-2C-GRY	18 AWG 2 Conductor twisted unshielded general purpose	0.169	4.3	CMR	Good			
RF										
Low Loss 50 Ohm	Wireless Networking	RG58-CMR	19 AWG Low Loss RG58 Riser 50Ω	0.195	5.0	CMR	Best	N/A	112116 112116	
Low Loss 50 Ohm	Wireless Networking	RG8-CMR-BLK	Low Loss flexible Coaxial WBC series in outdoor, Riser constructions	0.405	10.3	CMR	Best	N/A	112563 112563	
Video										
Analog Video	Composite Video	RG6-CCTV-CM	RG6/U Base Band Video Cable	0.264	6.7	CM	Best	N/A	CM-RG6L series 112957	
Analog Video	Composite Video	RG59-CCTV-CM	RG59/U Base Band Video Coaxial Cable	0.242	6.1	CM	Best	N/A	CM-RG59M series 112951	
Analog Video	S-Video	23-YCLL-SIAM	Mini RG59/U 23 AWG High Definition Serial Digital Coaxial Cable x 2	0.328	8.3	CM	Best	N/A	CM-RGB23 series 112955	
Analog Video	S-Video	SV-25-CM	25 AWG Solid 2 Coaxial jacketed S-Video Cable (flat)	0.270	6.9	CM	Best	N/A	CM-RGB25 series MHR-BNC	
Analog Video	S-Video	SV-PVC	26 AWG Stranded 2 Coaxial jacketed S-Video Cable (flat)	0.270	6.9	CL2	Best	N/A	CM-RGB26 series MHR-BNC	
Analog Video	YPbPr Component and HD Component	RGB3C-20-CMR	RG59/U High Definition Serial Digital x 3 Conductor jacketed	0.630	16.0	CMR	Best	N/A	CM-RG59M series 112951	
Analog Video	YPbPr Component and HD Component	RGB3C-23-CM	Mini RG59/U High Definition Serial Digital Coaxial Cable x 3 Jacketed	0.415	10.5	CM	Better	N/A	CM-RGB23 series 112955	
Analog Video	YPbPr Component and HD Component	RGB3-MINI	Mini RG59/U base band Coaxial Cable x 3 Jacketed	0.401	10.2	CMR	Best	N/A	CM-RGB25 series 112955	
Analog Video	RGBHV Video non-ID/DDC Compliant	RGB5C-23-CM	Mini RG59/U High Definition Serial Digital Coaxial Cable x 5 Jacketed	0.550	14.0	CM	Best	N/A	CM-RGB23 series 112955	
Analog Video	RGBHV Video non-ID/DDC Compliant	RGB5-MINI	Mini RG59/U base band Coaxial Cable x 5 Jacketed	0.500	12.7	CMR	Best	N/A	CM-RGB25 series 112955	
Analog Video	RGBHV Video non-ID/DDC Compliant	RGB5C-PVC	26 AWG Stranded 5 Coaxial jacketed RGBHV Cable	0.350	8.9	CL2	Best	N/A	CM-RGB26 series MHR-BNC	
Analog Video	RGBHV Video ID/DDC Compliant	RGB6C/22-2P	26 AWG Stranded 6 Coaxial plus 2 pair control	0.410	10.4	CL2	Best	N/A	CM-RGB26 series MHR-BNC	
Analog Video	Low Skew UTP	TRUPHASE	23 AWG 4 Pair UTP Low Skew Video Cable	0.205	5.2	CMR	Best	100 011LW	N/A	
Analog Video	CATV	RG6-CM	RG6/U CCS Dual Shield CATV 3.0 GHz	0.272	6.9	CM	Best	N/A	CM-RG6L series 112957	
Digital Video	DBS/Broadband	QUADFLEX-BC	RG6/U Quad Shield Bare Copper CATV 3.0 GHz	0.287	7.3	CM	Best	N/A	CM-RG6L series 112957	
Digital Video	SMPT Standards	18-CMR-SD	RG6/U High Definition Serial Digital Coaxial Cable	0.272	6.9	CMR	Best	N/A	CM-RG6L series 112957	
Digital Video	SMPT Standards	20-CMR-VIDEO	RG59/U High Definition Serial Digital Coaxial Cable	0.236	6.0	CMR	Best	N/A	CM-RG59M series 112951	
Voice/Phone										
Telephone/Voice	Low speed Data, telephone, DSL	24-4P-15-EN	24 AWG 4 Pair UTP Third Party verified Category 5e	0.197	5.0	CMR	Best	100 003B	N/A	
Telephone/Voice	Low speed Data, telephone, DSL	24-2P-L3	24 AWG 2 Pair UTP Third Party verified Category 3	0.150	3.8	CMR	Better	100 026LW		
Telephone/Voice	Low speed Data, telephone, DSL	22-4C-SO-HT	22 AWG 4 Conductor Solid Station wire	0.152	3.9	CMG	Best			
Security										
Camera	Pan-Tilt-Zoom (PTZ) Applications	RG59CM-18-2C	Baseband RG59/U siamesed with 18/2C Control/Power	0.468	11.9	CM	Best	N/A	CM-RG59M series 112951	
Sensor/General	DC Power, Sensor, System	22-4C-ST-HT	22 AWG 4 Conductor twisted unshielded general purpose	0.142	3.6	CMG	Best			
Speaker				(Inch)	(mm)	NEC	Balanced	Unbalanced	Crimp BNC	
Speaker	Amplified Audio	12-1P-UC	THX™ Certified 12 AWG 1 Pair Ultra-Low Capacitance twisted unshielded	0.389	9.9	CL3R	Best		CM-A-12	
Speaker	Amplified Audio	12-2P-UC	THX™ Certified 12 AWG 2 Pair Ultra-Low Capacitance twisted unshielded	0.478	12.1	CL3R	Best		CM-A-12	
Speaker	Amplified Audio	14-1P-UC	THX™ Certified 14 AWG 1 Pair Ultra-Low Capacitance twisted unshielded	0.347	8.8	CL3R	Best		CM-A-14	
Speaker	Amplified Audio	14-2P-UC	THX™ Certified 14 AWG 2 Pair Ultra-Low Capacitance twisted unshielded	0.408	10.4	CL3R	Best		CM-A-14	
Speaker	Amplified Audio	16-1P-UC	THX™ Certified 16 AWG 1 Pair Ultra-Low Capacitance twisted unshielded	0.283	7.2	CMR	Best		CM-A-16	
Speaker	Amplified Audio	10-2C-EX+	10 AWG 2 Conductor High Strand OFC twisted unshielded	0.412	10.5	CL2	Better		CM-A-12	
Speaker	Amplified Audio	12-2C-EX+	12 AWG 2 Conductor High Strand OFC twisted unshielded	0.327	8.3	CL3	Better		CM-A-12	
Speaker	Amplified Audio	12-4C-EX+	12 AWG 4 Conductor High Strand OFC twisted unshielded	0.378	9.6	CL3	Better		CM-A-12	
Speaker	Amplified Audio	14-2C-EX+	14 AWG 2 Conductor High Strand OFC twisted unshielded	0.287	7.3	CL3	Better		CM-A-14	
Speaker	Amplified Audio	14-4C-EX+	14 AWG 4 Conductor High Strand OFC twisted unshielded	0.335	8.5	CL3	Better		CM-A-14	
Speaker	Amplified Audio	16-2C-EX+	16 AWG 2 Conductor High Strand OFC twisted unshielded	0.255	6.5	CM	Better		CM-A-16	
Speaker	Amplified Audio	16-4C-EX+	16 AWG 4 Conductor High Strand OFC twisted unshielded	0.291	7.4	CM	Better		CM-A-16	
Speaker	Amplified Audio	14-2C-KO+	14 AWG 2 Conductor High Strand KnockOut twisted unshielded	0.268	6.8	CL3	Better		CM-A-14	
Speaker	Amplified Audio	14-4C-KO+	14 AWG 4 Conductor High Strand KnockOut twisted unshielded	0.313	8.0	CL3	Better		CM-A-14	
Speaker	Amplified Audio	16-2C-KO+	16 AWG 2 Conductor High Strand KnockOut twisted unshielded	0.231	5.9	CM	Better		CM-A-16	
Speaker	Amplified Audio	16-4C-KO+	16 AWG 4 Conductor High Strand KnockOut twisted unshielded	0.280	7.1	CM	Better		CM-A-16	
Speaker	Amplified Audio	14-2C-HT	14 AWG 2 Conductor HomeTrax™ twisted unshielded	0.222	5.6	CL3	Good		CM-A-14	
Speaker	Amplified Audio	14-4C-HT	14 AWG 4 Conductor HomeTrax™ twisted unshielded	0.262	6.7	CL3	Good		CM-A-14	
Speaker	Amplified Audio	16-2C-HT	16 AWG 2 Conductor HomeTrax™ twisted unshielded	0.191	4.9	CMG	Good		CM-A-16	
Speaker	Amplified Audio	16-4C-HT	16 AWG 4 Conductor HomeTrax™ twisted unshielded	0.224	5.7	CMG	Good		CM-A-16	

# CABLE RESIDENTIAL WIRE SCHEDULE



Signal	Type	LWC P/N	Description (Fixed Install)	Diameter	Rating	Grade	Mating Connector			
<b>Specialty</b>										
Multipurpose	Projector Application	RGB6C/22-2P	26 AWG stranded 6 Coaxial plus 2 pair control Jacketed	0.410	10.4	CL2	Best		CM-RGB26 series	MHR-BNC
Multipurpose	Retrofit Applications	RGB6C-25-2L5E	25 AWG Solid 6 Coaxial + 2 Cat5e UTP Jacketed	0.533	13.5	CM	Best		CM-RGB25 series	MHR-BNC
Multipurpose	Retrofit Applications	RGB6C-20/2L5E	20 AWG Solid 6 Coaxial + 2 Cat5e UTP Jacketed	0.960	24.4	CMR	Best		CM-RGB20 series	112951
Multipurpose	Rack Interconnection	23-MINI-SD	Mini RG59/U 23 AWG High Definition Serial Digital Coaxial Cable	0.165	4.2	CM	Best		CM-RGB23 series	112955
Analog Audio	Microphone	24-2P-STAR-BLK	24 AWG 2 Pair Star Quad style extra flexible Mic cable	0.240	6.1	CM	Best	NC5MXX, NC5FX		
<b>Lighting Control</b>										
Lighting Control	Lutron Systems Grafik Eye	LUTRON-GRN	22 AWG Shielded Pair+18 AWG Pair Green Stripe	0.230	5.8	CM	Best			
Lighting Control	Lutron Systems Grafik Eye 4000/5000/6000	LUTRON-RBL	22 AWG Shielded Pair+12 AWG Pair+18 AWG Sensor Blue stripe	0.300	7.6	CL3	Best			
Lighting Control	Lutron Systems Sivoia QED Control	LUTRON-RED	18 AWG Shielded Quad+18 AWG Sensor+16 AWG Pair Red Stripe	0.340	8.6	CL3	Best			
Lighting Control	Lutron Systems Keypad	LUTRON-YEL	22 AWG Shielded Pair + 18 AWG Pair Yellow Stripe	0.230	5.8	CM	Best			
Lighting Control	Lutron System EcoSystem™ Bus Cable	LUTRON-EBC	16 AWG 1 Pair twisted unshielded White jacket (Dual AWM 600V rating)	0.283	7.2	CM	Best			
Lighting Control	Lutron System EcoSystem™ Sensor Cable	LUTRON-ESC	22 AWG 5 Conductor twisted shielded white jacket (Dual AWM 600V rating)	0.293	7.4	CM	Best			
Lighting Control	DMX Control	24-2P-485	24 AWG 2 Pair twisted double shielded low capacitance 120Ω	0.326	8.3	CM	Best	NC5MXX, NC5FX		
<b>Composite</b>										
Structured Cabling	Smart Home Composite	CEBUS+2N2	2xRG6 High Def+2xCat6 UTP Jacketed	0.689	17.5	CM	Best	100 011W	CM-RG6L series	
Structured Cabling	Smart Home Composite	CEBUS-2N2-J-LBL	2xRG6 Bare Copper Quad+2xCat5e UTP Jacketed	0.670	17.0	CMG	Better	100 003B	CM-RG6L series	
Structured Cabling	Smart Home Composite	CEBUS-CM-F-J	2xRG6 Bare Copper Quad+2xCat5e UTP+2 Multimode Fiber Jacketed	0.670	17.0	CMG	Best	100 003B	CM-RG6L series	
<b>Specialty</b>										
Multipurpose	Rack Interconnection	INTERFLEX-SD	RG59/U High Definition Serial Digital Coaxial Cable	0.236	6.0	N/A	Best		CM-RG59M Series	112951
<b>Coax Connectors</b>										
Compression Style	C-Tec2 Mini High Resolution 25 AWG Solid	CM-RGB25-xxx	Nickel Plated RCA, Nickel Plated BNC, and Gold Plated RCA							
Compression Style	ConneTec™ Mini Hi-Res 26 AWG	CM-RGB26-xxx	Nickel and Gold Plated RCA, Nickel and Gold Plated BNC							
Compression Style	C-Tec2 Mini RG59 23 AWG	CM-RGB23-xxx	Nickel Plated RCA, Nickel Plated BNC, and Gold Plated RCA							
Compression Style	C-Tec2 Universal RG59	CM-RG59-xxx	Nickel Plated RCA, BNC, and F							
Compression Style	C-Tec2 Universal RG6 Plenum	CM-RG6M-xxx	Nickel Plated RCA, BNC, and F							
Compression Style	C-Tec2 Universal RG6 PVC	CM-RG6L-xxx	Nickel Plated RCA, BNC, and F							
Crimp Style	Liberty	MHR-BNC	4-Piece 75 Ohm Crimp BNC for 26 AWG mini Hi-Res Coaxial							
Crimp Style	Amphenol Connex	112955	3-Piece 75 Ohm Crimp BNC for 25 & 23 AWG mini Hi-Res Coaxial							
Crimp Style	Amphenol Connex	112951	3-Piece 75 Ohm Crimp BNC for RG59 Dual Shield							
Crimp Style	Amphenol Connex	112957	3-Piece 75 Ohm Crimp BNC for RG6 Dual Shield							
Solder Style	Liberty	ZD06-*	RCA Plug, Black Metal Body, Gold contacts 4mm cable							
Crimp Style	Liberty	MHR-RCA	4-Piece Crimp RCA for Mini High Res Coax (26/25 AWG)							

# CABLE COMMERCIAL PLENUM WIRE SCHEDULE

SIGNAL	TYPE	LWC P/N	DESCRIPTION (FIXED INSTALL)	DIAMETER		RATING	GRADE	MATING CONNECTOR		
				(Inch)	(mm)	NEC		Balanced	Unbalanced	Crimp BNC
<b>Audio (Non Speaker)</b>										
Analog Audio	Balanced or Unbalanced	24-1P-P-DIG-AUDIO	24 AWG 1 Pair twisted shielded ultra-low Capacitance AES/EBU	0.170	4.3	CMP	Best	NC3FX, NC3MXX	ZD06-color	
Analog Audio	Balanced or Unbalanced	22-1P-CMP-EZ	22 AWG 1 Pair twisted shielded Low Capacitance Broadcast Audio	0.130	3.3	CMP	Better	NC3FX, NC3MXX	ZD06-color	
Analog Audio	Balanced or Unbalanced	22-2E-PSH	22 AWG 1 Pair twisted shielded plenum	0.116	2.9	CMP	Good	NC3FX, NC3MXX	ZD06-color	
Digital or Analog Audio	Unbalanced (Coaxial)	18-CMP-VID-COAX	RG6/U High Definition Serial Digital Coaxial Cable	0.237	6.0	CMP	Best		CM-RG6M series	112519
Digital or Analog Audio	Unbalanced (Coaxial)	20-CMP-VID-COAX	RG59/U High Definition Serial Digital Coaxial Cable	0.207	5.3	CMP	Better		CM-RG59M series	112975
Digital or Analog Audio	Unbalanced (Coaxial)	23-MINI-CMP	Mini RG59/U Serial Digital Coaxial Cable	0.159	4.0	CMP	Good		CM-RGB23 series	112955
Digital Audio	Balanced	24-1P-P-DIG-AUDIO	24 AWG 1 Pair twisted shielded ultra-low Capacitance AES/EBU	0.170	4.3	CMP	Best	NC3FX, NC3MXX	ZD06-color	
<b>Control</b>										
Universal Control	AMX/CRESTRON	LUNIX-U-P	Low Capacitance 105Ω twisted shielded pair with 18/2 power	0.205	5.2	CMP	Best			
General Control	RS-232 Control	24-4P-PLCSH	Low Capacitance 24/4P stranded shielded control/data cable	0.210	5.3	CMP	Best	DB9M, DB9F		
General Control	RS-232 Control	22-2E-PSH	22 AWG 1 Pair twisted shielded plenum	0.116	2.9	CMP	Good	DB9M, DB9F	ZD06-color	
<b>DATA</b>										
Non LAN Data	RS232-RS485	24-2P-P485-WHT	24 AWG 2 Pair twisted double shielded Ultra-low capacitance 120Ω	0.277	7.0	CMP	Best	DB9M, DB9F		
Non LAN Data	RS-232 Control	24-4P-PLCSH	Low Capacitance 24/4P stranded shielded control/data cable	0.210	5.3	CMP	Best	DB9M, DB9F		
LAN Data	Category 6	24-4P-P-16-EN	23 AWG 4 Pair UTP Third Party verified Category 6	0.215	5.5	CMP	Best	100 011W		
LAN Data	Category 5e	24-4P-P-15-EN	24 AWG 4 Pair UTP Third Party verified Category 5e	0.180	4.6	CMP	Best	100 003B		
<b>Fiber</b>										
Single Mode Fiber	Plenum Single Mode	*FPISM-	* = Fiber count, Suffix D = Distribution, BO = Breakout, many styles	Varies		OFNP	Best	95-200 series		
Multi Mode OM3	Plenum 62.5/125 Style	*FPIMM6-	* = Fiber count, Suffix D = Distribution, BO = Breakout, many styles	Varies		OFNP	Best	95-000 series		
Multi Mode OM3	Plenum 50/125 Style	*FPIMM5-	* = Fiber count, Suffix D = Distribution, BO = Breakout, many styles	Varies		OFNP	Best	95-050 series		
Multi Mode OM3	Plenum 50/125 Style Laser Optimized	*FPIMM10-	* = Fiber count, Suffix D = Distribution, BO = Breakout, many styles	Varies		OFNP	Best	95-050 * -X series		
<b>Intercom</b>										
Analog Audio	Under 1000 Feet	22-1P-CMP-EZ	22 AWG 1 Pair twisted shielded Low Capacitance Broadcast Audio	0.130	3.3	CMP	Best	NC3FX, NC3MXX	ZD06-color	
Analog Audio	Under 1000 Feet	20-2C-PSH	20 AWG 2 Conductor twisted shielded plenum	0.130	3.3	CMP	Better	NC3FX, NC3MXX	ZD06-color	
Analog Audio	Over 1000 Feet	18-2C-PSH	18 AWG 2 Conductor twisted shielded plenum	0.156	4.0	CMP	Better	NC3FX, NC3MXX	ZD06-color	
<b>DC Power</b>										
Remote Power Supply	Dependent wattage + distance	22-2E-P	22 AWG 1 Pair twisted unshielded plenum	0.114	2.9	CMP	Good			
Remote Power Supply	Dependent wattage + distance	18-2C-P	18 AWG 2 Conductor twisted unshielded plenum	0.154	3.9	CMP	Good			
<b>RF</b>										
Low Loss 50 Ohm	Wireless Networking	RG58-CMP	19 AWG Low Loss RG58 Plenum 50Ω	0.178	4.5	CMP	Best			112128
Low Loss 50 Ohm	Wireless Networking	RG8-CMP-WHT	Low Loss flexible Coaxial WBC RG8 Plenum	0.355	9.0	CMP	Best			112627
<b>Video</b>										
Analog Video	Composite Video	RG6-CCTV-PL	RG6/U Base Band Video Cable	0.229	5.8	CMP	Best		CM-RG6M series	112519
Analog Video	Composite Video	RG59-CCTV-PL	RG59/U Base Band Video Coaxial Cable	0.193	4.9	CMP	Better		CM-RG59M series	112975
Analog Video	S-Video	SV-25-CMP	25 AWG Solid 2 Coaxial jacketed S-Video Cable (flat)	0.240	6.1	CMP	Best		CM-RGB25 series	MHR-BNC
Analog Video	S-Video	SV-PLN	26 AWG Stranded 2 Coaxial jacketed S-Video Cable (flat)	0.230	5.8	CL2P	Better		CM-RGB26 series	MHR-BNC

# CABLE COMMERCIAL PLENUM WIRE SCHEDULE



SIGNAL	TYPE	LWC P/N	DESCRIPTION (FIXED INSTALL)	DIAMETER	RATING	GRADE	MATING CONNECTOR		
Analog Video	RGBHV Video non-ID/DDC Compliant	RGBSC-25-CMP	Mini RG59/U base band Coaxial Cable x 5 Jacketed	0.315	8.0	CMP	Best	CM-RGB25S series	MHR-BNC
Analog Video	RGBHV Video non-ID/DDC Compliant	RGBSC-PLN	26 AWG Stranded 5 Coaxial jacketed RGBHV Cable	0.300	7.6	CMP	Better	CM-RGB26 series	MHR-BNC
Analog Video	RGBHV Video ID/DDC Compliant	RGB6C-25/22-2P-CMP	25 AWG solid 6 Coaxial plus 2 pair control	0.370	9.4	CMP	Best	CM-RGB25S series	MHR-BNC
Analog Video	RGBHV Video ID/DDC Compliant	RGB6C/22-2P-PLN	26 AWG stranded 6 Coaxial plus 2 pair control	0.370	9.4	CMP	Better	CM-RGB26 series	MHR-BNC
Analog Video	No Skew UTP	TRUPHASE-P	23 AWG 4 Pair UTP Low Skew Video Cable	0.170	4.3	CMP	Best	100 011LW	
Analog Video	CATV	RG6-QUAD-CMP	RG6/U CCS Quad Shield CATV 3.0 GHz	0.268	6.8	CMP	Best	CM-RG6M series	
Analog Video	CATV	RG6-P-CATV	RG6/U CCS Dual Shield CATV 3.0 GHz	0.239	6.1	CMP	Best	CM-RG6M series	112958
Digital Video	SMPT E Standards/DBS Broadband	18-CMP-VID-COAX	RG6/U High Definition Serial Digital Coaxial Cable	0.237	6.0	CMP	Best	CM-RG6M series	112958
Digital Video	SMPT E Standards/DBS Broadband	20-CMP-VID-COAX	RG59/U High Definition Serial Digital Coaxial Cable	0.207	5.3	CMP	Best	CM-RG59M series	112957
Voice/Phone									
Telephone/Voice	Low speed Data, telephone, DSL	24-4P-P-LS-EN	24 AWG 4 Pair UTP Third Party verified Category 5e	0.180	4.6	CMP	Best	100 003B	
Telephone/Voice	Low speed Data, telephone, DSL	24-2P-P-13	24 AWG 2 Pair UTP Third Party verified Category 3	0.133	3.4	CMP	Better	100 026LW	
Telephone/Voice	Low speed Data, telephone, DSL	22-4C-SOL-P	22 AWG 4 Conductor Solid Station wire	0.117	3.0	CMP	Good		
Security									
Camera	Pan-Tilt-Zoom (PTZ) Applications	RG59-18/2C-PS	Baseband RG59/U siamesed with 18/2C Control/Power (Zip)	0.380	9.7	CMP	Best	CM-RG59M series	112519
Sensor/General	DC Power, Sensor, System	22-4C-P	22 AWG 4 Conductor twisted unshielded plenum	0.144	3.7	CMP	Good		
Speaker									
Speaker	Amplified Audio	10-2C-TTP	10 AWG 2 Conductor twisted unshielded plenum	0.323	8.2	CL2P	Best	CM-A-12	
Speaker	Amplified Audio	12-2C-TTP	12 AWG 2 Conductor twisted unshielded Tight-Tube plenum	0.257	6.5	CL2P	Best	CM-A-12	
Speaker	Amplified Audio	12-2C-P	12 AWG 2 Conductor twisted unshielded plenum	0.258	6.6	CL3P	Better	CM-A-12	
Speaker	Amplified Audio	14-2C-TTP	14 AWG 2 Conductor twisted unshielded Tight-Tube plenum	0.216	5.5	CL2P	Best	CM-A-14	
Speaker	Amplified Audio	14-2C-P	14 AWG 2 Conductor twisted unshielded plenum	0.210	5.3	CL3P	Better	CM-A-14	
Speaker	Amplified Audio	16-4C-TTP	16 AWG 4 Conductor twisted unshielded Tight-Tube plenum	0.217	5.5	CMP	Best	CM-A-16	
Speaker	Amplified Audio	16-2C-P	16 AWG 2 Conductor twisted unshielded plenum	0.190	4.8	CMP	Better	CM-A-16	
Speaker	Amplified Audio	18-4C-TTP	18 AWG 4 Conductor twisted unshielded plenum	0.195	5.0	CMP	Best		
Speaker	Amplified Audio	18-2C-P	18 AWG 2 Conductor twisted unshielded plenum	0.154	3.9	CMP	Better		
Specialty									
Multipurpose	Projector Application	RGB6C-25/22-2P-CMP	25 AWG Solid 6 Coaxial plus 2 pair control	0.370	9.4	CL2P	Better	CM-RGB25S series	MHR-BNC
Multipurpose	Projector Application	RGB6C/22-2P-PLN	26 AWG stranded 6 Coaxial plus 2 pair control	0.370	9.4	CL2P	Good	CM-RGB26 series	MHR-BNC
Lighting Control									
Lighting Control	Lutron Systems Grafik Eye	LUTRON-P-GRN	22 AWG Shielded Pair+18 AWG Pair Green Stripe	0.195	5.0	CMP	Best		
Lighting Control	Lutron Systems Grafik Eye 4000/5000/6000	LUTRON-P-RBL	22 AWG Shielded Pair+12 AWG Pair+18 AWG Sensor Blue stripe	0.272	6.9	CL3P	Best		
Lighting Control	Lutron Systems Sivoia QED Control	LUTRON-P-RED	18 AWG Shielded Quad+18 AWG Sensor+16 AWG Pair Red Stripe	0.322	8.2	CL3P	Best		
Lighting Control	Lutron Systems Grafik Eye Keypad	LUTRON-P-YEL	22 AWG Shielded Pair + 18 AWG Pair Yellow Stripe	0.195	5.0	CMP	Best		
Lighting Control	Lutron System EcoSystem™ Bus Cable	LUTRON-P-EBL	16 AWG 1 Pair twisted unshielded plenum clear jacket	0.158	4.0	CMP	Best		
Lighting Control	Lutron System EcoSystem™ Sensor Cable	LUTRON-P-ESC	22 AWG 5 Conductor twisted shielded plenum clear jacket	0.134	3.4	CMP	Best		
Lighting Control	Vantage	16-2C-P-VANT	16 AWG Mid Capacitance twisted pair	0.195	5.0	CMP	Best		
Lighting Control	DMX Control	24-2P-P485-WHT	24 AWG 2 pair dual shielded RS-485 Cable	0.277	7.0	CMP	Best	NC5MXX, NC5FXX	
Coax Connectors									
Compression Style	C-Tec2 Mini High Resolution 25 AWG Solid	CM-RGB25S-xxx	Nickel Plated RCA, Nickel Plated BNC, and Gold Plated RCA						
Compression Style	ConneCTec™ Mini Hi-Res 26 AWG	CM-RGB26-xxx	Nickel and Gold Plated RCA, Nickel and Gold Plated BNC						
Compression Style	C-Tec2 Mini RG59 23 AWG	CM-RGB23-xxx	Nickel Plated RCA, Nickel Plated BNC, and Gold Plated RCA						
Compression Style	C-Tec2 Universal RG59	CM-RG59M-xxx	Nickel Plated RCA, BNC, and F						
Compression Style	C-Tec2 Universal RG6 Plenum	CM-RG6M-xxx	Nickel Plated RCA, BNC, and F						
Compression Style	C-Tec2 Universal RG6 PVC	CM-RG6L-xxx	Nickel Plated RCA, BNC, and F						
Crimp Style	Liberty	MHR-BNC	4-Piece 75 Ohm Crimp BNC for 26 AWG mini Hi-Res Coaxial						
Crimp Style	Amphenol Connex	112955	3-Piece 75 Ohm Crimp BNC for 23-MINI-CMP						
Crimp Style	Amphenol Connex	112975	3-Piece 75 Ohm Crimp BNC for 20-CMP-VIDEO						
Crimp Style	Amphenol Connex	112958	3-Piece 75 Ohm Crimp BNC for 18-CMP-VID-COAX						
Solder Style	Liberty	ZD06-*	RCA Plug, Black Metal Body, Gold contacts 4mm cable						
Crimp Style	Liberty	MHR-RCA	4-Piece Crimp RCA for Mini High Res Coax (26/25 AWG)						

# CABLE COMMERCIAL NON-PLENUM WIRE SCHEDULE

SIGNAL	TYPE	LWC P/N	DESCRIPTION (FIXED INSTALL)	DIAMETER	RATING	GRADE	MATING CONNECTOR			
Audio (Non Speaker)										
Analog Audio	Balanced or Unbalanced	24-1P-DIG-AUD	24 AWG 1 Pair twisted shielded ultra-low capacitance AES/EBU	0.203	5.2	CM	Best	NC3FXX, NC3MXX	ZD06-color	
Analog Audio	Balanced or Unbalanced	22-1P-EZ	22 AWG 1 Pair twisted shielded Low Capacitance Broadcast Audio	0.142	3.6	CMR	Better	NC3FXX, NC3MXX	ZD06-color	
Analog Audio	Balanced or Unbalanced	22-2C-SH	22 AWG 1 Pair twisted shielded general purpose	0.141	3.6	CMR	Good	NC3FXX, NC3MXX	ZD06-color	
Digital or Analog Audio	Unbalanced (Coaxial)	18-CMR-SD	RG6/U High Definition Serial Digital Coaxial Cable	0.272	6.9	CMR	Best	N/A	CM-RG6L series	112957
Digital or Analog Audio	Unbalanced (Coaxial)	20-CMR-VIDEO	RG59/U High Definition Serial Digital Coaxial Cable	0.236	6.0	CMR	Better	N/A	CM-RG59M series	112951
Digital or Analog Audio	Unbalanced (Coaxial)	23-MINI-SD	Mini RG59/U 23 AWG High Definition Serial Digital Coaxial Cable	0.164	4.2	CM	Best		CM-RGB23 series	112955
Digital Audio	Balanced (AES/EBU)	24-1P-DIG-AUD	24 AWG 1 Pair twisted shielded ultra-low capacitance AES/EBU	0.203	5.2	CM	Best	NC3FXX, NC3MXX	ZD06-color	
Control										
Universal Control	AMX/CRESTRON	LJNXX-U	Ultralow Capacitance 105Ω twisted shielded pair with 18/2 power	0.246	6.2	CM	Best	OEM specific		
General Control	RS232-RS485	24-2P-485	24 AWG 2 Pair twisted double shielded ultra-low capacitance 120Ω	0.326	8.3	CM	Best	NC5MXX, NC5FXX		
General Control	RS-232 Control	24-4P-SH-LIBII	Low Capacitance 24/4P stranded shielded control/data cable	0.210	5.3	CM	Good	DB9M, DB9F		
DATA										
Non LAN Data	RS232-RS485	24-2P-485	24 AWG 2 Pair twisted double shielded low capacitance 120Ω	0.326	8.3	CM	Best	NC5FXX, NC5MXX		
Non LAN Data	RS-232 Control	24-4P-SH-LIBII	Low Capacitance 24/4P stranded shielded control/data cable	0.210	5.3	CM	Better	DB9M, DB9F		
LAN Data	Category 6	24-4P-L6-EN	23 AWG 4 Pair UTP Third Party verified Category 6	0.220	5.6	CMR	Best	100 011LW		
LAN Data	Category 5e	24-4P-LS-EN	24 AWG 4 Pair UTP Third Party verified Category 5e	0.197	5.0	CMR	Better	100 003B		
Fiber										



# CABLE COMMERCIAL NON-PLENUM WIRE SCHEDULE

SIGNAL	TYPE	LWC P/N	DESCRIPTION (FIXED INSTALL)	DIAMETER	RATING	GRADE	MATING CONNECTOR		
Single Mode Fiber	Riser Single Mode	*FRISM-	* = Fiber count, Suffix D = Distribution, BO = Breakout, many styles	Varies		OFNR	Best	95-200 series	
Multi Mode OM3	Riser 62.5/125 Style	*FRIMM6-	* = Fiber count, Suffix D = Distribution, BO = Breakout, many styles	Varies		OFNR	Best	95-000 series	
Multi Mode OM4	Riser 50/125 Style	*FRIMM5-	* = Fiber count, Suffix D = Distribution, BO = Breakout, many styles	Varies		OFNR	Best	95-050 series	
Laser Optimized MM	Riser 50/125 Style Laser Optimized	*FRIMM10-	* = Fiber count, Suffix D = Distribution, BO = Breakout, many styles	Varies		OFNR	Best	95-050 * -X series	
<b>Intercom</b>									
Analog Audio	Under 1000 Feet	22-1P-EZ	22 AWG 1 Pair twisted shielded Low Capacitance Broadcast Audio	0.142	3.6	CMR	Best	NC3FXX, NC3MXX	ZD06-color
Analog Audio	Under 1000 Feet	20-2C-SH	20 AWG 2 Conductor twisted shielded general purpose	0.154	3.9	CMR	Good	NC3FXX, NC3MXX	ZD06-color
Analog Audio	Over 1000 Feet	18-2C-MCSH	18 AWG 2 Conductor twisted shielded Mid-Capacitance	0.205	5.2	CMR	Best	NC3FXX, NC3MXX	
Analog Audio	Over 1000 Feet	18-2C-SH	18 AWG 2 Conductor twisted shielded general purpose	0.169	4.3	CMR	Good	NC3FXX, NC3MXX	
<b>DC Power</b>									
Remote Power Supply	Dependent wattage + distance	22-2C-GRY	22 AWG 1 Pair twisted unshielded general purpose	0.137	3.5	CMR	Good		
Remote Power Supply	Dependent wattage + distance	18-2C-GRY	18 AWG 2 Conductor twisted unshielded general purpose	0.169	4.3	CMR	Good		
<b>RF/Wireless</b>									
Low Loss 50 Ohm	Wireless Networking	RG58-CMR	19 AWG Low Loss RG58 Riser 50Ω	0.195	5.0	CMR	Best	N/A	112116
Low Loss 50 Ohm	Wireless Networking	RG8-CMR	Low Loss flexible RF400 Series Riser rated and outdoor rated	0.405	10.3	CMR	Best	N/A	112563
<b>Video</b>									
Analog Video	Composite Video	RG6-CCTV-CM	RG6/U Base Band Video Cable	0.264	6.7	CM	Best	N/A	CM-RG6L series 112957
Analog Video	Composite Video	RG59-CCTV-CM	RG59/U Base Band Video Coaxial Cable	0.242	6.1	CM	Better	N/A	CM-RG59M series 112951
Analog Video	S-Video	23-YCLL-SIAM	Mini RG59/U 23 AWG High Definition Serial Digital Coaxial Cable x 2	0.328	8.3	CM	Best	N/A	CM-RGB23 series 112955
Analog Video	S-Video	SV-25-CM	25 AWG Solid 2 Coaxial jacketed S-Video Cable (flat)	0.270	6.9	CM	Better	N/A	CM-RGB25S series MHR-BNC
Analog Video	S-Video	SV-PVC	26 AWG Stranded 2 Coaxial jacketed S-Video Cable (flat)	0.270	6.9	CL2	Good	N/A	CM-RGB26 series MHR-BNC
Analog Video	YPbPr Component and HD Component	RGB3C-20-CMR	RG59/U High Definition Serial Digital x 3 Conductor jacketed	0.630	16.0	CMR	Best	N/A	CM-RG59M series 112951
Analog Video	YPbPr Component and HD Component	RGB3C-23-CM	Mini RG59/U High Definition Serial Digital Coaxial Cable x 3 Jacketed	0.415	10.5	CM	Better	N/A	CM-RGB23 series 112955
Analog Video	YPbPr Component and HD Component	RGB3-MINI	Mini RG59/U base band Coaxial Cable x 3 Jacketed	0.401	10.2	CMR	Good	N/A	CM-RGB25S series 112955
Analog Video	RGBHV Video non-ID/DDC Compliant	RGB5C-25-CM	25 AWG Solid 5 Coaxial jacketed RGBHV Cable	0.350	8.9	CM	Best	N/A	CM-RGB25S series MHR-BNC
Analog Video	RGBHV Video non-ID/DDC Compliant	RGB5-MINI	Mini RG59/U base band Coaxial Cable x 5 Jacketed	0.500	12.7	CMR	Better	N/A	CM-RGB25 series 112955
Analog Video	RGBHV Video non-ID/DDC Compliant	RGB5C-PVC	26 AWG Stranded 5 Coaxial jacketed RGBHV Cable	0.350	8.9	CL2	Good	N/A	CM-RGB26 series MHR-BNC
Analog Video	RGBHV Video ID/DDC Compliant	RGB6C/22-2P	26 AWG G stranded 6 Coaxial plus 2 pair control	0.410	10.4	CL2	Best	N/A	CM-RGB26 series MHR-BNC
Analog Video	Low Skew UTP	TRUPHASE	23 AWG 4 Pair UTP Low Skew Video Cable	0.205	5.2	CMR	Best	100 011LW	N/A
Analog Video	CATV	RG6-CM	RG6/U CCS Dual Shield CATV 3.0 GHz	0.272	6.9	CM	Best	N/A	CM-RG6L series 112957
Digital Video	CATV/DBS/Broadband	QUADFLEX-BC	RG6/U Quad Shield Bare Copper CATV 3.0 GHz	0.287	7.3	CM	Best	N/A	CM-RG6L series 112957
Digital Video	SMPT Standards	18-CMR-SD	RG6/U High Definition Serial Digital Coaxial Cable	0.272	6.9	CMR	Best	N/A	CM-RG6L series 112957
Digital Video	SMPT Standards	20-CMR-VIDEO	RG59/U High Definition Serial Digital Coaxial Cable	0.236	6.0	CMR	Better	N/A	CM-RG59M series 112951
<b>Voice/Phone</b>									
Telephone/Voice	Low speed Data, telephone, DSL	24-4P-L5-EN	24 AWG 4 Pair UTP Third Party verified Category 5e	0.197	5.0	CMR	Best	100 003B	N/A
Telephone/Voice	Low speed Data, telephone, DSL	24-2P-L3	24 AWG 2 Pair UTP Third Party verified Category 3	0.150	3.8	CMR	Better	100 026LW	
Telephone/Voice	Low speed Data, telephone, DSL	22-4C-50-HT	22 AWG 4 Conductor Solid Station wire	0.152	3.9	CMG	Good		
<b>Security</b>									
Camera	Pan-Tilt-Zoom (PTZ) Applications	RG59CM-18-2C	Baseband RG59/U siamesed with 18/2C Control/Power (Flat)	0.468	11.9	CM	Best	N/A	CM-RG59M series 112951
Sensor/General	DC Power, Sensor, System	22-4C	22 AWG 4 Conductor twisted unshielded general purpose	0.158	4.0	CMR	Best		
<b>Speaker</b>									
Speaker	Amplified Audio	12-2C-GRY	12 AWG 2 Conductor twisted unshielded Riser	0.274	7.0	CL3R	Best		CM-A-12
Speaker	Amplified Audio	14-2C-GRY	14 AWG 2 Conductor twisted unshielded Riser	0.230	5.8	CL3R	Best		CM-A-14
Speaker	Amplified Audio	16-2C-GRY	16 AWG 2 Conductor twisted unshielded Riser	0.183	4.6	CMR	Best		CM-A-16
Speaker	Amplified Audio	18-2C-GRY	18 AWG 2 Conductor twisted unshielded Riser	0.160	4.1	CMR	Best		CM-A-18
<b>Specialty</b>									
Multipurpose	Projector Application	RGB6C/22-2P	26 AWG stranded 6 Coaxial plus 2 pair control Jacketed	0.410	10.4	CL2	Best		CM-RGB26 series 112491-10
Multipurpose	Retrofit Applications	RGB6C-20/2LSE	20 AWG Solid 6 Coaxial+ 2 Cat5e UTP Jacketed	0.960	24.4	CMR	Best		CM-RG59M series 112951
Multipurpose	Retrofit Applications	RGB6C-23-2LSE	23 AWG Solid 6 Coaxial+ 2 Cat5e UTP Jacketed	0.627	15.9	CMG	Better		CM-RGB23 series 112955
Multipurpose	Retrofit Applications	RGB6C-25-2LSE	25 AWG Solid 6 Coaxial+ 2 Cat5e UTP Jacketed	0.533	13.5	CM	Good		CM-RGB25S series 112491-10
Multipurpose	Rack Interconnection	23-MINI-SD	Mini RG59/U 23 AWG High Definition Serial Digital Coaxial Cable	0.164	4.2	CM	Best		CM-RGB23 series 112955
Analog Audio	Microphone	24-2P-STAR-BLK	24 AWG 2 Pair Star Quad style extra flexible Mic cable	0.240	6.1	CM	Best	NC3FXX, NC3MXX	
<b>Lighting Control</b>									
Lighting Control	Lutron Systems Grafik Eye	LUTRON-GRN	22 AWG Shielded Pair+18 AWG Pair Green Stripe	0.230	5.8	CM	Best		
Lighting Control	Lutron Systems Grafik Eye 4000/5000/6000	LUTRON-RBL	22 AWG Shielded Pair+12 AWG Pair+18 AWG Sensor Blue stripe	0.300	7.6	CL3	Best		
Lighting Control	Lutron Systems Sivoia QED Control	LUTRON-RED	18 AWG Shielded Quad+18 AWG Sensor+16 AWG Pair Red Stripe	0.340	8.6	CL3	Best		
Lighting Control	Lutron Systems Keypad	LUTRON-YEL	22 AWG Shielded Pair + 18 AWG Pair Yellow Stripe	0.230	5.8	CM	Best		
Lighting Control	Lutron System EcoSystem™ Bus Cable	LUTRON-EBC	16 AWG 1 Pair twisted unshielded White jacket (Dual AWM 600V rating)	0.283	7.2	CM	Best		
Lighting Control	Lutron System EcoSystem™ Sensor Cable	LUTRON-ESC	22 AWG 5 Conductor twisted shielded white jacket (Dual AWM 600V rating)	0.293	7.4	CM	Best		
Lighting Control	DMX Control	24-2P-485	24 AWG 2 Pair twisted double shielded low capacitance 120Ω	0.326	8.3	CM	Best	NC5MXX, NC5FXX	
<b>Coax Connectors</b>									
Compression Style	C-Tec2 Mini High Resolution 25 AWG Solid	CM-RGB25S-xxx	Nickel Plated RCA, Nickel Plated BNC, and Gold Plated RCA						
Compression Style	ConneTec™ Mini Hi-Res 26 AWG	CM-RGB26-xxx	Nickel and Gold Plated RCA, Nickel and Gold Plated BNC						
Compression Style	C-Tec2 Mini RG59 23 AWG	CM-RGB23-xxx	Nickel Plated RCA, Nickel Plated BNC, and Gold Plated RCA						
Compression Style	C-Tec2 Universal RG59	CM-RG59M-xxx	Nickel Plated RCA, BNC, and F						
Compression Style	C-Tec2 Universal RG6 Plenum	CM-RG6M-xxx	Nickel Plated RCA, BNC, and F						
Compression Style	C-Tec2 Universal RG6 PVC	CM-RG6L-xxx	Nickel Plated RCA, BNC, and F						
Crimp Style	Liberty	MHR-BNC	4-Piece 75 Ohm Crimp BNC for 26 AWG mini Hi-Res Coaxial						
Crimp Style	Amphenol Connex	112955	3-Piece 75 Ohm Crimp BNC for 25 & 23 AWG mini Hi-Res Coaxial						
Crimp Style	Amphenol Connex	112951	3-Piece 75 Ohm Crimp BNC for RG59 Dual Shield						
Crimp Style	Amphenol Connex	112957	3-Piece 75 Ohm Crimp BNC for RG6 Dual Shield						
Solder Style	Liberty	ZD06-*	RCA Plug, Black Metal Body, Gold contacts 4mm cable						
Crimp Style	Liberty	MHR-RCA	4-Piece Crimp RCA for Mini High Res Coax (26/25 AWG)						

Contact your sales professional to obtain a complete Wire Schedule including the Commercial Non-Plenum Schedule and the Shipboard Schedule

# CABLE 75 OHM TRANSMISSION CHART



RESOLUTION	VGA 640X480				SVGA 800X600				XGA 1024X768				SXGA 1280X1024				UXGA 1600X1200				WUXGA 1920X1200			
	60 Hz	75 Hz	85 Hz	60 Hz	75 Hz	85 Hz	60 Hz	75 Hz	85 Hz	60 Hz	75 Hz	85 Hz	60 Hz	75 Hz	85 Hz	60 Hz	75 Hz	85 Hz	60 Hz	75 Hz	85 Hz	60 Hz	75 Hz	85 Hz
H refresh	31.5 KHz	39 KHz	45 KHz	38 KHz	50 KHz	54 KHz	48 KHz	50 KHz	60 Hz	64 KHz	68 KHz	80 KHz	80 KHz	91 KHz	75 KHz	94 KHz	107 KHz	75 KHz	94 KHz	105 KHz	75 KHz	93 KHz	105 KHz	
V refresh	27.6	34.6	39.2	43.2	54.0	61.2	70.8	88.5	100.3	118.0	147.5	167.1	172.8	216.0	244.8	207.4	293.8	216.0	244.8	293.8	207.4	293.8	293.8	
Distance in feet. Based upon straight -3dB (50% power loss) attenuation																								
EZ-LINX 26 AWG	93	82	77	73	65	61	57	51	48	44	39	37	36	32	30	33	30	32	32	30	33	30	33	27
Mini HI-RES 26 AWG	111	100	93	89	80	75	69	62	58	54	48	45	44	40	37	41	37	40	40	37	41	36	33	33
Mini HI-RES 25 AWG	112	100	94	90	81	76	70	63	59	55	49	47	46	41	39	42	39	41	41	39	42	37	35	35
RGB5-MINI	124	110	104	99	88	83	77	69	65	60	53	50	49	44	41	46	41	44	44	41	46	41	38	38
23-AWG SD	158	141	133	126	113	106	99	88	83	76	68	64	63	56	53	58	53	56	56	53	58	52	49	49

Signal	ANALOG BASE BAND				HDTV				RF				SMPTE/SDI								3G-SDI									
	Composite	S-Video	Y,Pb,Pr	Y,Pb,Pr	Y,Pb,Pr	DBS	CATV	DBS	259M A	259M B	259M C	259M D	334M	292M	424M	259M A	259M B	259M C	259M D	334M	292M	424M	259M A	259M B	259M C	259M D	334M	292M	424M	
Cable MHz	5.5	10	10	10	37	1000	1000	2250	143	177	270	540	720	1485	2,970	143	177	270	540	720	1485	2,970	143	177	270	540	720	1485	2,970	
EZ-LINX	206	153	153	153	79	NR	NR	NR	NR	NR	NR	NR	NR	NR	NR	NR	NR	NR	NR	NR	NR	NR	NR	NR	NR	NR	NR	NR	NR	NR
Mini HI-RES 26 AWG	216	157	157	157	86	NR	NR	NR	NR	NR	NR	NR	NR	NR	NR	NR	NR	NR	NR	NR	NR	NR	NR	NR	NR	NR	NR	NR	NR	NR
Mini HI-RES 25 AWG	251	187	187	187	96	NR	NR	NR	NR	NR	NR	NR	NR	NR	NR	NR	NR	NR	NR	NR	NR	NR	NR	NR	NR	NR	NR	NR	NR	NR
RGB5-MINI	282	209	209	209	108	NR	NR	NR	NR	NR	NR	NR	NR	NR	NR	NR	NR	NR	NR	NR	NR	NR	NR	NR	NR	NR	NR	NR	NR	NR
23-MINI-SD	313	232	232	232	137	77	77	51	986	887	718	506	438	207	147	986	887	718	506	438	207	147	986	887	718	506	438	207	147	
RGB9-CCTV	493	365	365	365	178	NR	NR	NR	NR	NR	NR	NR	NR	NR	NR	NR	NR	NR	NR	NR	NR	NR	NR	NR	NR	NR	NR	NR	NR	NR
RGB9-CATV	NR	NR	NR	NR	NR	105	105	70	NR	NR	NR	NR	NR	NR	NR	NR	NR	NR	NR	NR	NR	NR	NR	NR	NR	NR	NR	NR	NR	NR
20-CMR-VIDEO	449	333	333	333	195	102	102	67	1408	1318	1067	738	639	213	147	1408	1318	1067	738	639	213	147	1408	1318	1067	738	639	213	147	
RGB6-CCTV	622	461	461	461	232	NR	NR	NR	NR	NR	NR	NR	NR	NR	NR	NR	NR	NR	NR	NR	NR	NR	NR	NR	NR	NR	NR	NR	NR	NR
RGB6-CATV	NR	NR	NR	NR	NR	237	237	158	NR	NR	NR	NR	NR	NR	NR	NR	NR	NR	NR	NR	NR	NR	NR	NR	NR	NR	NR	NR	NR	NR
18-CMR-SD	561	416	416	416	245	130	130	86	1764	1586	1333	967	821	255	1764	1586	1333	967	821	255	1764	1586	1333	967	821	255	1764	1586	1333	967
RGB1-CCTV	879	652	652	652	374	NR	NR	NR	NR	NR	NR	NR	NR	NR	NR	NR	NR	NR	NR	NR	NR	NR	NR	NR	NR	NR	NR	NR	NR	NR
RGB1-CATV	NR	NR	NR	NR	NR	379	379	253	NR	NR	NR	NR	NR	NR	NR	NR	NR	NR	NR	NR	NR	NR	NR	NR	NR	NR	NR	NR	NR	NR
RGB1-EX-SD	825	612	612	612	372	348	348	232	2678	2407	2013	1437	1244	389	2678	2407	2013	1437	1244	389	2678	2407	2013	1437	1244	389	2678	2407	2013	1437
dB loss value	-3 dB	-3 dB	-3 dB	-3 dB	-3 dB	-15 dB	-15 dB	-15 dB	-30 dB	-30 dB	-30 dB	-30 dB	-30 dB	-30 dB	-30 dB	-30 dB	-30 dB	-30 dB	-30 dB	-30 dB	-30 dB	-30 dB	-30 dB	-30 dB	-30 dB	-30 dB	-30 dB	-30 dB	-30 dB	-30 dB

NR: Not Recommended for the application

Notes:  
 Plenum rated products will experience a slightly higher loss factor and the distance will be reduced from the value shown.  
 Multiple coax signals will develop timing issues as length increases. Use TDR matching for best performance.



**Liberty**  
WIRE & CABLE

**PREMADE CABLE**

**RUN WITH US**

## 3.5MM STEREO AUDIO CABLE FOR PERMANENT INSTALLATIONS

NON-PLENUM



### Features & Benefits:

- 3.5mm stereo male plug to 3.5mm stereo male connectivity
- Twisted, shielded low capacitance audio cable
- Molded green connector body
- NEC CM, CEC CMG FT4, RoHS Compliant

## E-3.5SM-M

### Application:

- iPod, MP3 Player, PC audio integration and connection
- Inter and intra device interconnection



AVAILABLE LENGTHS: 3 FEET, 6 FEET, 12 FEET, 25 FEET, 35 FEET, 50 FEET

## LIBERTY DUPLEX RCA AUDIO CABLE FOR PERMANENT INSTALLATIONS

NON-PLENUM



### Features & Benefits:

- Duplex RCA Plugs (male) to duplex RCA Plugs (male)
- All gold plated contact surfaces
- Molded connector body with red and white molding
- Low Capacitance twisted shielded pair audio snake cable
- NEC CM, CEC CMG FT4, RoHS Compliant

## E-2RCAM-M

### Application:

- Line level stereo unbalanced audio
- Inter and intra device audio patching and routing

AVAILABLE LENGTHS: 12 FEET, 25 FEET, 35 FEET, 50 FEET

## TACTICAL MICROPHONE AND AUDIO XLR 3-PIN MALE TO FEMALE CABLE

NON-PLENUM



### Features & Benefits:

- Neutrik brand professional audio XLR 3-pin connectors
- Liberty X-Cross Microphone super flexible cable
- Silver solder for all solder joints
- Male to female standard microphone/balanced audio formats
- NEC CM, CEC CM, RoHS Compliant

## SQ-XLRM-F

### Application:

- Tactical and stage microphone, balanced mono audio
- Also unbalanced stereo audio applications

AVAILABLE LENGTHS: 12 FEET, 25 FEET, 35 FEET, 50 FEET

## Z100 3.5MM TRS STEREO AUDIO CABLE

NON-PLENUM



### Features & Benefits:

- 3.5MM stereo plug (male) to 3.5mm stereo plug (male)
- All gold plated contact surfaces
- Green molded connector body
- Twisted pair construction with full braided copper shield
- Oxygen free copper conductors and braid shield
- Overall flexible PVC jacket
- UL AWM Listed, RoHS Compliant

## Z100AM

### Application:

- Line level stereo unbalanced audio Interconnection
- Inter and intra device audio patching and routing

AVAILABLE LENGTHS: 3 FEET, 6 FEET, 15 FEET, 25 FEET



## Z100 3.5MM TRS TO 2 RCA AUDIO CABLE

NON-PLENUM



### Features & Benefits:

- 3.5MM stereo plug (male) to duplex RCA plugs (male)
- All gold plated contact surfaces
- Molded connector bodies with green 3.5mm molding
- Left and right labels on the RCA plugs
- Dual coaxial type construction for low loss audio
- Oxygen free copper conductors and shields
- Siamese (SPT) zip construction easily separated
- UL AWM Listed, RoHS Compliant

## Z100AY

### Application:

- Line level stereo unbalanced audio Interconnection
- Inter and intra device audio patching and routing

AVAILABLE LENGTHS: 3 FEET, 6 FEET, 15 FEET, 25 FEET

## Z100 DUPLEX RCA STEREO AUDIO CABLE

NON-PLENUM



### Features & Benefits:

- Duplex RCA plugs (male) to duplex RCA plugs (male)
- All gold plated contact surfaces
- Molded connector body with left and right labels
- Dual coaxial type construction for low loss audio
- Oxygen free copper conductors and shields
- Siamese (SPT) zip construction easily separated
- UL AWM Listed, RoHS Compliant

## Z100A

### Application:

- Line level stereo unbalanced audio interconnection
- Inter and intra device audio patching and routing

AVAILABLE LENGTHS: 3 FEET, 6 FEET, 15 FEET, 25 FEET

## Z200 DUPLEX RCA AUDIO CABLE

NON-PLENUM



### Features & Benefits:

- Duplex RCA plugs (male) to duplex RCA plugs (male)
- All gold plated contact surfaces
- Molded connector body with blue and red silicone ID rings
- RG58 coaxial cable construction for low loss audio
- High stranding oxygen free copper conductors and shields
- Siamese (SPT) zip construction easily separated
- Extremely flexible soft PVC jacket
- UL AWM Listed, RoHS Compliant

## Z200A

### Application:

- Line level stereo unbalanced audio interconnection
- Inter and intra device audio patching and routing

AVAILABLE LENGTHS: 0.5 METERS, 1 METER, 2 METERS, 3 METERS

## Z200 SPECIALTY AUDIO SPLITTER CABLE RCA FEMALE TO 2 RCA MALE

NON-PLENUM



### Features & Benefits:

- Audio Y RCA female to duplex RCA male
- All gold plated contact surfaces
- Molded RCA housings
- RG58 coaxial cable construction for low loss audio
- High stranding oxygen free copper conductors and shields
- Passive splitter cable, not recommended for video purposes
- Extremely flexible soft PVC jacket

## Z200FM

### Application:

- Line Level mono audio splitting
- Subwoofer routing

AVAILABLE LENGTHS: 8 INCHES

**THE LIBERTY** **MONEY-SAVING SERVICES!**  
**EDGE** Go to [www.LibAV.com](http://www.LibAV.com) or contact your rep today to make Liberty an extension of your workforce!

## Z200 SPECIALTY AUDIO SPLITTER CABLE RCA MALE TO 2 RCA FEMALE

NON-PLENUM



### Features & Benefits:

- Audio Y RCA male to duplex RCA female
- All gold plated contact surfaces
- Molded RCA housings
- RG58 coaxial cable construction for low loss Audio
- High stranding oxygen free copper conductors and shields
- Passive splitter cable, not recommended for video purposes
- Extremely flexible soft PVC jacket

## Z200MF

### Application:

- Line Level mono audio splitting
- Subwoofer routing

AVAILABLE LENGTHS: 8 INCHES

## Z200 SPECIALTY AUDIO SPLITTER CABLE RCA MALE TO 2 RCA MALE

NON-PLENUM



### Features & Benefits:

- Audio Y RCA male to duplex RCA male
- All gold plated contact surfaces
- Molded RCA housings
- RG58 coaxial cable construction for low loss audio
- High stranding oxygen free copper conductors and shields
- Passive splitter cable, not recommended for video purposes
- Extremely flexible soft PVC jacket

## Z200MM

### Application:

- Line Level mono audio splitting
- Subwoofer routing



**INSTALLER'S CHOICE  
SNAPRAX SERIES**  
See Page: 239

AVAILABLE LENGTHS: 8 INCHES

## Z250 DUPLEX RCA AUDIO CABLE

NON-PLENUM



### Features & Benefits:

- Duplex RCA plugs (male) to duplex RCA plugs (male)
- All gold plated contact surfaces
- Audiophile metal RCA body with blue and red ID labels
- RG58 coaxial cable construction for low loss audio
- High stranding oxygen free copper conductors and shields
- Siamese (SPT) zip construction easily separated
- Extremely flexible soft PVC jacket
- UL AWM Listed, RoHS Compliant

## Z250A

### Application:

- Line level stereo unbalanced audio Interconnection
- Inter and intra device audio patching and routing

AVAILABLE LENGTHS: 0.5 METERS, 1 METER, 2 METERS, 3 METERS

## MANUFACTURED 3.5MM TRS PLENUM AUDIO CABLE

PLENUM



### Features & Benefits:

- 3.5mm tip-ring-sleeve male to male connectivity
- Silver solder
- Broadcast quality low capacitance shielded audio cable
- NEC CMP, CEC CMP FT6, RoHS Compliant

## P221P-3.5TRSM-M

### Application:

- Line level stereo unbalanced audio
- Line level mono unbalanced audio
- IR, RS-232C, instrumentation and control



**FULLY UPDATED TECH SPECS**  
For all products available online!  
[www.LibAV.com](http://www.LibAV.com)

AVAILABLE LENGTHS: 10 FEET, 15 FEET, 25 FEET, 35 FEET, 50 FEET, 75 FEET, 100 FEET

## 3.5MM TRS TO DUPLEX RCA PLENUM AUDIO CABLE

**PLENUM**



**Features & Benefits:**

- 3.5mm Tip-Ring-Sleeve male to duplex RCA male connectivity
- Silver solder
- Broadcast quality low capacitance shielded audio cable
- NEC CMP, CEC CMP FT6, RoHS Compliant

## P222P-3.5SM-2RCAM

**Application:**

- Line level stereo unbalanced audio
- Integration of mobile audio devices into L/R audio



**BARGAIN BIN  
PRICES DROP DAILY**  
[www.LibAV.com](http://www.LibAV.com)

AVAILABLE LENGTHS:

## DUPLEX RCA PLENUM AUDIO CABLE 25 FEET

**PLENUM**



**Features & Benefits:**

- Duplex RCA male to male connectivity
- Silver solder
- Two pair individually shielded audio cable
- NEC CMP, CEC CMP FT6, RoHS Compliant

## P222P-2RCAM-M

**Application:**

- Line level stereo unbalanced audio

AVAILABLE LENGTHS: DUPLEX RCA PLENUM AUDIO CABLE 25 FEET

# BETTER, STRONGER, EXPANSIVE!

Liberty's brand new expansive website has all of the complete information and tools you need to easily research and get what you need for your next profitable installation job.

**RUN WITH US**



## www.LibAV.com

- Keep all of your custom information and part numbers in a **password-protected area**
- Utilize our **Learning Center** for training videos, white papers and online product info
- Find complete, **up-to-date specs**, information and cross reference
- Check out our **super high-res product photography** & download any image you need
- Download any of our **literature** including our catalog, sell sheets & application brochures
- Find great deals on closeout items in our **Bargain Bin**, where prices drop daily
- Easily find our newest products right on the front page in our **Product Showcase**



**LIBERTY**  
AV SOLUTIONS



## VGA AND PC AUDIO WITH TRIPLEX AUDIO/VIDEO RCA COMBINATION CABLE

NON-PLENUM



### Features & Benefits:

- VGA+3.5TRS and triplex RCA audio/video male to male
- 26 AWG Stranded mini-high Resolution coaxial cables
- Full stereo audio on both channels
- VGA is Plug and Play and EDID compliant
- Durable heavy duty molding and strain relief
- NEC CL2P/CMP, CSA CMP FT6, RoHS Compliant

E-2V2AC3

### Application:

- Single faceplate support for 2 video and 2 audio channels
- Podium Single cable hookup for presentation systems

AVAILABLE LENGTHS: 6 FEET, 12 FEET, 25 FEET, 50 FEET

## Z100 TRIPLEX RCA AUDIO/VIDEO CABLE

NON-PLENUM



### Features & Benefits:

- All gold plated contact surfaces
- Economical oxygen free copper bulk cable coaxial formats
- Silver solder
- UL AWM ratings UL20276 for Class 2 device interconnection
- Triplex type construction, easy separation to customize

Z100AV

### Application:

- RCA composite video and left right RCA audio
- Device to device and device to plate interconnection
- Not for In-wall unless in conduit

AVAILABLE LENGTHS:

## Z200 TRIPLEX RCA AUDIO/VIDEO CABLE

NON-PLENUM



### Features & Benefits:

- Triplex RCA plugs (male) to triplex RCA plugs (male)
- All gold plated contact surfaces
- Molded RCA body with blue, red, yellow ID labels
- RG58 coaxial cable construction for low loss audio
- RG59 75-Ohm video coaxial cable for the yellow leg
- High stranding oxygen free copper conductors and shields
- Siamese (SPT) zip construction easily separated
- Extremely flexible soft PVC jacket
- UL AWM listed, RoHS Compliant

Z200AV

### Application:

- Stereo unbalanced audio and video interconnection
- Inter and intra device audio patching and routing



AVAILABLE LENGTHS: 0.5 METERS, 1 METER, 2 METERS

## PLENUM RATED AUDIO/VIDEO TRIPLEX RCA CABLE

PLENUM



### Features & Benefits:

- 3 RCA male to 3 RCA male connectivity
- Gold pin crimp MHR RCA plugs
- Crimp termination has better frequency response
- Red, white, yellow color coded sub-cables with boots
- 26 AWG mini-high resolution 200 MHz bandwidth coax cables
- NEC CMP/CL2P, CEC CMP FT6, RoHS Compliant

D-AV3RCAM-M

### Application:

- Audio/video triplex composite video and left/right audio
- 3 composite video feeds, S/PDIF digital audio, IR trigger

AVAILABLE LENGTHS: 35 FEET, 50 FEET

**TRIPLEX RCA PLENUM RATED COMPONENT VIDEO CABLE**

**PLENUM**



**Features & Benefits:**

- 3 RCA male to 3 RCA male connectivity
- Gold pin crimp MHR RCA plugs
- Crimp termination has better frequency response
- Red, green, blue color coded sub-cables with boots
- 26 AWG mini-high resolution 200 MHz bandwidth coax cables
- NEC CMP/CL2P, CEC CMP FT6, RoHS Compliant

**D-3RCAM-M**

**Application:**

- Y,Pb,Pr component video and HD component video
- Composite video, left/right RCA analog audio
- S-Video, InfraRed trigger, S/PDIF digital audio

AVAILABLE LENGTHS: 35 FEET, 50 FEET



# FIBER OPTIC HDMI

Reliable, time-saving design with no tedious fiber terminations & requires no costly fiber tools

**ENGINEERED FOR INSTALLERS**

The Celerity Detachable Fiber Optic connector supports a thin, durable fiber optic cable in multiple lengths to 1000'. The fiber optics are pre-terminated with a miniature plug (9mm width) which supports fiber optic transfer to and from HDMI.

The use of the miniature plug eliminates the need for time-consuming fiber terminations and the need for costly fiber optic tools. The miniature fiber optic plug securely connects to the Celerity Detachable HDMI connector at the source and display components.

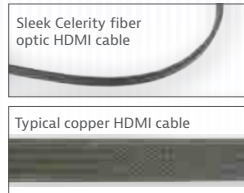

**SEE PAGE 105**  
**DFO-1000P**



Sleek cable and supports up to 1,000' without loss of signal integrity and HDMI specification

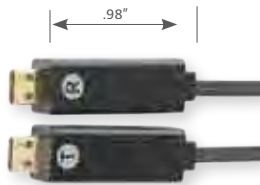

Miniature plug protects the fiber optics & internal electronics and allows for a simple and secure connection



Detachable HDMI connector makes pre-wiring of the fiber optic cable as easy as plug and play



Detachable Fiber Optic HDMI Connector



## CATEGORY/LAN/DATA

“ Liberty offers Category Cable in Category 5e, 6, 6 Augmented in plenum and riser ratings with a choice of shielded and unshielded formats. Liberty’s EN series is a step above the rest with positive ACR values to 350 MHz for Category 5e and 500 MHz for Category 6. Need a good performing cable cheaper? Our HomeTrax™ was recently upgraded to CMR fire ratings and positive ACR to 200 MHz for Category 5e and 300 MHz for Category 6. That’s better than most others 350 and 550 MHz offerings on the market. The higher frequency threshold the ACR stays above zero – the better the cable. ”



### LAN SOLUTIONS CATEGORY 5E U/UTP PRE-MADE PATCH CABLE

#### NON-PLENUM



#### Features & Benefits:

- RJ45 8P8C plug (male) to RJ45 8P8C plug (male) connectivity
- Strain relief boots per ANSI/TIA-568 requirements
- U/UTP stranded patch cable
- UL Listed AWM, ANSI/TIA-568 Category 5e compliant
- Other lengths available upon request at a premium

#### PCESB

#### Application:

- LAN 10/100/1000BaseT ethernet patching, balun support
- OEM systems device interconnection, touch panels
- IP control, voice, voice over IP, video



#### CATEGORY CABLE

Options for any type of professional installation  
See Page: 17

AVAILABLE LENGTHS:  
1 FOOT, 3 FEET, 5 FEET, 7 FEET, 10 FEET, 14 FEET, 25 FEET

AVAILABLE JACKET COLORS: ● ● ● ● ● ● ●  
PART NUMBER COLOR ID: BLK BLU GRN GRY RED WHT YEL

### LAN SOLUTIONS CATEGORY 6 U/UTP PRE-MADE PATCH CABLE

#### NON-PLENUM



#### Features & Benefits:

- RJ45 8P8C plug (male) to RJ45 8P8C plug (male) connectivity
- Strain relief boots per ANSI/TIA-568 requirements
- U/UTP stranded patch cable
- UL Listed AWM, ANSI/TIA-568 Category 6 Compliant
- Other lengths available upon request at a premium

#### PC6B

#### Application:

- LAN 10/100/1000BaseT ethernet patching, balun support
- OEM systems device interconnection, touch panels
- IP control, voice, voice over IP, video

AVAILABLE LENGTHS:  
1 FOOT, 3 FEET, 5 FEET, 7 FEET, 10 FEET, 14 FEET, 25 FEET

AVAILABLE JACKET COLORS: ● ● ● ● ● ● ●  
PART NUMBER COLOR ID: BLK BLU GRN GRY RED WHT YEL

### LAN SOLUTIONS CATEGORY 5E U/UTP PRE-MADE PLENUM PATCH CABLE 50 FEET

#### PLENUM



#### Features & Benefits:

- RJ45 8P8C plug (male) to RJ45 8P8C plug (male) connectivity
- Strain relief boots per ANSI/TIA-568 requirements
- U/UTP stranded patch cable
- ANSI/TIA-568 Category 5e Compliant
- NEC CMP, CEC CMP FT6, RoHS Compliant
- Other lengths available upon request at a premium

#### PPCESB

#### Application:

- LAN 10/100/1000BaseT ethernet patching, balun support
- OEM systems device interconnection, touch panels
- IP control, voice, voice over IP, video

AVAILABLE LENGTHS:  
50 FEET

AVAILABLE JACKET COLORS: ● ● ● ● ● ● ●  
PART NUMBER COLOR ID: BLK BLU GRN GRY RED WHT YEL

## PREMIUM MOLDED DVI ANALOG TO 5 BNC FEMALE CABLE



### Features & Benefits:

- Male DVI plug to 5 BNC jack (female) connectivity
- 26 AWG stranded mini-high resolution coaxial cables
- 75 Ohm BNC jacks
- Durable heavy duty molding and strain relief
- NEC CL2, CSA Type AWM I/II A/B FT4, RoHS Compliant

## E-DVI/A-5BNCF

### Application:

- DVI analog only conversion to 5-wire RGBHV
- RGBHV video breakout to larger low loss coaxial cables
- Installations where RGBHV has to run through conduit

AVAILABLE LENGTHS: 1 FEET, 3 FEET, 6 FEET

## PREMIUM MOLDED DVI ANALOG TO 5 BNC MALE CABLE



### Features & Benefits:

- Male DVI plug to 5 BNC pack (male) connectivity
- 26 AWG stranded mini-high resolution coaxial cables
- 75 Ohm BNC Plugs
- Durable heavy duty molding and strain relief
- NEC CL2, CSA Type AWM I/II A/B FT4, RoHS Compliant

## E-DVI/A-5BNCM

### Application:

- DVI analog only conversion to 5-wire RGBHV
- RGBHV video breakout to larger low loss coaxial cables
- Installations where RGBHV has to run through conduit

AVAILABLE LENGTHS: 15 FEET

## PREMIUM MOLDED DVI ANALOG TO 5 BNC MALE CABLE



### Features & Benefits:

- DVI/A plug to DE15 (VGA) male connectivity
- UL AWM rated cabling
- Economy product, basic construction

## E-DVI/A-VGAM

### Application:

- Analog RGBHV from DVI-I output to VGA display



**COOL SPOOL SYSTEM®**  
Our exclusive reel box and hand truck means tangle-free pulls and total control  
See Page: 253

AVAILABLE LENGTHS: 1 FEET, 3 FEET, 6 FEET

## PREMIUM MOLDED DVI DIGITAL DUAL LINK CABLE

### NON-PLENUM



### Features & Benefits:

- DVI dual link digital 29pin Plugs
- 28 AWG TMDS pair construction
- Reduced DVI molding for high density bays
- UL CL2 and CSA FT4 for In-wall, RoHS Compliant
- Resolutions up to 2048x1536 QXGA supported

## E-DVIDDL

### Application:

- DVI dual link digital 29pin plugs
- 28 AWG TMDS pair construction
- Reduced DVI molding for high density bays
- UL CL2 and CSA FT4 for In-wall, RoHS Compliant
- Resolutions up to 2048x1536 QXGA supported

AVAILABLE LENGTHS: 1 METER, 2 METERS, 4 METERS, 6 METERS, 8 METERS, 10 METERS, 12 METERS, 15 METERS

## LIBERTY PREMIUM MOLDED DVI DIGITAL SINGLE LINK CABLE

NON-PLENUM



### Features & Benefits:

- DVI 1.0 single link digital connectivity (19-pin)
- 28 AWG TMD5 pair construction
- Triple shielded cable construction
- Reduced DVI molding for high density bays
- NEC CL2 and CEC FT4 for In-wall use, RoHS Compliant
- DVI 1.0 5.0 Gbps/1900x1200 WUXGA/1080p60

## E-DVIDSL

### Application:

- Video wall, computer monitor, HDTV, CAD Station
- In-wall DVI-D video routing



**HDMI MOBILE ADAPTER RING GENIUS!**

See Page: 132

AVAILABLE LENGTHS: 1 METER, 2 METER, 4 METERS, 6 METERS, 8 METERS, 10 METERS

## ECONOMY MOLDED D-SUB DB9 FEMALE TO FEMALE NULL MODEM CABLE

NON-PLENUM



### Features & Benefits:

- D-SUB DE09 jack (female) to DE09 Jack (female) connectors
- Null modem pin out
- Molded housings with thumbscrews
- UL AWM rated for non-inwall use

## E-DB9F-F-NULL

### Application:

- Interconnection and routing of RS-232 control
- Null modem format for control of remote devices
- Routing of non-TIA data using DE09 connections

AVAILABLE LENGTHS: 3 FEET, 6 FEET, 10 FEET

## ECONOMY MOLDED D-SUB DB9 MALE TO FEMALE EXTENSION CABLE

NON-PLENUM



### Features & Benefits:

- D-SUB DE09 jack (Female) to DE09 plug (male) connectors
- Straight through pin out 1-1, 2-2, etc.
- Molded housings with thumbscrews
- UL AWM rated for non-inwall use

## E-DB9F-F

### Application:

- Interconnection and routing of RS-232 control
- Extension of RS-232 cabling
- Routing of non-TIA data using DE09 connections

AVAILABLE LENGTHS: 3 FEET, 6 FEET, 10 FEET

## ECONOMY MOLDED D-SUB RS-232 AND CONTROL CABLE 6 FEET

NON-PLENUM



### Features & Benefits:

- D-SUB DE09 jack (female) to DE09 jack (female) connectors
- Straight through pin out 1-1, 2-2, etc.
- Molded housings with thumbscrews
- UL AWM rated for non-inwall use

## E-DB9M-F

### Application:

- Interconnection and routing of RS-232 control
- Routing of non-TIA data using DE09 connections



**FULLY UPDATED TECH SPECS**  
For all products available online!

[www.LibAV.com](http://www.LibAV.com)

AVAILABLE LENGTHS: 6 FEET



## ECONOMY MOLDED TOSLINK® DIGITAL OPTICAL AUDIO CABLE



### Features & Benefits:

- EIAJ optical plug to plug (TOSLINK) connectivity
- Molded connector housings
- Polymer 1mm fiber optic core
- 655nm wavelength, attenuation less than 0.18 dB/m
- 25mm bend radius minimum
- Flexible PVC jacket
- Not UL listed, RoHS Compliant

### ZTOS

### Application:

- Digital optical audio Interconnection on consumer devices
- Inter and intra device interconnection of digital audio

AVAILABLE LENGTHS: 1 METER, 2 METERS, 4 METER, 6 METERS

## PREMIUM METAL CONNECTOR TOSLINK® DIGITAL OPTICAL AUDIO CABLE



### Features & Benefits:

- Metal EIAJ optical plug to plug (TOSLINK) connectivity
- High quality polished end face for low insertion loss
- 1mm polymer low loss optical cable
- 2.2mm polyethylene cladding
- 4mm polyvinyl chloride subjacket
- Flexible polyvinyl chloride dual layer jacket
- Cable OD 7.5mm
- Satin silver jacket finish with white connectors
- Retail packaged

### Z500NTOS

### Application:

- Optical digital audio for consumer audio devices
- Device to device interconnection of S/PDIF digital audio

AVAILABLE LENGTHS: 1 METER, 2 METERS, 4 METER, 6 METERS, 10 METERS, 15 METERS

# WebBlox® GO FROM CONCEPT TO COMPLETE PLATE DESIGN IN JUST MINUTES!

## THE PREMIER CUSTOM PLATE & PANEL DESIGN TOOL IN THE AV INDUSTRY



## PANEL CRAFTERS CUSTOM PLATES & PANELS

This free design & quoting tool gives you complete control over designing your own custom plate and panel layouts. All PanelCrafters® standard panel sizes are available. Drag-and-drop any of our standard connectors into your design, specify the text you want in WebBlox's user-friendly environment.

[CHECK IT OUT AT WWW.LIBAV.COM](http://www.libav.com)

ADD YOUR OWN LOGO | FREE SERVICE | DESIGN ONLINE, 24/7 | PASSWORD-PROTECTED ACCESS TO ALL OF YOUR DESIGNS

## Classroom Solutions

“Intelix products are ideal for K-12 education applications, including classrooms, auditoriums, learning labs, and multimedia rooms. The below drawing shows a common installation in a classroom. The focal point of the room is the interactive whiteboard, which is connected to a remote PC via an Intelix DIGI-USB2 high-speed extender. Video from a laptop and a PC are switched through an Intelix HD-4X1, and the output is transmitted to a projector via an Intelix DIGI-HD70, and the output is transmitted to a projector via an Intelix DIGI-HD70 extender set. Older analog equipment, such as a PC with a VGA output, are integrated into the system through an Intelix VGA-HD converter. ”

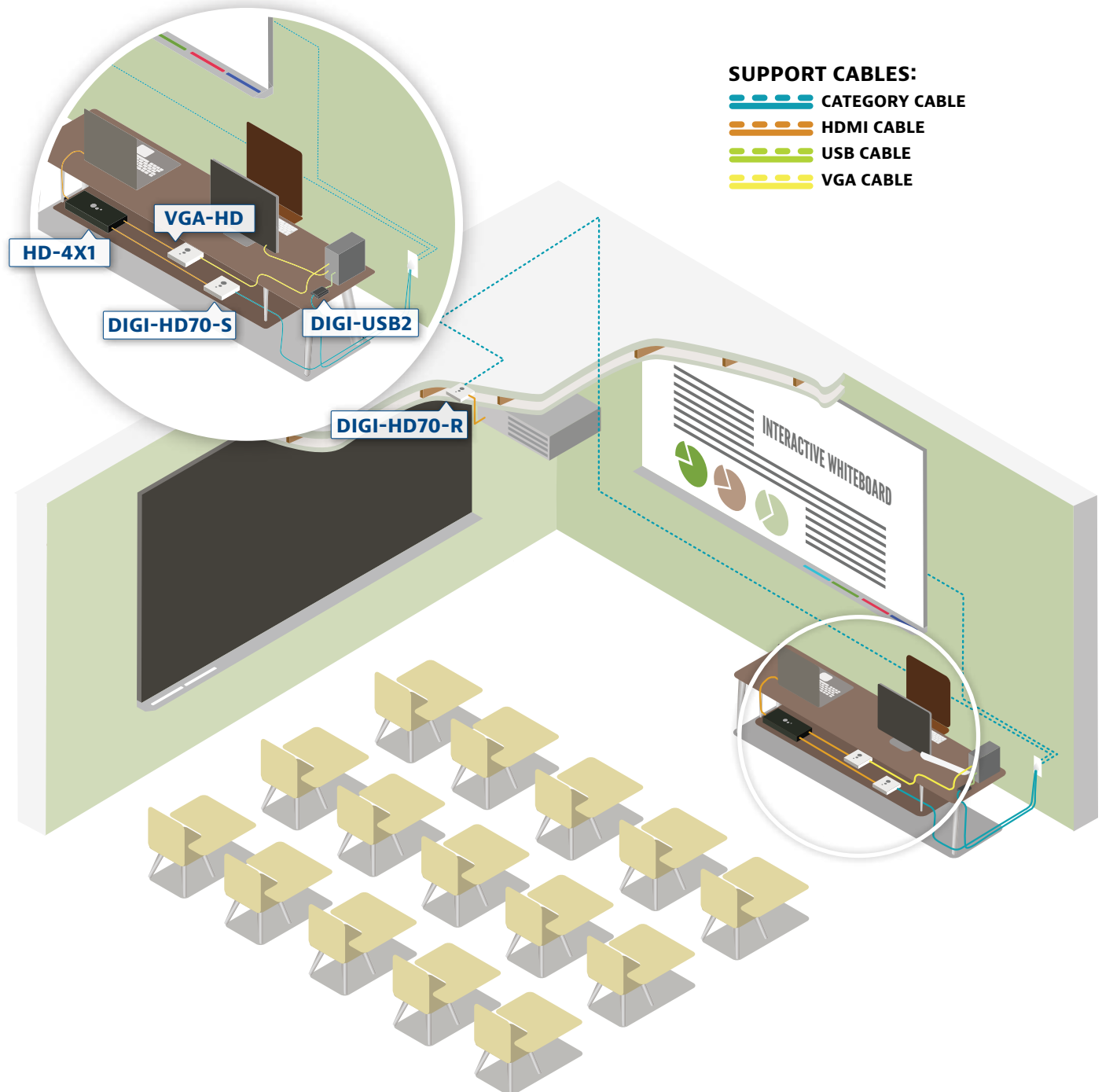

## LIBERTY EDULINX MODULAR INTERCONNECT SYSTEM MAIN UMBILICAL

NON-PLENUM



**Features & Benefits:**

- DIN 13 female to female
- 26 AWG stranded mini-high Resolution coaxial cables
- This is the main umbilical
- Durable heavy duty molding and strain relief
- NEC CL2, CSA Type AWM I/II A/B FT4, RoHS Compliant

### EZ-LINX-C1

**Application:**

- Single pull education, boardroom installations
- Quick installation component with matching faceplate
- Labor & bill of material savings in mass installs



**BARGAIN BIN!**  
**PRICES DROP DAILY**  
 Check back daily for lower prices on overstock items!  
[www.LibAV.com](http://www.LibAV.com)

AVAILABLE LENGTHS: 35 FEET, 50 FEET

## EDULINX MODULAR INTERCONNECTION SYSTEM 2 VIDEO 2 AUDIO LEAD

NON-PLENUM



**Features & Benefits:**

- DIN 13 male to VGA+3.5TRS and triplex RCA audio/video
- 26 AWG Stranded mini-high resolution coaxial cables
- Mono audio only, no stereo
- This is the lead attachment
- Durable heavy duty molding and strain relief
- NEC CL2, CSA Type AWM I/II A/B FT4, RoHS Compliant

### EZ-VGA3.53RCA-C1

**Application:**

- Single pull education, boardroom installations
- Quick Installation component with matching faceplate
- Labor & bill of material savings in mass installs

AVAILABLE LENGTHS: 3 FEET

## EDULINX MODULAR INTERCONNECTION SYSTEM VGA WITH PC AUDIO MALE LEAD

NON-PLENUM



**Features & Benefits:**

- DIN 13 male to VGA male and 3.5 TRS
- 26 AWG stranded mini-high resolution coaxial cables
- Stereo PC audio
- This is the lead attachment
- Durable heavy duty molding and strain relief
- NEC CL2, CSA Type AWM I/II A/B FT4, RoHS Compliant

### EZ-VGAMAM-C1

**Application:**

- Single pull education, boardroom installations
- Quick Installation component with matching faceplate
- Labor & bill of material savings in mass installs

AVAILABLE LENGTHS: 3 FEET

## EDULINX MODULAR INTERCONNECTION SYSTEM 2 VIDEO 2 AUDIO UMBILICAL

NON-PLENUM



**Features & Benefits:**

- DIN 13 female to VGA+3.5TRS and triplex RCA audio/video
- 26 AWG stranded mini-high resolution coaxial cables
- Mono audio only, no stereo
- This is the umbilical attachment
- Durable heavy duty molding and strain relief
- NEC CL2, CSA Type AWM I/II A/B FT4, RoHS Compliant

### EZ-VGA3.53RCA-35

**Application:**

- Single pull education, boardroom installations
- Quick Installation component with matching faceplate
- Labor & bill of material savings in mass installs



**TIE UP THE LOOSE ENDS**  
**CABLE TIES**  
 Page 258

AVAILABLE LENGTHS: 35 FEET, 50 FEET

## EDULINX MODULAR INTERCONNECT SYSTEM MAIN PLENUM UMBILICAL

**PLENUM**



**Features & Benefits:**

- DIN 13 female to female
- 26 AWG Stranded mini-high resolution coaxial cables
- This is the main umbilical
- Durable heavy duty metal construction
- NEC CL2P/CMP, CSA CMP FT6, RoHS Compliant

## EZ-LINX-P-C1

**Application:**

- Single pull education, boardroom installations
- Quick Installation component with matching faceplate
- Labor & bill of material savings in mass installs

**THE LIBERTY EDGE** **MONEY-SAVING SERVICES!**  
Go to [www.LibAV.com](http://www.LibAV.com) or contact your rep today to make Liberty an extension of your workforce!

AVAILABLE LENGTHS: 35 FEET, 50 FEET

## EDULINX MODULAR INTERCONNECTION SYSTEM 2 VIDEO 2 AUDIO PLENUM UMBILICAL

**PLENUM**



**Features & Benefits:**

- DIN 13 female to VGA+3.5TRS and triplex RCA audio/video
- 26 AWG Stranded mini-High Resolution Coaxial cables
- Mono audio only, no stereo
- This is the umbilical attachment
- Durable heavy duty metal construction
- NEC CL2, CSA Type AWM I/II A/B FT4, RoHS Compliant

## EZ-LINX-P-2V2A-35

**Application:**

- Single pull education, boardroom installations
- Quick Installation component with matching faceplate
- Labor & bill of material savings in mass installs

AVAILABLE LENGTHS: 35 FEET, 50 FEET

## EZ-LINX / EDULINX IN-LINE COUPLER

**NON-PLENUM**



**Features & Benefits:**

- DIN 13 male to male in-line coupler
- Black Molding, EZ-LINX and EDULINX compatible
- Threaded couplings for high security



## EZ-BARREL-MM

**Application:**

- DIN 13 male to male in-line coupler
- Black molding, EZ-LINX and EDULINX compatible
- Threaded couplings for high security

## EZ-LINX / EDULINX PULLING CAP ATTACHMENT

**NON-PLENUM**



**Features & Benefits:**

- Mating rotating cap for pulling EZ-LINX and EDULINX components
- Threads onto the female DIN13 jack
- Pulling force up to 50 lbs (22 KG)
- Durable heavy duty metal construction
- Nose spins to prevent cable twisting

## EZ-LINX-CAP

**Application:**

- Pulling EZ-LINX and EDULINX components
- Labor & bill of material savings in mass installs



**LOCKING HDMI**  
When you lose connectivity you lose business!  
See Page: 104

## LIBERTY EZ-LINX MODULAR INTERCONNECT SYSTEM VGA MALE LEAD

NON-PLENUM



**Features & Benefits:**

- DIN 13 male to VGA male
- 26 AWG stranded mini-high resolution coaxial cables
- ID/DDC compliant, does not support pin 9 EDID power
- This is the lead attachment
- Durable heavy duty molding and strain relief
- NEC CL2, CSA Type AWM I/II A/B FT4, RoHS Compliant

## EZ-VGAM

**Application:**

- Single pull education, boardroom installations
- Quick Installation component with matching faceplate
- Labor & bill of material savings in mass installs

AVAILABLE LENGTHS: 1 FOOT

## EZ-LINX MODULAR INTERCONNECT SYSTEM VGA WITH PC AUDIO MALE LEAD

NON-PLENUM



**Features & Benefits:**

- DIN 13 male to VGA male and 3.5 TRS
- 26 AWG Stranded mini-high resolution Coaxial cables
- Stereo PC Audio
- This is the lead attachment
- Durable heavy duty molding and strain relief
- NEC CL2, CSA Type AWM I/II A/B FT4, RoHS Compliant

## EZ-VGAMAM

**Application:**

- Single pull education, boardroom installations
- Quick Installation component with matching faceplate
- Labor and bill of material savings in mass installs

AVAILABLE LENGTHS: 1 FOOT

## EZ-LINX MODULAR INTERCONNECT SYSTEM MAIN PLENUM UMBILICAL

PLENUM



**Features & Benefits:**

- DIN 13 female to female
- 26 AWG Stranded mini-high resolution coaxial cables
- This is the main umbilical
- Durable heavy duty metal construction
- NEC CL2P/CMP, CSA CMP FT6, RoHS Compliant

## EZ-LINX-P-25

**Application:**

- Single pull education, boardroom installations
- Quick Installation component with matching faceplate
- Labor and bill of material savings in mass installs

AVAILABLE LENGTHS: 35 FEET, 50 FEET

## EZ-LINX MODULAR INTERCONNECT SYSTEM MAIN UMBILICAL 25 FEET

NON-PLENUM



**Features & Benefits:**

- DIN 13 female to female
- 26 AWG Stranded mini-high resolution coaxial cables
- This is the main umbilical
- Durable heavy duty molding and strain relief
- NEC CL2, CSA Type AWM I/II A/B FT4, RoHS compliant

## EZ-LINX

**Application:**

- Single pull education, boardroom installations
- Quick Installation component with matching faceplate
- Labor and bill of material savings in mass installs

AVAILABLE LENGTHS: 25 FEET, 35 FEET, 50 FEET, 75 FEET

## PREMIUM MODULAR INTERCONNECTION SYSTEM EDID COMPLIANT VGA FEMALE LEAD

NON-PLENUM



**Features & Benefits:**

- DIN 15 male to VGA female
- 26 AWG Stranded mini-high resolution coaxial cables
- Pin 9 EDID compliant
- This is the lead attachment
- Durable heavy duty molding and strain relief
- NEC CL2, CSA Type AWM I/II A/B FT4, RoHS Compliant

### EZ2-VF

**Application:**

- Single pull education, boardroom installations
- Quick Installation component with matching faceplate
- Labor and bill of material savings in mass installs

AVAILABLE LENGTHS: 3 FEET

## PREMIUM MODULAR INTERCONNECTION SYSTEM 2 VIDEO 2 AUDIO LEAD

NON-PLENUM



**Features & Benefits:**

- DIN 15 male to VGA+3.5TRS and Triplex RCA audio/video
- 26 AWG stranded mini-high resolution coaxial cables
- Full stereo audio on both channels
- This is the lead attachment
- Durable heavy duty molding and strain relief
- NEC CL2, CSA Type AWM I/II A/B FT4, RoHS Compliant

### EZ2-2V2A

**Application:**

- Single pull education, boardroom installations
- Quick Installation component with matching faceplate
- Labor and bill of material savings in mass installs



**FIBER OPTIC SOLUTIONS**  
Page 193

AVAILABLE LENGTHS: 3 FEET

## PREMIUM MODULAR INTERCONNECTION SYSTEM VGA & PC STEREO AUDIO UMBILICAL

NON-PLENUM



**Features & Benefits:**

- DIN 15 female to VGA+3.5TRS stereo audio
- 26 AWG stranded mini-high resolution coaxial cables
- Full stereo audio
- This is the umbilical attachment
- Durable heavy duty molding and strain relief
- NEC CL2, CSA Type AWM I/II A/B FT4, RoHS Compliant

### EZ2-VAM

**Application:**

- Single pull education, boardroom installations
- Quick Installation component with matching faceplate
- Labor and bill of material savings in mass installs

AVAILABLE LENGTHS: 3 FEET

## PREMIUM MODULAR INTERCONNECTION SYSTEM 2 VIDEO 2 AUDIO UMBILICAL

PLENUM



**Features & Benefits:**

- DIN 15 female to VGA+3.5TRS and Triplex RCA audio/video
- 26 AWG stranded mini-high resolution coaxial cables
- Full stereo audio on both channels
- This is the umbilical attachment
- Durable heavy duty molding and strain relief
- NEC CL2P/CMP, CSA CMP FT6, RoHS Compliant

### EZ2-2V2A-P

**Application:**

- Single pull education, boardroom installations
- Quick Installation component with matching faceplate
- Labor and bill of material savings in mass installs

AVAILABLE LENGTHS: 35 FEET, 50 FEET

## PREMIUM MODULAR INTERCONNECTION SYSTEM EDID COMPLIANT VGA MALE LEAD

NON-PLENUM



### Features & Benefits:

- DIN 15 male to VGA male
- 26 AWG Stranded mini-high resolution coaxial cables
- Pin 9 EDID compliant
- This is the lead attachment
- Durable heavy duty molding and strain relief
- NEC CL2, CSA Type AWM I/II A/B FT4, RoHS compliant

EZ2-VM

### Application:

- Single pull education, boardroom installations
- Quick Installation component with matching faceplate
- Labor and bill of material savings in mass installs

AVAILABLE LENGTHS: 3 FEET

## PREMIUM MODULAR INTERCONNECTION SYSTEM MAIN PLENUM RATED UMBILICAL

PLENUM



### Features & Benefits:

- DIN 15 female to female
- 26 AWG Stranded mini-high resolution coaxial cables
- This is the main umbilical
- Durable heavy duty molding and strain relief
- NEC CL2P/CMP, CSA CMP FT6, RoHS Compliant

EZ2-FF-P

### Application:

- Single pull education, boardroom installations
- Quick Installation component with matching faceplate
- Labor and bill of material savings in mass installs

AVAILABLE LENGTHS: 35 FEET, 50 FEET

# PROJECT STAGING & CUSTOM KITTING

## STREAMLINE YOUR INSTALLS AND SAVE LABOR!



### CUSTOM KITTING

Streamline your installs with a pre-packaged kit, and reduce multiple shipments to a single manageable delivery.



### PROJECT STAGING

Off-site staging program that stages, labels, and palletizes your individual project needs with any product. Ships complete to your site, increasing your efficiencies.

## THE LIBERTY EDGE

### TIE OUR PRODUCTS TO OUR SERVICES AND WE ARE UNBEATABLE!



**RUN WITH US**  
www.LibAV.com | 800.530.8998

## HDMI

“ Liberty has one of the most extensive HDMI cable offerings in the marketplace. Liberty’s HDMI cables offer some of the best shielding in the industry under that plain black wrapper. Besides our standard HDMI cable offering, we now offer locking HDMI technology and fiber HDMI. Our HD Termination System offers an installer the ability to create custom cable lengths and meet any field application that a pre-made HDMI cable won’t fit. ”



### DIGITALINX™ HOME THEATER GRADE HIGH SPEED HDMI® CABLE

NON-PLENUM



#### Features & Benefits:

- Gold plated contact surfaces
- Full metal hoods
- 28 AWG triple shielded cable
- Aesthetically pleasing polypro mesh netting - black/violet
- High speed HDMI ATC certified product
- 4Kx2K, 3D, Deep Color, all audio formats, CEC, ARC
- Supports audio return
- Retail packaging - bundt cake type insert/box

### DLX-HDSM

#### Application:

- HDMI audio and video digital Media transmission
- Home theater grade product



AVAILABLE LENGTHS: 1 METER, 2 METERS, 3 METERS

### LIBERTY HIGH SPEED HDMI® WITH ETHERNET CABLE

NON-PLENUM



#### Features & Benefits:

- HDMI "A" male to HDMI "A" male connectivity
- 30 AWG TMDS pair construction
- Triple shielded cable construction
- Maroon molding and black cable
- NEC CL2 and CEC FT4 for in-wall use, RoHS Compliant
- Third party ATC certified HDMI® high speed with ethernet
- 10.2 Gbps / 4Kx2K / 3D / Audio Return / CEC / Ethernet

### E-HDSEM-M

#### Application:

- HDMI digital multimedia device Interconnection
- In-wall routing of HDMI cables
- Rack patching HDMI equipment
- Inter and intra device Interconnection



**WIRELESS HDMI**  
Send signals through walls!  
**SKYPLAY-HD**  
See Page: 149

AVAILABLE LENGTHS: -0.5 METER, 1 METER, 1.5 METERS, 2 METER, 2.5 METERS, 3 METERS, 4 METERS, 5 METERS, 6 METERS, 8 METERS, 10 METERS, 12 METERS, 15 METERS, 20 METERS

### HIGH SPEED HDMI® WITH ETHERNET CABLE

NON-PLENUM



#### Features & Benefits:

- HDMI "A" male to DVI-D male single link connectivity
- 28 AWG TMDS pair construction
- Triple shielded cable construction
- Reduced DVI molding for high density bays
- NEC CL2 and CEC FT4 for In-wall use, RoHS compliant
- DVI 1.0 5.0 Gbps / 1900x1200 WUXGA / 1080p60

### E-HD-DVI

#### Application:

- Interconnection of HDMI video to DVI sinks (displays)
- Interconnection of DVI video to HDMI sinks (displays)
- In-wall listed per UL444, UL13 and the NEC



**HDMI MOBILE ADAPTER RING**  
GENIUS!  
See Page: 132

AVAILABLE LENGTHS: 1 METER, 2 METERS, 3 METERS, 4 METERS, 5 METERS, 6 METERS, 8 METERS, 10 METERS, 12 METERS, 15 METERS



**STANDARD HDMI® WITH ETHERNET CABLE**

NON-PLENUM



**Features & Benefits:**

- HDMI "A" male to HDMI "A" male connectivity
- Triple shielded cable construction
- Black molding and cable
- NEC CL2 and CEC FT4 for In-wall use, RoHS Compliant
- Third party ATC certified HDMI(R) high speed with ethernet
- 2.25 Gbps / 1080p24 / Audio Return / CEC / Ethernet

**E-HDM-M**

**Application:**

- HDMI digital multimedia device interconnection
- In-wall routing of HDMI cables
- Rack patching HDMI equipment
- Inter and intra device interconnection

AVAILABLE LENGTHS: 0.5 METER, 1 METER, 2 METERS, 3 METERS, 4 METERS, 5 METERS, 6 METERS, 8 METERS, 10 METERS, 12 METERS, 15 METERS, 20 METERS, 25 METERS, 30 METERS, 35 METERS

**MICRO MOLDED LOW PROFILE HIGH SPEED HDMI(R) WITH ETHERNET CABLES**

NON-PLENUM



**Features & Benefits:**

- HDMI "A" Male to "A" Male Connectivity
- All Gold Plated Contact Surfaces
- Ultra small flexible diameter cable 3.6mm
- 36 AWG TMDS Pair Construction
- 2m and longer have RedMere Active chipsets for equalization and boost
- Dual Layer Foil and High % Braid shielding
- Flexible Polyvinyl Chloride Jacket
- AWM rating, RoHS Compliant
- Third Party ATC Certified HDMI® High Speed w/ ethernet
- 10.2 Gbps / 4Kx2K / 3D / CEC
- All HDMI Audio formats supported

**E-MHDM-M**

**Application:**

- HDMI Digital Multimedia Device Interconnection
- Rack patching HDMI equipment
- Inter and Intra device Interconnection

AVAILABLE LENGTHS: 0.5 METER, 1 METER, 1.5 METERS, 2 METERS, 3 METERS, 4 METERS

**DIGITALINX™**

# HDMI ADAPTER RING

Keep your adapters where they need to be and immediately accessible for your mobile content presentation podium, boardroom, or docking station!

**PERFECR FOR:**

- Adapting various mobile content devices to HDMI
- Interfacing Laptops, Macs, iPad, Smartphone to HDMI



HDMI CABLE CLAMP (CABLE NOT INCLUDED)

- Larger foam rubber insert is for standard HDMI cables from 6 to 10mm in diameter
- Smaller foam rubber insert is for the newer micro sized HDMI cables from 3 to 5mm in diameter

The Digitalinx™ Adapter Ring is your solution to keep those mobile content adapters secure and safe in your presentation applications. The DL-AR is a simple locking loop of security cable combined with a neat faux ferrite bead cable clamp and specialized eyelet molded adapters for adapting various mobile content devices to your existing HDMI infrastructure.

Easily modifiable and repairable, this system can have more adapters added or ones you don't use removed.

**DL-AR** SEE PAGE 132



# LOCKING HDMI

Get perfect connectivity with PerfectPath's patented HDMI cables!



Winner of the 2009 Best Interconnect Device from Insight Media, PerfectPath cables continue to receive rave reviews from users across audiences, including installers, gamers and HDTV owners.



## LOCKING HIGH SPEED HDMI WITH ETHERNET CABLE

NON-PLENUM



### Features & Benefits:

- HDMI "A" male to "A" male connectivity
- All gold plated contact surfaces
- 25Lb retention patented locking connector technology
- 28 AWG TMDS pairs
- Built in equalizer/booster circuit
- FR-PVC, flame rated flexible polyvinyl chloride jacket
- NEC CL2, CSA CMG FT4, RoHS Compliant
- Third party ATC Certified HDMI High Speed w/ethernet
- 10.2 Gbps / 4Kx2K / 3D / Audio Return / CEC / Ethernet
- All HDMI Audio formats supported

## HD-1000

### Application:

- HDMI digital multimedia integration and interconnection
- Home theater HDMI connection
- Inter and intra device HDMI interconnection



AVAILABLE LENGTHS: 2 FEET, 4 FEET, 8 FEET, 16 FEET, 25 FEET, 35, FEET, 50 FEET

## LOCKING HIGH SPEED HDMI® WITH AUDIO RETURN CABLE

NON-PLENUM



### Features & Benefits:

- HDMI "A" male to "A" male connectivity
- All gold plated contact surfaces
- 25Lb retention patented locking connector technology
- 28 AWG TMDS pairs
- Built in equalizer/booster circuit
- FR-PVC, flame rated flexible polyvinyl chloride jacket
- NEC CL2, CSA CMG FT4, RoHS Compliant
- Third party ATC certified HDMI high speed
- 10.2 Gbps / 4Kx2K / 3D / Audio Return / CEC
- All HDMI Audio formats supported

## HD-700

### Application:

- HDMI digital multimedia integration and interconnection
- Home theater HDMI connection
- Inter and intra device HDMI interconnection



AVAILABLE LENGTHS: 2 FEET, 4 FEET, 8 FEET, 16 FEET, 25 FEET, 35, FEET, 50 FEET

## HIGH RETENTION HIGH SPEED HDMI® WITH WITH ETHERNET CABLE

NON-PLENUM



### Features & Benefits:

- HDMI "A" Male to "A" Male Connectivity
- All Gold Plated Contact Surfaces
- 12Lb retention patented locking connector technology
- 28 AWG TMDS pairs
- FR-PVC, flame rated flexible polyvinyl chloride jacket
- NEC CL2, CSA CMG FT4, RoHS Compliant
- Third party ATC Certified HDMI High Speed w/ethernet
- 10.2 Gbps / 4Kx2K / 3D / Audio Return / CEC
- All HDMI audio formats supported

## HD-600

### Application:

- HDMI digital multimedia integration and interconnection
- Home theater HDMI connection
- Inter and intra device HDMI interconnection



AVAILABLE LENGTHS: 3 FEET, 6 FEET, 12 FEET

## STANDARD HDMI® WITH ETHERNET CABLE

**PLENUM**



### Features & Benefits:

- Plenum rated cable for all installations
- Ultra-Small diameter cable
- Detachable HDMI TX and RX units from main body
- USB power required on the RX side of the installation
- HDMI High Speed, 10.2Gbps, 4Kx2K, 3D, all audio formats



## DFO-1000P

### Application:

- HDMI projectors, displays in commercial and residential
- Maximum bandwidth and distance needs for HDMI installs



AVAILABLE LENGTHS: 35 FEET, 40 FEET, 50 FEET, 60 FEET, 80 FEET, 100 FEET, 160 FEET, 200 FEET, 500 FEET, 1000 FEET

## PLENUM RATED HIGH SPEED HDMI® WITH ETHERNET CABLE

**PLENUM**



### Features & Benefits:

- 24 AWG construction for low loss / zero bit error signals
- Black molding
- CMP 75C Plenum rated for the US and Canada
- Gold plated contacts
- ATC Certified to 10.2 Gbps / 4K x 2K and all audio formats
- Supports CEC, Audio Return Channel (ARC), ethernet

## P-HDM-M-08

### Application:

- HDMI digital multimedia in NEC plenum regulated installs
- DVI digital video in NEC plenum regulated installs
- Backwards compatible to all non-plenum NEC applications



AVAILABLE LENGTHS: 3 METERS, 5 METERS, 6 METERS, 8 METERS

## PLENUM RATED STANDARD HDMI® WITH ETHERNET CABLE

**PLENUM**



### Features & Benefits:

- 24 AWG Construction for low loss / zero bit error signals
- Black Molding
- CMP 75C plenum rated for the US and Canada
- Gold Plated contacts
- ATC Certified to 2.25 Gbps / 1080p24 and all audio formats
- Supports Audio Return Channel (ARC), ethernet
- Supports Audio Return Channel (ARC), ethernet

## P-HDM-M-10

### Application:

- 24 AWG construction for low loss / zero bit error signals
- Black Molding
- CMP 75C plenum rated for the US and Canada
- Gold plated contacts
- ATC Certified to 2.25 Gbps / 1080p24 and all audio formats



AVAILABLE LENGTHS: 10 METERS, 12 METERS

## PLENUM RATED HD CABLE WITH ACTIVE DIRECTIONAL CHIPSETS

**PLENUM**



### Features & Benefits:

- 24 AWG Construction for low loss / zero bit error signals
- Black molding
- CMP 75C Plenum rated for the US and Canada
- Gold plated contacts
- Active equalizer and booster built into the cable
- This cable is directional, see Instructions for details
- 10.2 Gbps / 4Kx2K Video / All Audio formats
- Non-ATC certified as CEC is not supported

## P-HDM-M-15

### Application:

- HDMI Digital Multimedia in NEC plenum regulated installs
- DVI Digital Video in NEC plenum regulated installs
- Backwards compatible to all non-plenum NEC applications



AVAILABLE LENGTHS: 15 METERS, 18 METERS, 20 METERS, 23 METERS, 25 METERS, 30 METERS

# HD TERMINATION

Perfect for HDMI custom cable lengths in the field!  
**RUN WITH US**

SEE PAGE 30



- Customize your HD cable lengths to professionally dress racks and minimize excess cable
- Locking HDMI connector technology increases retention up to 400%
- Supports HDMI with ethernet, CEC and bi-directional audio formats
- Send 1080p video up to 55ft with optional extender

**TERMINATE IN 5 MINUTES!**



WATCH IT NOW!  
 HD TERMINATION



UPPER HOOD

LOWER HOOD



WHITE SLEEVE



BLACK SLEEVE



LOWER CONNECTOR SHELL (SILVER)



CONNECTOR BODY



UPPER CONNECTOR SHELL (GOLD)



RIBBON CABLE  
 DL-HDMCBL



CRIMP & CUTTING TOOL  
 DL-HDMHT



CONNECTORS & SHELLS  
 DL-HDMCPK



OPTIONAL EXTENDER  
 74-005-01

## PREMIUM MOLDED S-VIDEO MINI-DIN CABLE



### Features & Benefits:

- S-Video mini-DIN 4 pin male to male connectivity
- 26 AWG Stranded mini-high resolution coaxial cables
- Durable metal shell plugs and strain relief
- NEC CL2, CSA Type AWM I/II A/B FT4, RoHS Compliant

## E-SVM-M

### Application:

- S-Video mini-DIN 4 pin male to male connectivity
- 26 AWG Stranded mini-high resolution coaxial cables
- Durable metal shell plugs and strain relief
- NEC CL2, CSA Type AWM I/II A/B FT4, RoHS Compliant

AVAILABLE LENGTHS: 6 FEET, 12 FEET, 25 FEET

## PREMIUM MOLDED S-VIDEO MINI-DIN TO Y/C BNC FEMALE CABLE



### Features & Benefits:

- Male S-Video plug to 2 BNC jack (female) connectivity
- 26 AWG stranded mini-high resolution coaxial cables
- 75 Ohm BNC Jacks
- Durable heavy duty molding and strain relief
- NEC CL2, CSA Type AWM I/II A/B FT4, RoHS Compliant

## E-SVM-2BNCF

### Application:

- S-Video conversion to Y/C 2-wire
- Y/C Video breakout to larger low loss coaxial cables
- Installations where S-Video has to run through conduit



**WebBlox**  
CUSTOMIZE YOUR  
PLATES WITH  
PANELCRAFTERS  
[www.LibAV.com](http://www.LibAV.com)

AVAILABLE LENGTHS: 0.5 FOOT, 1 FOOT, 3 FEET

## LIBERTY PREMIUM MOLDED S-VIDEO MINI-DIN TO Y/C BNC MALE CABLE 3 FEET



### Features & Benefits:

- Male S-Video plug to 2 BNC plug (male) connectivity
- 26 AWG stranded mini-high resolution coaxial cables
- 75 Ohm BNC plugs
- Durable heavy duty molding and strain relief
- NEC CL2, CSA Type AWM I/II A/B FT4, RoHS Compliant

## E-SVM-2BNCM

### Application:

- S-Video conversion to Y/C 2-wire
- Y/C Video breakout to larger low loss coaxial cables
- Installations where S-Video has to go through conduit

AVAILABLE LENGTHS: 3 FEET, 6 FEET



# BARGAIN BIN PRICES DROP DAILY!

[www.LibAV.com](http://www.LibAV.com)

**CHECK IT OUT TODAY-  
WHEN THEY'RE GONE,  
THEY'RE GONE!**

BULK & PREMADE CABLE | CONNECTORS & ADAPTORS | INTELIX DIGITAL & ANALOG DEVICES | FIBER OPTIC SOLUTIONS  
PANELCRAFTERS PLATES & PANELS | RACKS & MOUNTS | POWER MANAGEMENT | PROFESSIONAL TOOLS & ACCESSORIES

## ECONOMY MOLDED USB 3.0 A MALE TO A MALE 15



### Features & Benefits:

- USB "A" plug (male) to "A" plug (male) connectivity
- In-Line format, no panel mount option
- Molded PVC connector housings
- USB 1.1, 2.0 and 3.0 compliant
- AWM rated cable, not for in-wall use



## E-USBAA

### Application:

- USB Patching between panels/plates and host devices
- Not to exceed 16.5 feet without active extensions



**New Website**  
[www.LibAV.com](http://www.LibAV.com)  
**BETTER, STRONGER, EXPANSIVE!**

AVAILABLE LENGTHS: 6 FEET, 15 FEET

## ECONOMY MOLDED USB 3.0 A MALE TO B MALE



### Features & Benefits:

- USB "A" male to "B" male connectivity
- Molded PVC connector housings
- USB 1.1, 2.0 and 3.0 Compliant
- AWM rated cable, not for in-wall use



## E-USBAB

### Application:

- USB connection from host to remote device
- Not to exceed 16.5 feet without active extensions

AVAILABLE LENGTHS: 3 FEET, 6 FEET, 10 FEET, 15 FEET

## USB 2.0 IN-LINE EXTENDER CABLE WITH BOOSTER



### Features & Benefits:

- USB "A" male to "A" female connectivity
- In-Line format, no panel mount option
- Active booster built in, can daisy chain 3 units
- USB 1.1 and 2.0 Compliant
- AWM rated cable, not for in-wall use



## E-USBAAEX

### Application:

- Extending USB 2.0 circuits past the 16.5 foot maximum
- Boosting a weakened signal after a passive junction.

AVAILABLE LENGTHS: 15 FEET

**THE LIBERTY LEVERAGE OUR SERVICES AS AN EXTENSION OF YOUR WORKFORCE!**  
**EDGE** Consolidate purchases, save time, labor & improve your profitability by putting the expansive Liberty Edge services to work for you! **CALL YOUR REP TODAY FOR DETAILS! 800.530.8998**



## PREMIUM MOLDED EDID COMPLIANT VGA CABLE

NON-PLENUM



### Features & Benefits:

- VGA male to male connectivity
- 26 AWG Stranded mini-high resolution coaxial cables
- Pin 9 EDID VESA power connected
- Durable heavy duty molding and strain relief
- NEC CL2, CSA Type AWM I/II A/B FT4, RoHS compliant



## E-VGAM-M

### Application:

- EDID in-wall VGA signal routing
- Flat screen, projector, video wall
- Education, boardroom, home theater

AVAILABLE LENGTHS: 3 FEET, 6 FEET, 10 FEET, 15 FEET, 25 FEET, 35 FEET, 50 FEET, 75 FEET, 100 FEET

## PREMIUM MOLDED VGA FEMALE TO 5 BNC FEMALE CABLE

NON-PLENUM



### Features & Benefits:

- Male VGA female to 5 BNC female connectivity
- 26 AWG Stranded mini-high resolution coaxial cables
- 75 Ohm BNC jacks
- Durable heavy duty molding and strain relief
- NEC CL2, CSA Type AWM I/II A/B FT4, RoHS compliant

## E-VGAF-5BNCF

### Application:

- RGBHV video breakout to larger low loss coaxial cables
- Installations where RGBHV has to run through conduit

AVAILABLE LENGTHS: 1 FOOT

## PREMIUM MOLDED VGA FEMALE TO 5 BNC MALE CABLE

NON-PLENUM



### Features & Benefits:

- Male VGA female to 5 BNC male connectivity
- 26 AWG stranded mini-high resolution coaxial cables
- 75 Ohm BNC jacks
- Durable heavy duty molding and strain relief
- NEC CL2, CSA Type AWM I/II A/B FT4, RoHS Compliant

## E-VGAF-5BNCM

### Application:

- RGBHV Video breakout to larger low loss coaxial cables
- Installations where RGBHV has to run through conduit



**FULLY UPDATED TECH SPECS**  
For all products available online!  
[www.LibAV.com](http://www.LibAV.com)

AVAILABLE LENGTHS: 3 FEET, 6 FEET

## PREMIUM MOLDED VGA MALE TO 5 BNC FEMALE CABLE

NON-PLENUM



### Features & Benefits:

- Male VGA male to 5 BNC female connectivity
- 26 AWG stranded mini-high resolution coaxial cables
- 75 Ohm BNC jacks
- Durable heavy duty molding and strain relief
- NEC CL2, CSA Type AWM I/II A/B FT4, RoHS Compliant

## E-VGAM-5BNCF

### Application:

- RGBHV Video breakout to larger low loss coaxial cables
- Installations where RGBHV has to run through conduit

AVAILABLE LENGTHS: 0.5 FOOT, 1 FOOT, 2 FEET, 3 FEET, 6 FEET, 12 FEET

## PREMIUM MOLDED VGA MALE TO 5 BNC MALE CABLE

NON-PLENUM



### Features & Benefits:

- Male VGA male to 5 BNC female connectivity
- 26 AWG stranded mini-high resolution coaxial cables
- 75 Ohm BNC plugs
- Durable heavy duty molding and strain relief
- NEC CL2, CSA Type AWM I/II A/B FT4, RoHS Compliant

## E-VGAM-5BNCM

### Application:

- RGBHV Video breakout to larger low loss coaxial cables
- Installations where RGBHV has to go through conduit



AVAILABLE LENGTHS: 1 FOOT, 3 FEET, 6 FEET, 10 FEET, 15 FEET, 25 FEET

## LIBERTY PREMIUM MOLDED VGA WITH PC STEREO AUDIO CABLE

NON-PLENUM



### Features & Benefits:

- VGA and 3.5 TRS male to male connectivity
- 26 AWG stranded mini-high resolution coaxial cables
- 3.5mm Stereo plugs molded in green per standard
- ID Bit communications and EDID Pin 9 on 24 AWG cabling
- Full 15-Pin VESA EDID and ID/DDC compliance
- Durable heavy duty molding and strain relief
- NEC CL2, CSA Type AWM I/II A/B FT4, RoHS Compliant

## E-VGAMAM-M

### Application:

- EDID in-wall VGA with audio signal routing
- Flat screen, projector, with audio installations
- Education, boardroom, home theater

AVAILABLE LENGTHS: 3 FEET, 6 FEET, 12 FEET, 15 FEET, 25 FEET, 35 FEET, 50 FEET

## Z100 VGA AND 3.5TRS PC STEREO AUDIO CABLE

NON-PLENUM



### Features & Benefits:

- DE15 male plug to DE15 male plug video connectivity
- 3.5mm male plug to 3.5mm male plug stereo audio
- Video and sync on 28 AWG high resolution coaxial cables
- ID Bit communications and EDID Pin 9 on 24 AWG cabling
- Full 15-Pin VESA EDID and ID/DDC compliance
- Double shielded foil and braid overall shield
- Ferrite Beads for EMI Compliance
- 22 inch Audio leads for routing ease & convenience
- AWM 20276, CSA Type AWM I/II A/B FT4, RoHS Compliant

## Z100VGAA

### Application:

- RGBHV Video with audio, VGA 640x480 up to WUXGA 1920x1200
- Routing of RGBHV Video in non-NEC regulated installations
- Inter and intra device interconnection

AVAILABLE LENGTHS: 15 FEET

## Z100 VGA CABLE

NON-PLENUM



### Features & Benefits:

- DE15 Male Plug to DE15 male plug connectivity
- Video and Sync on 28 AWG high resolution coaxial cables
- ID Bit communications and EDID Pin 9 on 24 AWG cabling
- Full 15-Pin VESA EDID and ID/DDC Compliance
- Double Shielded foil and braid overall shield
- Ferrite beads for EMI Compliance
- Thumbscrew for ease of installation and retention
- All Gold Plated Contact Surfaces
- UL AWM 20276, CSA Type AWM I/II A/B FT4, RoHS Compliant

## Z100VGA

### Application:

- RGBHV Video, VGA 640x480 up to WUXGA 1920x1200
- Routing of RGBHV video in non-NEC regulated installations
- Inter and intra device interconnection

AVAILABLE LENGTHS: 3 FEET, 6 FEET, 15 FEET, 25 FEET, 35 FEET, 50 FEET



## VGA AND 3.5TRS STEREO AUDIO PLENUM CABLE

**PLENUM**



**Features & Benefits:**

- VGA and 3.5 TRS male to male connectivity
- 26 AWG stranded mini-high resolution coaxial cables
- ID/DDC plug and play
- Full stereo audio
- Durable heavy duty metal construction
- NEC CL2P/CMP, CSA CMP FT6, RoHS Compliant

## G-VGAMAM-M

**Application:**

- Plenum VGA with audio signal routing
- Flat screen, projector, with audio installations
- Education, boardroom, home theater

AVAILABLE LENGTHS: 25 FEET, 35 FEET, 50 FEET, 75 FEET

## VGA MALE TO FEMALE PLENUM EXTENSION CABLE

**PLENUM**



**Features & Benefits:**

- VGA male to female connectivity
- 26 AWG stranded mini-high resolution coaxial cables
- Full EDID and plug and Play, pin 9 connected
- Durable heavy duty metal construction
- NEC CL2P/CMP, CSA CMP FT6, RoHS Compliant

## G-VGAM-F

**Application:**

- Plenum VGA signal extension
- Flat screen, projector, with audio installations
- Education, boardroom, home theater



**BARGAIN BIN!**  
**PRICES DROP DAILY**  
Check back daily for lower prices on overstock items!  
[www.LibAV.com](http://www.LibAV.com)

AVAILABLE LENGTHS: 50 FEET

## VGA MALE TO MALE PLENUM CABLE

**PLENUM**



**Features & Benefits:**

- VGA male to male connectivity
- 26 AWG stranded mini-high resolution coaxial cables
- Full EDID and plug and play, pin 9 connected
- Durable heavy duty metal construction
- NEC CL2P/CMP, CSA CMP FT6, RoHS Compliant

## G-VGAM-M

**Application:**

- Plenum VGA signal routing
- Flat screen, projector, with audio installations
- Education, boardroom, home theater

AVAILABLE LENGTHS: 35 FEET, 50 FEET

## VGA+3.5TRS AND TRIPLEX RCA AUDIO/VIDEO PLENUM CABLE

**PLENUM**



**Features & Benefits:**

- VGA male to male connectivity
- 26 AWG Stranded mini-high resolution coaxial cables
- Durable heavy duty molding and strain relief
- NEC CLz2, CSA Type AWM I/II A/B FT4, RoHS Compliant

## G-2V2A-B1

**Application:**

- EDID in-wall VGA signal routing
- Flat screen, projector, Video wall
- Education, boardroom, home theater

AVAILABLE LENGTHS: 3 FEET, 6 FEET, 10 FEET, 15 FEET, 25 FEET, 35 FEET, 50 FEET, 75 FEET, 100 FEET

## VGA+3.5TRS AND TRIPLEX RCA AUDIO/VIDEO PLENUM CABLE

### PLENUM



#### Features & Benefits:

- VGA+3.5TRS and Triplex RCA audio/video male to male
- 26 AWG Stranded mini-high resolution coaxial cables
- Full stereo audio on both channels
- VGA is not EDID or plug and play
- One VGA has a 45 degree lateral exit hood
- Durable heavy duty metal construction
- NEC CL2P/CMP, CSA CMP FT6, RoHS Compliant

## G-2V2A-C3-45DEG

#### Application:

- Single faceplate support for 2 video and 2 audio channels
- Single pull education, boardroom installations
- Quick Installation component with matching faceplate
- Labor and bill of material savings in mass installs

AVAILABLE LENGTHS: 50 FEET

## MICRO VGA CABLE SOLUTIONS

### Tabletop Micro NON-PLENUM



#### Features & Benefits:

- Micro-Sized Molding and Cable for small OD and flexibility
- VGA male to male connectivity
- Full 15-Pin VESA EDID and ID/DDC Compliance
- Double Shielded foil and braid overall shield
- Ferrite Beads for EMI Compliance
- Thumbscrew for ease of installation and retention
- UL AWM 20276, CSA Type AWM I/II A/B FT4, RoHS Compliant

## E-MVGAM-M

#### Application:

- RGBHV Video VGA 640x480 up to WUXGA 1920x1200
- Tabletop VGA for PC's/laptops
- Inter and intra device interconnection



**HDMI MOBILE  
ADAPTER RING  
GENIUS!**

See Page: 132

AVAILABLE LENGTHS: 3 FEET, 6 FEET, 12 FEET, 25 FEET

## MICRO VGA AND AUDIO CABLE SOLUTIONS

### Tabletop Micro NON-PLENUM



#### Features & Benefits:

- Micro-sized molding and cable for small OD and flexibility
- VGA and 3.5mm Audio male to male connectivity
- Full 15-pin VESA EDID and ID/DDC Compliance
- Double shielded foil and braid overall shield
- Ferrite beads for EMI Compliance
- Thumbscrew for ease of installation and retention
- 8 & 22 inch audio leads for routing ease and convenience
- UL AWM 20276, CSA Type AWM I/II A/B FT4, RoHS Compliant

## E-MVGAMAM-M

#### Application:

- RGBHV Video with audio, VGA 640x480 up to WUXGA 1920x1200
- Tabletop RGBHV with audio Interface for PC's/laptops
- Inter and intra device interconnection

AVAILABLE LENGTHS: 3 FEET, 6 FEET, 12 FEET, 15 FEET, 25 FEET

## MICRO VGA AND AUDIO WITH ETHERNET SINGLE CABLE SOLUTIONS

### Tabletop Micro NON-PLENUM



#### Features & Benefits:

- Micro-sized molding and cable for small OD and flexibility
- VGA, 3.5mm Audio, and RJ45 LAN male to male connectivity
- Full 15-pin VESA EDID and ID/DDC Compliance
- Double shielded foil and braid overall shield
- Ferrite beads for EMI compliance
- Thumbscrew for ease of installation and retention
- 8 & 22 inch audio leads for routing ease and convenience
- UL AWM 20276, CSA Type AWM I/II A/B FT4, RoHS Compliant

## E-MVGAANM-M

#### Application:

- RGBHV Video with audio, VGA 640x480 up to WUXGA 1920x1200
- Tabletop RGBHV with Audio Interface for PC's/laptops
- PC patching to ethernet in tabletop, podium applications
- Inter and intra device interconnection

AVAILABLE LENGTHS: 3 FEET, 6 FEET, 1.5 METERS, 2 METER

## MICRO VGA AND AUDIO WITH USB CONTROL SINGLE CABLE SOLUTIONS

**Tabletop Micro  
NON-PLENUM**



### Features & Benefits:

- Micro-sized molding and cable for small OD and flexibility
- VGA, 3.5mm Audio, and USB A to B male to male connectivity
- Full 15-Pin VESA EDID and ID/DDC Compliance
- Double Shielded foil and braid overall shield
- Ferrite Beads for EMI Compliance
- Thumbscrew for ease of installation and retention
- 8 & 22 inch audio leads for routing ease and convenience
- UL AWM 20276, CSA Type AWM I/II A/B FT4, RoHS Compliant

**E-MVGAPM-M**

### Application:

- RGBHV Video with audio, VGA 640x480 up to WUXGA 1920x1200
- Tabletop RGBHV with audio Interface for PC's/laptops
- PC Patching for USB in tabletop, podium applications
- Inter and intra device interconnection

AVAILABLE LENGTHS: 6 FEET

## MICRO VGA EXTENSION AND COUPLING CABLE

**Tabletop Micro  
NON-PLENUM**



### Features & Benefits:

- Micro-Sized Molding and Cable for small OD and flexibility
- VGA male to female connectivity
- Full 15-Pin VESA EDID and ID/DDC Compliance
- Double Shielded foil and braid overall shield
- Ferrite Beads for EMI Compliance
- Thumbscrew for ease of installation and retention
- UL AWM 20276, CSA Type AWM I/II A/B FT4, RoHS Compliant

**E-MVGAM-F**

### Application:

- Micro-Sized molding and cable for small OD and flexibility
- VGA male to female connectivity
- Full 15-Pin VESA EDID and ID/DDC Compliance
- Double Shielded foil and braid overall shield
- Ferrite Beads for EMI Compliance
- Thumbscrew for ease of installation and retention
- UL AWM 20276, CSA Type AWM I/II A/B FT4, RoHS Compliant

AVAILABLE LENGTHS: 6 FEET

# BETTER, STRONGER, EXPANSIVE!

Liberty's brand new expansive website has all of the complete information and tools you need to easily research and get what you need for your next profitable installation job.

**RUN WITH US**



**www.LibAV.com**

- Keep all of your custom information and part numbers in a **password-protected area**
- Utilize our **Learning Center** for training videos, white papers and online product info
- Find complete, **up-to-date specs**, information and cross reference
- Check out our **super high-res product photography** & download any image you need
- Download any of our **literature** including our catalog, sell sheets & application brochures
- Find great deals on closeout items in our **Bargain Bin**, where prices drop daily
- Easily find our newest products right on the front page in our **Product Showcase**



**LIBERTY**  
AV SOLUTIONS



## HIGH RESOLUTION RCA MALE TO RCA MALE COMPOSITE VIDEO CABLE

NON-PLENUM



### Features & Benefits:

- RCA plug (male) to RCA plug (male) connectivity
- All gold plated contact surfaces
- Black metal connector body
- Serial digital dual shield RG59 size coaxial cable
- NEC CMR, CEC CMR FT4, RoHS Compliant
- Many lengths and custom on demand

## 20SD-RCAM-M

### Application:

- Composite video patching, consumer device interconnect
- Line level unbalanced audio interconnection
- Inter and intra device A/V patching and routing
- S/PDIF coaxial audio

AVAILABLE LENGTHS: 35 FEET, 50 FEET

## COMPONENT VIDEO TRIPEX RCA CABLE FOR PERMANENT INSTALLATIONS

NON-PLENUM



### Features & Benefits:

- 3 RCA male plug to 3 RCA male plug connectivity
- Video on 26 AWG high resolution coaxial cables
- NEC CL2, CSA Type AWM I/II A/B FT4, RoHS Compliant

## E-3RCAM-M

### Application:

- Component video, A/V RCA Triplex, S/PDIF and analog L/R
- Inter and intra device interconnection



**BARGAIN BIN!**  
**PRICES DROP DAILY**  
 Check back daily for lower prices on overstock items!  
[www.LibAV.com](http://www.LibAV.com)

AVAILABLE LENGTHS: 10 FEET, 35 FEET

## Z250 TRIPLEX RCA COMPONENT VIDEO CABLE

NON-PLENUM



### Features & Benefits:

- Triplex RCA plugs (male) to Triplex RCA plugs (male)
- All gold plated contact surfaces
- Audiophile Metal RCA Body with green, red, blue ID labels
- RG59 75-Ohm video coaxial cable
- High stranding oxygen free copper conductors and shields
- Siamese (SPT) zip construction easily separated
- Extremely flexible soft PVC jacket
- UL AWM Listed, RoHS Compliant

## Z250CV

### Application:

- Component Video Y,Pb,Pr patching and routing
- Standard and High Definition Y,Pb,Pr video interconnection
- Inter and intra device video patching and routing

AVAILABLE LENGTHS: 0.5 METERS, 1 METER, 2 METERS, 3 METERS

## HIGH RESOLUTION RCA MALE TO RCA MALE PLENUM VIDEO CABLE

PLENUM



### Features & Benefits:

- RCA male to male connectivity
- Silver solder
- High resolution serial digital plenum RG59 cable
- NEC CMP, CEC CMP FT6, RoHS Compliant

## P20SD-RCAM-M

### Application:

- Low loss composite video
- Line level mono unbalanced audio
- S/PDIF Digital Audio

AVAILABLE LENGTHS: 0.5 METERS, 1 METER, 2 METERS, 3 METERS

## VGA MALE TO NON-TERMINATED END WITH C-TEC2 BNC KITTED

**PLENUM**



### Features & Benefits:

- Pre-terminated VGA end to tail connectivity
- 5 compression style MHR BNC plugs for field termination
- 200 MHz 26 AWG stranded MHR 5-wire RGB cable
- NEC CMP/CL2P, CEC CMP FT6, RoHS Compliant

## D-INSTALLKIT-CMP

### Application:

- Tight space constraints
- Conduit pulls
- RGBHV

AVAILABLE LENGTHS: 35 FEET, 40 FEET, 50 FEET, 75 FEET, 100 FEET

## VGA MALE TO 5 BNC FEMALE ADAPTER

**PLENUM**



### Features & Benefits:

- DE15 male (VGA) to 5 BNC jack (female) connectivity
- Full RF Shield, dual shielding.
- 200 MHz mini-high resolution 26 AWG coaxial construction
- CL2P/CMP rated bulk cable

## D-VGAM-5BNCF

### Application:

- RGBHV Video
- Air plenum, air handling, and plenum space install cable
- Backwards compatible to all non-plenum NEC Installs

AVAILABLE LENGTHS: 35 FEET, 40 FEET, 50 FEET, 75 FEET, 100 FEET

## VGA MALE TO 5 BNC MALE ADAPTER CABLE

**PLENUM**



### Features & Benefits:

- DE15 male (VGA) to 5 BNC plug (male) connectivity
- Silver solder and full RF copper Foil EMI shielding
- RGBHV with sync ground pin 10 to the shell
- 26 AWG 200 MHz bandwidth mini-high resolution coaxials
- Flexible plenum PVC alloy jacketing
- Metal hood with thumbscrews
- NEC CMP/CL2P, CEC CMP FT6, RoHS Compliant

## D-VGAM-5BNCM

### Application:

- RGBHV video
- Air plenum, air handling, and plenum space install cable
- Backwards compatible to all non-plenum NEC Installs

AVAILABLE LENGTHS: 10 FEET

## VGA MALE TO MALE CABLE FOR RGBHV

**PLENUM**



### Features & Benefits:

- DE15 male (VGA) to DE15 male (VGA) connectivity
- Silver solder and full RF copper foil EMI shielding
- RGBHV with sync ground pin 10 to the shell
- 26 AWG 200 MHz bandwidth mini-high resolution coaxials
- Flexible plenum PVC alloy jacketing
- Metal hoods with thumbscrews
- NEC CMP/CL2P, CEC CMP FT6, RoHS Compliant

## D-VGAM-M

### Application:

- RGBHV video
- Air plenum, air handling, and plenum space install cable
- Backwards compatible to all non-plenum NEC installs

AVAILABLE LENGTHS: 25 FEET, 35 FEET, 50 FEET, 75 FEET

## RCA MALE TO RCA MALE PLENUM BASE BAND VIDEO CABLE

**PLENUM**



**Features & Benefits:**

- RCA male to male connectivity
- Silver solder
- Plenum RG59 base band video cable
- NEC CMP, CEC CMP FT6, RoHS Compliant

## PRG59-RCAM-M

**Application:**

- Low loss composite video
- Line level mono unbalanced audio
- S/PDIF digital audio



**FIBER OPTIC SOLUTIONS**  
Page 193

AVAILABLE LENGTHS: 35 FEET, 50 FEET

## RCA MALE TO RCA MALE PLENUM BASE BAND VIDEO CABLE

**PLENUM**



**Features & Benefits:**

- DE15 Male (VGA) to unterminated connectivity
- 5 Quicklinx 25 AWG MHR compression BNC Plugs
- 250 MHz bandwidth 25 AWG solid mini hires coaxial cables
- Support shrink tubing included for installer assembly
- UL CL2P/CMP and CSA CMP, RoHS Compliant
- All in one package

## P-INSTALLKIT-CMP

**Application:**

- RGBHV installations in a plenum environment
- Installer needs to pull cable prior to termination
- VGA to 5 BNC long run RGBHV application

AVAILABLE LENGTHS: 35 FEET, 50 FEET

# LOCKING HDMI

## WHEN YOU LOSE CONNECTIVITY YOU LOSE BUSINESS



**PerfectPath**  
CONNECT WITH SOMETHING BETTER

Perfect Path's patented locking and high retention HDMI cable series boasts up to 25 lbs of retention, and equipped for 1080p and beyond.



WATCH IT NOW!  
LOCKING HDMI CABLES



HD-600B HD-700 HD-1000

**NOW AVAILABLE HERE!**

**LIBERTY**  
AV SOLUTIONS  
Distributed Product ★★★

**RUN WITH US**

SEE PAGE 104 FOR PRODUCT DETAILS



**LIBERTY**  
AV SOLUTIONS  
Distributed Product ★★★

# CONNECTORS & ADAPTORS

**RUN WITH US**

## NEUTRIK PROFESSIONAL AUDIO 1/4 INCH TS MALE CONNECTOR



1/4" PLUG

NP2C

### Features and Benefits:

- Solder style termination, 22-26 AWG cables
- Mono format with tip and sleeve only
- Silver plated contacts, nickel finish body

### Application:

- Line level mono audio, guitar cable connectors
- IR, Telephone

## NEUTRIK PROFESSIONAL AUDIO 1/4 INCH TRS MALE CONNECTOR



1/4" PLUG

NP3C

### Features and Benefits:

- Solder style termination, 22-26 AWG cables
- Stereo format with tip, ring, sleeve
- Silver plated contacts, nickel finish body

### Application:

- Line level mono balanced audio, microphone audio
- Line level stereo unbalanced audio
- IR, RS-232C, instrumentation and control

## NEUTRIK PROFESSIONAL AUDIO 1/4 INCH TRS SLIM MALE CONNECTOR



1/4" PLUG

NP3X

### Features and Benefits:

- Solder style termination, 22-26 AWG cables
- Slim body format
- Stereo format with tip, ring, sleeve
- Silver plated contacts, nickel finish body

### Application:

- Line level mono balanced audio, microphone audio
- Line level stereo unbalanced audio
- IR, RS-232C, instrumentation and control



**BARGAIN BIN!**  
**PRICES DROP DAILY**  
Check back daily for lower prices on overstock items!  
[www.LibAV.com](http://www.LibAV.com)

# BETTER, STRONGER, EXPANSIVE!

Liberty's brand new expansive website has all of the complete information and tools you need to easily research and get what you need for your next profitable installation job.

## RUN WITH US



## www.LibAV.com

- Keep all of your custom information and part numbers in a **password-protected area**
- Utilize our **Learning Center** for training videos, white papers and online product info
- Find complete, **up-to-date specs**, information and cross reference
- Check out our **super high-res product photography** & download any image you need
- Download any of our **literature** including our catalog, sell sheets & application brochures
- Find great deals on closeout items in our **Bargain Bin**, where prices drop daily
- Easily find our newest products right on the front page in our **Product Showcase**



**LIBERTY**  
AV SOLUTIONS





## 3.5MM IN-LINE MONO OR UNBALANCED AUDIO PLUG



1/8" PLUG

30-421

### Features and Benefits:

- Solder style
- Nickel plated connector and contacts
- Metal shell body and strain relief for small cable OD
- Clamp style strain relief

### Application:

- Standard diameter (<4mm) audio cables
- Unbalanced mono AUDIO, InfraRed

## 3.5MM IN-LINE STEREO OR BALANCED AUDIO JACK



1/8" JACK

30-487

### Features and Benefits:

- Solder style
- Black molded housing, nickel contacts
- Clamp style strain relief

### Application:

- Standard diameter (<4mm) audio cables
- Balanced MONO audio or unbalanced STEREO AUDIO
- InfraRed, RS-232C

## 3.5MM IN-LINE STEREO OR BALANCED AUDIO PLUG



1/8" PLUG

30-484

### Features and Benefits:

- Solder style
- Nickel plated connector and contacts
- Metal shell body and strain relief for small cable OD
- Clamp style strain relief
- Black insulator included for ground isolation

### Application:

- Standard diameter (<4mm) audio cables
- Balanced MONO audio or unbalanced STEREO AUDIO
- InfraRed, RS-232C



**SPEAKER CABLE**  
Options for any type  
of professional installation  
See Page: 64

## INTERSERIES ADAPTER 3.5MM PLUG TO RCA JACK MONO IN-LINE FORMAT



1/4" PLUG

35-538

### Features and Benefits:

- Interseries adapter 3.5mm plug to RCA jack
- Mono unbalanced format, tip and sleeve only
- Nickel plated
- In-line format without any panel mount option

### Application:

- Conversion of RCA cable to 3.5mm mono connector
- Conversion of 3.5mm mono to RCA mono
- Line level audio, composite video



**PREMADE AUDIO CABLES**  
Reliable and great quality!  
See Page: 86

# BARGAIN BIN PRICES DROP DAILY!

## GET GREAT DEALS ON OUR OVERSTOCKED PRO AV PRODUCTS

CHECK IT OUT TODAY  
WHEN THEY'RE GONE  
THEY'RE GONE!  
[WWW.LIBAV.COM](http://WWW.LIBAV.COM)



BULK & PREMADE CABLE | CONNECTORS & ADAPTORS | FIBER OPTIC SOLUTIONS  
INTELIX DIGITAL & ANALOG DEVICES | PANELCRAFTERS PLATES & PANELS  
RACKS & MOUNTS | POWER MANAGEMENT | PROFESSIONAL TOOLS & ACCESSORIES

## BNC COUPLER FEMALE TO FEMALE IN-LINE VERSION



ADAPTER **32-3119-BU**

### Features and Benefits:

- BNC female to female coupler
- Nickel plated
- 1.0 GHz
- 75 Ohm
- In-line format without any panel mount option

### Application:

- Coupling male BNC video cables together
- Extending video cables



**New Website**  
[www.LibAV.com](http://www.LibAV.com)  
**BETTER, STRONGER, EXPANSIVE!**

## BNC COUPLER MALE TO MALE IN-LINE



ADAPTER **75-699**

### Features and Benefits:

- Coupler, BNC plug (male) to BNC plug (male) connectivity
- Nickel plated, gold plated pins
- In-Line format, not for panel mount
- 75 Ohm Format

### Application:

- Coupling BNC jack (female) to BNC jack (female)
- Connecting a BNC female cable to a BNC female panel

## INTERSERIES ADAPTER BNC FEMALE TO RCA FEMALE



ADAPTER **75-629**

### Features and Benefits:

- BNC Female to RCA female Adapter
- Nickel plated
- In-Line version

### Application:

- Conversion of BNC male to RCA female
- Conversion of RCA male to BNC female
- Line level audio, composite video



**FULLY UPDATED TECH SPECS**  
For all products available online!  
[www.LibAV.com](http://www.LibAV.com)

## INTERSERIES ADAPTER BNC JACK TO RCA PLUG IN-LINE FORMAT



ADAPTER **32-3121BU**

### Features and Benefits:

- BNC female to RCA male inter series adapter
- Nickel plated
- In-line format without any panel mount option

### Application:

- Conversion of BNC video to RCA video
- Adapting RCA video to BNC and vice versa

## INTERSERIES ADAPTER BNC JACK TO AN F JACK IN-LINE FORMAT



ADAPTER **32-4003-BU**

### Features and Benefits:

- F Connector jack (female) to BNC connector jack (female)
- Nickel plated
- Bags of 10 pcs
- 75 Ohm

### Application:

- Convert any F terminated coax to a BNC jack
- Convert any BNC terminated coax to an F jack

## INTERSERIES ADAPTER BNC PLUG TO RCA JACK IN-LINE FORMAT



ADAPTER **32-3109BU**

### Features and Benefits:

- BNC male to RCA female inter series adapter
- Nickel plated
- In-line format without any panel mount option

### Application:

- Conversion of BNC video to RCA video
- Adapting RCA video to BNC and vice versa

**THE LIBERTY** **MONEY-SAVING SERVICES!**  
**EDGE** Go to [www.LibAV.com](http://www.LibAV.com) or contact your rep today to make Liberty an extension of your workforce!



**G-TEC<sup>2</sup>**  
**TERMINATION SYSTEM**

## MINI-HIGH RESOLUTION SOLID BNC PLUGS FOR SINGLE OR DUAL SHIELD

**C-TEC<sup>2</sup>**



C-TEC2 COMPRESSION | **CM-RGB25S-BNC**

**Features and Benefits:**

- BNC male plug, nickel plated
- For mini high resolution 25 AWG solid coaxial cable
- 1-piece design
- Quicklinx™ system component for quick installations
- Tested and certified to 1 GHz
- Sold and packaged in bags of 25, 5 inner bags of 5 each

**Application:**

- Base band video, analog audio, IR, S/PDIF audio
- RGBHV, RGBs, Y,Pb,Pr component video, S-video

## MINI-HIGH RES STRANDED BNC PLUGS FOR SINGLE OR DUAL SHIELD

**C-TEC<sup>2</sup>**



C-TEC2 COMPRESSION | **CM-RGB26-BNC**

**Features and Benefits:**

- BNC male plug, nickel plated
- For mini high resolution 26 AWG stranded coaxial cable
- 3-piece design, pin holder, CSR, and connector body
- Orange silicone ring and pin holder for easy ID
- Tested and certified to 1 GHz
- Sold and packaged in bags of 25, 5 inner bags of 5 each

**Application:**

- Base band video, analog audio, IR, S/PDIF audio
- RGBHV, RGBs, Y,Pb,Pr component video, S-video

## MINI-HIGH RES STRANDED BNC PLUGS FOR SINGLE OR DUAL SHIELD

**C-TEC<sup>2</sup>**



C-TEC2 COMPRESSION | **CM-RGB26-GBNC**

**Features and Benefits:**

- BNC male Plug, Gold Plated
- For mini high resolution 26 AWG stranded coaxial cable
- 3-piece design, pin holder, CSR, and connector body
- Orange silicone ring and pin holder for easy ID
- Tested and certified to 1 GHz
- Sold and packaged in bags of 25, 5 inner bags of 5 each

**Application:**

- Base band video, analog audio, IR, S/PDIF audio
- RGBHV, RGBs, Y,Pb,Pr component video, S-video

## MINI-RG59 SOLID BNC PLUGS FOR SINGLE OR DUAL SHIELD

**C-TEC<sup>2</sup>**



C-TEC2 COMPRESSION | **CM-RGB23-BNC**

**Features and Benefits:**

- Universal connector for mini-RG59 sized coaxial cable
- Single piece compression connector
- Fits both plenum and non-plenum formats
- Single braid shield through dual shield formats
- 23 AWG with up to a .100-inch dielectric
- Sky blue silicone band for easy identification
- Machined slot to accept CM-(color) ID bands

**Application:**

- Line level audio, S/PDIF and AES3id digital audio
- Base band video, IR, digital video

## MINI-RG59 STRANDED BNC PLUGS FOR SINGLE OR DUAL SHIELD

**C-TEC<sup>2</sup>**



C-TEC2 COMPRESSION | **CM-RGB25-BNC**

**Features and Benefits:**

- BNC male plug, nickel plated
- For mini-RG59 25 AWG stranded coaxial cable
- 3-piece design, pin holder, CSR, and connector body
- Purple silicone ring and pin holder for easy ID
- Tested and certified to 1 GHz
- Sold and packaged in bags of 25, 5 inner bags of 5 each

**Application:**

- Base band video, analog audio, IR, S/PDIF audio
- RGBHV, RGBs, Y,Pb,Pr component video, s-video



**TOOLS & ACCESSORIES**  
Save time and money!  
See Page: 247

## RG59 BNC PLUGS FOR SINGLE, DUAL, TRI OR QUAD SHIELD

**C-TEC<sup>2</sup>**



C-TEC2 COMPRESSION | **CM-RG59M-BNC**

**Features and Benefits:**

- Universal connector for RG59 sized coaxial cable
- Single piece compression connector
- Fits both plenum and non-plenum formats
- Single braid shield through quad shield formats
- Does not fit RG59 head end quad format (CM-RG59Q-series)
- Yellow silicone band for easy identification
- Machined slot to accept CM-(color) ID bands
- Packaged in bags of 25

**Application:**

- Line level audio, S/PDIF and AES3id digital audio
- Base band video, IR, digital video

## RG6 BNC PLUGS FOR PLENUM SINGLE, DUAL, TRI OR QUAD SHIELD

**C-TEC<sup>2</sup>**



C-TEC2 COMPRESSION **CM-RG6M-BNC**

### Features and Benefits:

- Universal plenum connector for RG6 sized coaxial cable
- Single piece compression connector
- Plenum single braid shield through quad shield formats
- Non-plenum single braid shield through tri-shield format
- Purple silicone band for easy identification
- Machined slot to accept CM-(color) ID bands

### Application:

- Line level audio, S/PDIF and AES3id digital audio
- Base band video, IR, digital video

## RG6 BNC PLUGS FOR NON-PLENUM SINGLE, DUAL, TRI OR QUAD SHIELD

**C-TEC<sup>2</sup>**



C-TEC2 COMPRESSION **CM-RG6L-BNC**

### Features and Benefits:

- Universal PVC connector for RG6 sized coaxial cable
- Single piece compression connector
- PVC Single braid shield through quad shield formats
- Plenum dual shield through quad-shield formats
- Orange silicone band for easy identification
- Machined slot to accept CM-(color) ID bands

### Application:

- Line level audio, S/PDIF and AES3id digital audio
- Base band video, IR, digital video

## CONNECTOR MARKING BANDS

**C-TEC<sup>2</sup>**



C-TEC2 ACCESSORY **CM-R**

### Features and Benefits:

- Silicone band matched to the C-Tec2 connector line
- 7 Colors to choose from
- Fits all C-Tec2 of all sizes

### Application:

- Circuit marking for signal routing
- Signal identification, L/R audio, S/PDIF audio, Y/C video
- Y,Pb,Pr, or RGBHV marking and identification



### TOOLS & ACCESSORIES

Save time and money!  
See Page: 247

## BNC CRIMP PLUG FOR RG58 PLENUM DUAL SHIELD CABLE



CRIMP **112128**

### Features and Benefits:

- BNC male plug, 3 piece precision format
- 50-Ohm impedance
- Nickel plated with gold plated pin
- 0.068" pin crimp, 0.213" hex ferrule crimp
- Fits RG58/RF195 sized solid plenum cable

### Application:

- Wireless antenna, inventory control pigtails
- Ham radio, RF radio, satellite radio

## BNC CRIMP PLUG FOR RG59 NON-PLENUM SOLID CABLE



CRIMP **112951**

### Features and Benefits:

- BNC male Plug, 3 piece precision construction
- 75-Ohm 4.0 GHz rating
- Nickel plated with gold plated pin
- Pin crimp: .042", ferrule crimp: .255"
- Fits 22-20 AWG stranded, 20 AWG solid SDI RG59 Coax

### Application:

- Video formats: RGBHV, Y,Pb,Pr, S-video, composite video
- Digital SMPTE SDI Video, AES3id digital audio
- Control: IR trigger

## BNC CRIMP PLUG FOR RG6 NON-PLENUM SOLID CABLE



CRIMP **112957**

### Features and Benefits:

- BNC male plug, 3 piece precision construction
- 75-Ohm 4.0 GHz rating
- Nickel plated with gold plated pin
- Pin crimp: .042", ferrule crimp: .320"
- Fits 18 AWG solid SDI RG6 Coax

### Application:

- Video formats: RGBHV, Y,Pb,Pr, S-video, composite video
- Digital SMPTE SDI Video, AES3id digital audio
- Control: IR trigger

## BNC CRIMP PLUG FOR RG6 PLENUM SOLID CABLE



CRIMP **112975**

### Features and Benefits:

- BNC male Plug, 3 piece precision construction
- 75-Ohm 4.0 GHz rating
- Nickel plated with gold plated pin
- Pin crimp: .042", ferrule crimp: .255"
- Fits 18 AWG solid SDI RG6 Coax

### Application:

- Video formats: RGBHV, Y,Pb,Pr, S-video, composite video
- Digital SMPTE SDI Video, AES3id digital audio
- Control: IR trigger

## BNC CRIMP PLUG FOR RG8 NON-PLENUM SOLID CABLE



CRIMP **112563**

### Features and Benefits:

- BNC male plug, 3 piece precision format
- 50-Ohm impedance
- Nickel plated with gold plated pin
- 0.118" pin crimp, 0.429" hex ferrule crimp
- Fits RG8 10 AWG solid non-plenum cable, RF400 cables

### Application:

- Wireless antenna, inventory control pigtailed
- Ham radio, RF radio, satellite radio

## BNC CRIMP PLUG FOR RG8 NON-PLENUM STRANDED CABLE



CRIMP **112562**

### Features and Benefits:

- BNC male plug, 3 piece precision format
- 50-Ohm impedance
- Nickel plated with gold plated pin
- 0.100" pin crimp, 0.429" hex ferrule crimp
- Fits RG8 13 AWG stranded non-plenum cable

### Application:

- Wireless antenna, inventory control pigtailed
- Ham radio, RF radio, satellite radio

## BNC CRIMP PLUG FOR MINI-RG59 SOLID CABLE



CRIMP **112955**

### Features and Benefits:

- BNC male plug, 3 piece precision construction
- 75-Ohm 4.0 GHz rating
- Nickel plated with gold plated pin
- Pin crimp: .042", ferrule crimp: .178"
- Fits 25-24 AWG stranded, 23 AWG solid SDI mini-RG59 coax

### Application:

- Video formats: RGBHV, Y,Pb,Pr, S-video, composite video
- Digital SMPTE SDI Video, AES3id digital audio
- Control: IR trigger

## TNC CRIMP PLUG FOR RG58 NON-PLENUM DUAL SHIELD CABLE



CRIMP **122108**

### Features and Benefits:

- TNC male plug, 3 piece precision format
- 50-Ohm impedance
- Nickel plated with gold plated pin
- 0.068" pin crimp, 0.213" hex ferrule crimp
- Fits RG58/RF195 sized solid non-plenum cable

### Application:

- Wireless antenna, inventory control pigtailed
- Ham radio, RF radio, satellite radio

## BNC CRIMP PLUG FOR RG58 NON-PLENUM DUAL SHIELD CABLE



CRIMP **112116**

### Features and Benefits:

- BNC male plug, 3 piece precision format
- 50-Ohm impedance
- Nickel plated with gold plated pin
- 0.068" pin crimp, 0.213" hex ferrule crimp
- Fits RG58/RF195 sized solid non-plenum cable

### Application:

- Wireless antenna, inventory control pigtailed
- Ham radio, RF radio, satellite radio



**BARGAIN BIN!**  
**PRICES DROP DAILY**  
Check back daily for lower prices on overstock items!  
[www.LibAV.com](http://www.LibAV.com)

## BNC JACK FOR MINI HIGH RESOLUTION COAXIAL CABLE



CRIMP | 112161-10

### Features and Benefits:

- BNC female jack, 4 piece format with dielectric stiffener
- 75-Ohm 100 MHz rating
- Nickel plated with gold plated pin
- Pin crimp: .068", ferrule crimp: .178"
- Fits 26 AWG stranded, 25 AWG solid mini high res coax cable

### Application:

- Video formats: RGBHV, Y,Pb,Pr, S-video, composite video
- Audio: analog audio and S/PDIF digital audio
- Control: IR trigger

## BNC PLUG FOR MINI HIGH RESOLUTION COAXIAL CABLE



CRIMP | MHR-BNC

### Features and Benefits:

- BNC male plug, 4 piece format with dielectric stiffener
- 75-Ohm 100 MHz rating
- Nickel plated with gold plated pin
- Pin crimp: .068", ferrule crimp: .178"
- Fits 26 AWG stranded, 25 AWG solid mini high res coax cable

### Application:

- Video formats: RGBHV, Y,Pb,Pr, S-video, composite video
- Audio: analog audio and S/PDIF digital audio
- Control: IR trigger

## TNC CRIMP PLUG FOR RG58 PLENUM DUAL SHIELD CABLE



CRIMP | 122112

### Features and Benefits:

- TNC male plug, 3 piece precision format
- 50-Ohm impedance
- Nickel plated with gold plated pin
- 0.068" pin crimp, 0.213" hex ferrule crimp
- Fits RG58/RF195 sized solid plenum cable

### Application:

- Wireless antenna, inventory control pigtails
- Ham radio, RF radio, satellite radio



**New Website**  
[www.LibAV.com](http://www.LibAV.com)  
**BETTER, STRONGER, EXPANSIVE!**

# C-TEC<sup>2</sup> TERMINATION SYSTEM

## FOR RG59, RG6, RG11, MINI RGB & AUDIO CONNECTORS

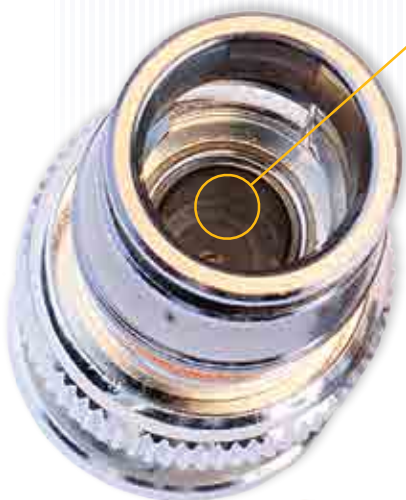

- Ferrule-less F & M series design allows any sized cable constructions from virtually any manufacturer to fit these connectors
- Significantly reduces the number of connectors required to terminate a variety of cable types

- All-metal connectors with machined slots for ID bands
- Perfect for RF video - CATV, MATV, direct broadcast satellite
- Super-simple termination process, see the video at LibAV.com or scan the QR code below

**C-TEC<sup>2</sup> COMPLETE TOOL PACK**  
CM-TOOL-PAC  
PAGE: 248



**WATCH IT NOW!**  
C-TEC<sup>2</sup> TERMINATION



**CHECK OUT OUR ENTIRE VIDEO LIBRARY AT LIBAV.COM**



## D-SUB 9-PIN FEMALE TO FEMALE 8P8C USER CONFIGURABLE ADAPTER

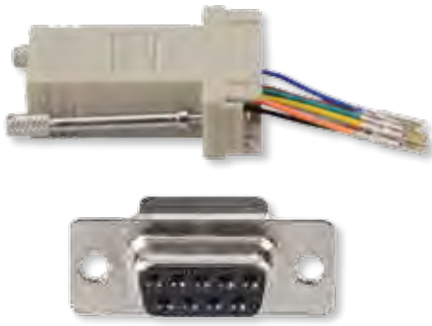

ADAPTER **32-281**

### Features and Benefits:

- AKA "Cisco adapters"
- DE09 jack (female) to RJ45 jack (female) connectivity
- RJ45 side pre-terminated with D-Sub sockets pre-applied
- DE09 side empty housing, user inserts D-Sub sockets
- Gray/beige Plastic housing with thumbscrews
- User defines the pin out and application

### Application:

- RS-232 over LAN cable conversion
- Serial control via LAN cable
- Port to RJ45 converter

## D-SUB 9-PIN MALE TO FEMALE 8P8C USER CONFIGURABLE ADAPTER



ADAPTER **32-284**

### Features and Benefits:

- AKA "Cisco adapters"
- DE09 Plug (male) to RJ45 jack (female) connectivity
- RJ45 side pre-terminated with D-Sub sockets pre-applied
- DE09 side empty housing, user inserts D-Sub sockets
- Gray/beige Plastic housing with thumbscrews
- User defines the pin out and application

### Application:

- RS-232 over LAN cable conversion
- Serial control via LAN cable
- Port to RJ45 converter

## D-SUB 9-PIN MALE TO FEMALE NULL MODEM ADAPTER



ADAPTER **31D1-28200**

### Features and Benefits:

- DB9 Male to female adapter pinned out NULL modem
- Nickel plated
- Applicable to in-line or panel mount applications

### Application:

- Conversion of straight through DB9 cable to NULL modem
- RS-232 control and routing



**VGA CABLES**  
Reliable options for any professional installation  
See Page 109

## ECONOMY D-SUB COUPLER AND ADAPTER DB9 MALE TO MALE PANEL MOUNT



ADAPTER **V21**

### Features and Benefits:

- DE09 plug (male) to DE15 plug (male) connectivity
- Includes panel mounting hardware
- Can be used as a low profile in-line gender changer
- Nickel plated connector shell and gold plated sockets
- Individual bags

### Application:

- Passing RS-232 / RS-422 through plates
- In-line coupling of DB9 cables

## ECONOMY D-SUB COUPLER AND ADAPTER VGA FEMALE TO FEMALE PANEL MOUNT



ADAPTER **V5**

### Features and Benefits:

- DE15 jack (female) to DE15 jack (female) connectivity
- Also known as HD15 and VGA connector
- Includes panel mounting hardware
- Can be used as a low profile in-line gender changer
- Nickel plated connector shell and gold plated sockets
- Individual bags
- EDID and ID/DDC Compliant

### Application:

- Passing RGBHV Video through plates/panels
- In-line coupling of VGA cables

## COOL SPOOL SYSTEM® DURABLE, VERSATILE, EASY!

Our custom designed reel box & hand truck saves time and accommodates any type of professional installation!



## ECONOMY HDMI COUPLER AND ADAPTER FEMALE TO FEMALE PANEL MOUNT



ADAPTER **V99**

### Features and Benefits:

- HDMI "A" receptacle to HDMI "A" receptacle
- All contact surfaces gold plated
- Threaded Inserts both sides for panel/plate mounting
- Also straight through in-line coupler for non-panel use

### Application:

- Passing HDMI or DVI-D single link through plate/panels
- Coupling HDMI male ends together
- Extending HDMI cables

## INTERSERIES ADAPTER FOR VGA HD15 FEMALE TO DVI ANALOG MALE



ADAPTER **DVI/VGA**

### Features and Benefits:

- DVI plug analog to VGA female interseries adapter
- Gold plated contact pins
- Beige thermoplastic overmold

### Application:

- Adapt analog DVI to VGA or vice versa
- Adapt DVI/A or DVI-I cables to VGA or vice versa



### D-SUB CRIMP TOOL

See Page 251

## LIBERTY VGA 90 DEGREE COUPLER AND ADAPTER IN-LINE FORMAT



ADAPTER **VGA90U**

### Features and Benefits:

- VGA male to VGA female with the female end facing 90 degrees up
- Thumbscrews for attachment to the source or display receptacle
- Black molding

### Application:

- VGA Signal routing and direction from the back of displays
- Tight bend and low depth routing of VGA cables

## CRIMP & POKE D-SUB JACK HOUSING CRIMP STYLE CONNECTOR SYSTEM



CRIMP **CD-9809S**

### Features and Benefits:

- Crimp and poke empty D-Sub 9-pin jack housing
- No contacts included
- Nickel plated

### Application:

- Field termination of D-Sub for RS-232 and NULL modem
- Data, control, and communications

## CRIMP & POKE D-SUB PLUG HOUSING CRIMP STYLE CONNECTOR SYSTEM



CRIMP **CD-9809M**

### Features and Benefits:

- Crimp and poke empty D-Sub 9-pin plug housing
- No contacts included
- Nickel plated

### Application:

- Field termination of D-Sub for RS-232 and NULL modem
- Data, control, and communications

## MAXBLOX D-SUB TERMINATION SYSTEM FEMALE DB9



SCREW TERMINAL **CD-MX9F**

### Features and Benefits:

- Female 9-Pin D-Sub to terminal block connectivity
- PC board mount for snap in to matching hood
- Phoenix connector screw down termination

### Application:

- RS-232, RS-422, RS-485 communications protocol
- Systems control field installation and maintenance



### VGA CABLES

Reliable options for any professional installation

See Page 109



## MAXBLOX D-SUB TERMINATION SYSTEM FEMALE VGA



SCREW TERMINAL

CD-MX15F

### Features and Benefits:

- Female high density D-Sub to terminal block connectivity
- PC board mount for snap in to matching hood
- Phoenix connector screw down termination
- Non-EDID compliant, RGBHV only cable connection

### Application:

- RGBHV field termination with VGA connectors no soldering

# WebBlox®

**GO FROM CONCEPT TO COMPLETE  
PLATE DESIGN IN JUST MINUTES!**



**ADD YOUR OWN LOGO  
FREE SERVICE  
DESIGN ONLINE, 24/7  
PASSWORD-PROTECTED ACCESS  
TO ALL OF YOUR DESIGNS**



**PANEL CRAFTERS**  
CUSTOM PLATES & PANELS

CHECK IT OUT AT [WWW.LIBAV.COM](http://WWW.LIBAV.COM)

## CRIMP AND POKE D-SUB MALE PIN CRIMP STYLE CONNECTOR SYSTEM



CRIMP

CD-9856MM

### Features and Benefits:

- Gold flash brass male pin
- Machined versus stamped construction for premium use
- 1 each is a bag of 100 pins
- Fits D-Sub standard density plug bodies (2 rows of pins)

### Application:

- Crimp and poke termination of D-Sub connectors
- Audio, video, RS-232, RS-422, RS-485

## CRIMP AND POKE D-SUB MALE PIN CRIMP STYLE CONNECTOR SYSTEM



CRIMP

CD-9856M

### Features and Benefits:

- Gold flash brass male pin
- 1 Each is a bag of 100 pins
- Fits D-Sub standard density plug bodies (2 rows of pins)

### Application:

- Crimp and poke termination of D-Sub connectors
- Audio, video, RS-232, RS-422, RS-485

## CRIMP & POKE D-SUB FEMALE SOCKET CRIMP STYLE CONNECTOR SYSTEM



CRIMP

CD-9866S

### Features and Benefits:

- Gold flash brass female socket
- 1 Each is a bag of 100 sockets
- Fits D-Sub standard density plug bodies (2 rows of pins)

### Application:

- Crimp and poke termination of D-Sub connectors
- Audio, video, RS-232, RS-422, RS-485

## MAXBLOX D-SUB TERMINATION SYSTEM HALF HOOD



SCREW TERMINAL **CD-MX915HH**

### Features and Benefits:

- Half hood with thumbscrews for MaxBlox PC board
- Upper Hood half removed for view and access to wires
- PC board snaps in to hood for security and alignment
- All hardware included

### Application:

- Closing DE09 and DE15 (VGA) connectors after termination
- Systems control field installation and maintenance

## MAXBLOX D-SUB TERMINATION SYSTEM HOOD



SCREW TERMINAL **CD-MX915H**

### Features and Benefits:

- Special hood with thumbscrews for MaxBlox PC board
- PC board snaps in to hood for security and alignment
- All hardware included

### Application:

- Closing DE09 and DE15 (VGA) connectors after termination
- Systems control field installation and maintenance

## MAXBLOX D-SUB TERMINATION SYSTEM MALE DB9



SCREW TERMINAL **CD-MX9M**

### Features and Benefits:

- Male 9-Pin D-Sub to terminal block connectivity
- PC board mount for snap in to matching hood
- Phoenix connector screw down termination

### Application:

- RS-232, RS-422, RS-485 communications protocol
- Systems control field installation and maintenance



## HDMI MOBILE ADAPTER RING GENIOUS!

See Page: 132

## MAXBLOX D-SUB TERMINATION SYSTEM MALE VGA



SCREW TERMINAL **CD-MX15M**

### Features and Benefits:

- Male high density D-Sub to terminal block connectivity
- PC board mount for snap in to matching hood
- Phoenix connector screw down termination
- Non-EDID compliant, RGBHV only cable connection

### Application:

- RGBHV field termination with VGA connectors no soldering

## ECONOMY D-SUB CONNECTOR DE15 FEMALE VGA SOLDER BACK



SOLDER **PPEDHS-15F**

### Features and Benefits:

- Solder style termination
- UL94V thermoplastic insulation with gold plated sockets
- Three rows of 5 sockets, AKA HD15 or VGA Female
- Nickel plated connector body

### Application:

- Analog video, from composite video to RGBHV video
- Analog and digital audio, RS-232, RS-422

## ECONOMY D-SUB CONNECTOR DE15 MALE VGA SOLDER BACK



SOLDER **PPEDHS-15P**

### Features and Benefits:

- Solder style termination
- UL94V thermoplastic insulation with gold plated pins
- Three rows of 5 pins, AKA HD15 or VGA male
- Nickel plated connector body

### Application:

- Analog video, from composite video to RGBHV video
- Analog and digital audio, RS-232, RS-422

## ECONOMY SOLDER STYLE D-SUB DB9 FEMALE CONNECTOR



SOLDER **DB9F**

### Features and Benefits:

- Solder style termination
- UL94V thermoplastic insulation with gold plated sockets
- 2 rows of sockets, top row of 5, bottom row of 4 AKA DB9
- Nickel plated connector body

### Application:

- Analog video, from composite video to RGBHV video
- Analog and digital audio, RS-232, RS-422

## ECONOMY SOLDER STYLE D-SUB DB9 MALE CONNECTOR



SOLDER **DB9M**

### Features and Benefits:

- Solder style termination
- UL94V thermoplastic insulation with gold plated sockets
- 2 rows of pins, top row of 5, bottom row of 4 AKA DB9
- Nickel plated connector body

### Application:

- Analog video, from composite video to RGBHV video
- Analog and digital audio, RS-232, RS-422

## HEAVY DUTY METAL HOOD FOR DE SERIES VGA AND DB9 CONNECTORS



HOOD **CD-HDVGA**

### Features and Benefits:

- Oversized cable DE format hood for VGA and DB9 connectors
- Heavy nickel plated zinc diecast hoods
- Jack screws for additional security
- Multiple grommet sizes for differing cable diameters
- Packaged as a set

### Application:

- Large cable D-Sub hood for up to .525-inch diameter cable
- Liberty RGB5-MINI Cable, RGB5C-23-CM

## METALLIZED PLASTIC DE SERIES HOODS FOR DB9 AND VGA FORMATS



HOOD **ELZ-09MT**

### Features and Benefits:

- DE Series D-Sub 180 degree format metallized plastic hood
- For VGA and DB9 connectors, male and female.
- Metal foil plated
- Thumbscrews, cable clamp, hardware
- Maximum cable size is 6.35mm / 0.25-inch

### Application:

- Closing D-Sub DE format connectors. VGA and DB9
- RS-232, RS-422 control cable termination hardware

# LOCKING HDMI

## WHEN YOU LOSE CONNECTIVITY YOU LOSE BUSINESS



PerfectPath  
CONNECT WITH SOMETHING BETTER

Perfect Path's patented locking and high retention HDMI cable series boasts up to 25 lbs of retention, and equipped for 1080p and beyond.



WATCH IT NOW!  
www.perfectpath.com



NOW AVAILABLE HERE!

LIBERTY  
AV SOLUTIONS  
Distributed Product ★★ ★

RUN WITH US

SEE PAGE 104

## METAL DE SERIES HOODS FOR DB9 AND VGA FORMATS WITH THUMBSCREWS



HOOD **MHDZK9K**

### Features and Benefits:

- DE Series D-Sub 180 degree format metal hood
- For VGA and DB9 connectors, male and female
- Nickel plated
- Thumbscrews, cable clamp, hardware
- 4-inserts 5.2, 7.2, 8.8, 9.8mm Inner diameter
- Maximum cable size is 12mm / 0.475-inch with no insert

### Application:

- Closing D-Sub DE format connectors. VGA and DB9
- RS-232, RS-422 control cable termination hardware

## C-TEC2 MINI-RG59 SOLID F PLUGS FOR SINGLE OR DUAL SHIELD FORMATS

C-TEC<sup>2</sup>



C-TEC2 F COMPRESSION **CM-RGB23-F**

### Features and Benefits:

- Universal connector for mini-RG59 sized coaxial cable
- Single piece compression connector
- Fits both plenum and non-plenum formats
- Single braid shield through dual shield formats
- 23 AWG with up to a .100-inch dielectric
- Sky blue silicone band for easy identification
- Machined slot to accept CM-(color) ID bands

### Application:

- RF video - CATV, MATV, direct broadcast satellite
- Base band video

## C-TEC2 RG11 F PLUGS FOR NON-PLENUM SINGLE, DUAL, TRI OR QUAD SHIELD FORMATS

C-TEC<sup>2</sup>



C-TEC2 F COMPRESSION **CM-RG11-F**

### Features and Benefits:

- Universal PVC connector for RG11 sized coaxial cable
- Single piece compression connector
- PVC single braid shield through quad shield formats
- Solid 14 AWG conductor required
- Black silicone band for easy identification
- Machined slot to accept CM-(color) ID bands

### Application:

- RF video - CATV, MATV, direct broadcast satellite
- Base band video

## C-TEC2 RG59 F PLUGS FOR SINGLE, DUAL, TRI OR QUAD SHIELD FORMATS

C-TEC<sup>2</sup>



C-TEC2 F COMPRESSION **CM-RG59M-F**

### Features and Benefits:

- Universal connector for RG59 sized coaxial cable
- Single piece compression connector
- Fits both plenum and non-plenum formats
- Single braid shield through quad shield formats
- Does not fit RG59 head end quad format (CM-RG59Q-series)
- Yellow silicone band for easy identification
- Machined slot to accept CM-(color) ID bands

### Application:

- RF video - CATV, MATV, direct broadcast satellite
- Base band video

## C-TEC2 RG6 F PLUGS FOR PLENUM SINGLE, DUAL, TRI OR QUAD SHIELD FORMATS

C-TEC<sup>2</sup>



C-TEC2 F COMPRESSION **CM-RG6M-F**

### Features and Benefits:

- Universal plenum connector for RG6 sized coaxial cable
- Single piece compression connector
- Plenum single braid shield through quad shield formats
- Non-plenum single braid shield through tri-shield format
- Purple silicone band for easy identification
- Machined slot to accept CM-(color) ID bands

### Application:

- RF video - CATV, MATV, direct broadcast satellite
- Base band video

## C-TEC2 RG6 F PLUGS FOR NON-PLENUM SINGLE, DUAL, TRI OR QUAD SHIELD FORMATS

C-TEC<sup>2</sup>



C-TEC2 F COMPRESSION **CM-RG6L-F**

### Features and Benefits:

- Universal PVC connector for RG6 sized coaxial cable
- Single piece compression connector
- PVC single braid shield through quad shield formats
- Plenum dual shield through quad-shield formats
- Orange silicone band for easy identification
- Machined slot to accept CM-(color) ID bands

### Application:

- RF video - CATV, MATV, direct broadcast satellite
- Base band video



C-TEC<sup>2</sup>  
TERMINATION  
SYSTEM

## F COUPLER FEMALE TO FEMALE IN-LINE OR PANEL VERSION



ADAPTER **75-520-WH**

### Features and Benefits:

- F female to female coupler
- Hex nut on barrel, nut included in package
- 1.0 GHz
- DC passing
- White insulation

### Application:

- CATV/MATV where DC power pass required
- Inline coupler to join RF cables

## F COUPLER FEMALE TO FEMALE IN-LINE VERSION



ADAPTER **31-114**

### Features and Benefits:

- F female to female coupler
- Hex nut on barrel, no nut included in package
- 1.0 GHz
- DC passing
- White insulation

### Application:

- CATV/MATV where DC power pass required
- In-line coupler to join RF cables

# FIBER OPTIC

## SOLUTIONS FOR THE AUDIO/VIDEO PROFESSIONAL

CUSTOM & STANDARD FIBER PATCH CORDS & PANELS | CUSTOM FIBER ASSEMBLIES  
CUSTOM PROJECT SERVICES | PROFESSIONAL TERMINATION TOOLS AND TRAINING

## GET THE COMPLETE FIBER TERMINATION KIT!

TKT-UNICAM-PF

SEE PAGE 256



## CORNING UNICAM SC FIBER OPTIC CONNECTOR FOR OM3/4 50/125



CORNING UNICAM CRIMP **95-050-41-X**

### Features and Benefits:

- SC plug format
- 50/125 Laser optimized multimode OM3/OM4
- Individual bag with multiple strain relief boots
- Fits both breakout and distribution style cable
- Specific for Corning Unicam PFC System

### Application:

- 10/100/1000/10GBaseT ethernet, high bandwidth media
- OEM Crestron, AMX, Savant HDMI distribution
- Audio, video, security, gate latching system install

## CORNING UNICAM LC FIBER OPTIC CONNECTOR FOR OM1 62.5/125



CORNING UNICAM CRIMP **95-000-99**

### Features and Benefits:

- LC plug format
- 62.5/125 multimode fiber
- Individual bag with multiple strain relief boots
- Fits both breakout and distribution style cable
- Specific for Corning Unicam PFC System

### Application:

- 10/100/1000BaseT ethernet, high bandwidth media
- Audio, video, security, gate latching system install

## CORNING UNICAM SC FIBER OPTIC CONNECTOR FOR OM1 62.5/125



CORNING UNICAM CRIMP **95-000-41**

### Features and Benefits:

- SC plug format
- 62.5/125 multimode fiber OM1
- Individual bag with multiple strain relief boots
- Fits both breakout and distribution style cable
- Specific for Corning Unicam PFC System

### Application:

- 10/100/1000BaseT ethernet, high bandwidth media
- Audio, video, security, gate latching system install



## FIBER OPTIC SOLUTIONS

Page 193

## MOBILE CONTENT HDMI ADAPTER RING

KEEP YOUR ADAPTERS WHERE THEY NEED TO BE AND IMMEDIATELY ACCESSIBLE FOR YOUR MOBILE CONTENT PRESENTATION PODIUM, BOARDROOM, OR DOCKING STATION!

**DIGITALINX™**



SHOWN WITH MICRO HDMI CABLE ATTACHED (NOT INCLUDED)

ADAPTER | **DL-AR**

### Features and Benefits:

- Security loop with faux ferrite and 4 adapters to HDMI
- DisplayPort Plug (Male) to HDMI Jack (Female)
- Mini DisplayPort Plug (Male) to HDMI Jack (Female)
- Mini HDMI (C) Plug (Male) to HDMI Jack (Female)
- Micro HDMI (D) Plug (Male) to HDMI Jack (Female)
- DisplayPort adapters support audio
- Faux ferrite and wire loop - attach to HDMI cable

### Application:

- Adapting various mobile content devices to HDMI
- Interfacing Laptops, Macs, iPad, Smartphone to HDMI
- Boardroom, Education, House of Worship, Presentations

“ The Digitalinx™ Adapter Ring is your solution to keep those mobile content adapters secure and safe in your presentation applications. The DL-AR is a simple locking loop of security cable combined with a neat faux ferrite bead cable clamp and specialized eyelet molded adapters for adapting various mobile content devices to your existing HDMI infrastructure.

Easily modifiable and repairable, this system can have more adapters added or ones you don't use removed.



## DISPLAYPORT MALE TO HDMI FEMALE IN-LINE ADAPTER

**DIGITALINX™**



ADAPTER | **ARDPHD**

### Features and Benefits:

- DisplayPort plug (male) to HDMI jack (female) connectivity
- Black molded connector housings
- Full audio support

### Application:

- Adapting DisplayPort to HDMI video distribution systems
- Interfacing laptops, Macs to HDMI video system

## MICRO-HDMI "D" MALE TO HDMI FEMALE IN-LINE ADAPTER

**DIGITALINX™**



ADAPTER | **ARMCHD**

### Features and Benefits:

- Micro "D" HDMI plug (male) to HDMI jack (female) connectivity
- Black molded connector housings
- Full audio support

### Application:

- Adapting Micro-HDMI to HDMI Video distribution systems
- Interfacing Mobile content devices to HDMI video systems

## MINI-DISPLAYPORT MALE TO HDMI FEMALE IN-LINE ADAPTER

**DIGITALINX™**



ADAPTER | **ARMDPHD**

### Features and Benefits:

- Mini-DisplayPort plug (male) to HDMI jack (female) connectivity
- Black molded connector housings
- Full audio support

### Application:

- Adapting Mini-DisplayPort to HDMI video distribution systems
- Interfacing Mobile content devices to HDMI video systems

## MINI-HDMI "C" MALE TO HDMI FEMALE IN-LINE ADAPTER

**DIGITALINX™**



ADAPTER | **ARMDHD**

### Features and Benefits:

- Mini "C" HDMI plug (Male) to HDMI jack (female) connectivity
- Black molded connector housings
- Full audio support

### Application:

- Adapting mini-HDMI to HDMI video distribution systems
- Interfacing laptops, Macs to HDMI video system

## DVI-D SINGLE LINK MALE TO HDMI "A" FEMALE WITH MOLDED EYELET



### ADAPTER | ARDVHD

#### Features and Benefits:

- DVI single link male to HDMI jack (female) connectivity
- Black molded connector housings

#### Application:

- Adapting HDMI Video to DVI Sinks (Displays)
- Adapting DVI Video to HDMI Sinks (Displays)



**HDMI CABLES**  
Options for any type of professional installation  
See Page: 102

## CLAMP ASSEMBLY



### ADAPTER | DL-CL

#### Features and Benefits:

- Single locking ring that hides neatly out of sight in the cable clamp
- Two sets of foam rubber inserts
- 1/2 meter pre-cut cable
- 4 sets of Torx® screws and nuts
- Cable locking ring

#### Application:

- For use with the DL-AR mobile content HDMI adapter ring
- Larger foam rubber insert is for standard HDMI cables from 6 to 10mm in diameter
- Smaller foam rubber insert is for the newer micro sized HDMI cables from 3 to 5mm in diameter

## HDM ANGLED ADAPTER WITH EXIT 90 DEGREES UP



### ADAPTER | HDMH90F

#### Features and Benefits:

- HDMI "A" male to "A" female connectivity
- All gold plated contact surfaces
- Two version, one exiting up and one exiting down
- Passive junction, no equalization

#### Application:

- HDMI digital multimedia integration and interconnection
- Routing of HDMI cables where tight spaces exist
- Inter and intra device HDMI interconnection

## MINI-DIPLAY PORT OUTPUT TO HDMI TMDS DONGLE



### ADAPTER DONGLE | E-MDPM-HDF

#### Features and Benefits:

- Mini-DisplayPort male to HDMI female
- Converts DP to TMDS HDMI/DVI
- Does not convert TMDS to DP
- Connect at the DP source only
- 6 inch cable length
- UL AWM rated for non-inwall use

#### Application:

- Adapting a DP source to an HDMI display
- Converting DP to TMDS HDMI for signal routing

## DIPLAY PORT TO HDMI TMDS DONGLE



### ADAPTER DONGLE | E-DPM-HDF

#### Features and Benefits:

- DisplayPort male to HDMI female
- Converts DP to TMDS HDMI/DVI
- Does not convert TMDS to DP
- Connect at the DP source only
- 6 inch cable length
- UL AWM rated for non-inwall use

#### Application:

- Adapting a DP source to an HDMI display
- Converting DP to TMDS HDMI for signal routing

## LIBERTY FIELD TERMINATION HD SYSTEM CONNECTORS



### CONNECTOR | DL-HDMCPK

#### Features and Benefits:

- Full HDMI® certified connectors
- 5-Pcs. connector body, upper and lower shell, 2 sleeves
- Packaged in 10-pack unbreakable trays

#### Application:

- Field termination of HD interconnection cables
- Digital multimedia routing and cabling solutions



**HD CABLE TERMINATION SYSTEM**  
Get everything you need!  
See Page 30

## C-TEC2 MINI-HIGH RES SOLID RCA PLUGS FOR SINGLE OR DUAL SHIELD FORMATS

**C-TEC<sup>2</sup>**



C-TEC2 COMPRESSION **CM-RGB25S-RCA**

### Features and Benefits:

- RCA male plug, nickel plated
- For mini high resolution 25 AWG solid coaxial cable
- 1-piece design
- Quicklinx™ system component for quick installations
- Tested and certified to 300 MHz
- Sold and packaged in bags of 25, 5 inner bags of 5 each

### Application:

- Base band video, analog audio, IR, S/PDIF audio
- RGBHV, RGBs, Y,Pb,Pr component video, S-video

## C-TEC2 MINI-HIGH RES STRANDED RCA PLUGS FOR SINGLE OR DUAL SHIELD

**C-TEC<sup>2</sup>**



C-TEC2 COMPRESSION **CM-RGB26-GRCA**

### Features and Benefits:

- RCA male plug, gold plated
- For mini high resolution 26 AWG stranded coaxial cable
- 3-piece design, pin holder, CSR, and connector body
- Orange silicone ring and pin holder for easy ID
- Tested and certified to 300 MHz
- Sold and packaged in bags of 25, 5 inner bags of 5 each

### Application:

- Base band video, analog audio, IR, S/PDIF audio
- RGBHV, RGBs, Y,Pb,Pr component video, S-video

## C-TEC2 MINI-HIGH RES STRANDED RCA PLUGS FOR SINGLE OR DUAL SHIELD

**C-TEC<sup>2</sup>**



C-TEC2 COMPRESSION **CM-RGB26-RCA**

### Features and Benefits:

- RCA male plug, nickel plated
- For mini high resolution 26 AWG stranded coaxial cable
- 3-piece design, pin holder, CSR, and connector body
- Orange silicone ring and pin holder for easy ID
- Tested and certified to 300 MHz
- Sold and packaged in bags of 25, 5 inner bags of 5 each

### Application:

- Base band video, analog audio, IR, S/PDIF audio
- RGBHV, RGBs, Y,Pb,Pr component video, S-video

## C-TEC2 MINI-RG59 SOLID RCA PLUGS FOR SINGLE OR DUAL SHIELD FORMATS

**C-TEC<sup>2</sup>**



C-TEC2 COMPRESSION **CM-RGB23-GRCA**

### Features and Benefits:

- Universal connector for mini-RG59 sized coaxial cable
- Single piece compression connector
- Fits both plenum and non-plenum formats
- Single braid shield through dual shield formats
- 23 AWG with up to a .100-inch dielectric
- Sky blue silicone band for easy identification
- Machined slot to accept CM-(color) ID bands

### Application:

- Line level audio, S/PDIF digital audio
- Base band video, IR

## C-TEC2 MINI-RG59 SOLID RCA PLUGS FOR SINGLE OR DUAL SHIELD FORMATS

**C-TEC<sup>2</sup>**



C-TEC2 COMPRESSION **CM-RGB23-RCA**

### Features and Benefits:

- Universal connector for mini-RG59 sized coaxial cable
- Single piece compression connector
- Fits both plenum and non-plenum formats
- Single braid shield through dual shield formats
- 23 AWG with up to a .100-inch dielectric
- Sky blue silicone band for easy identification
- Machined slot to accept CM-(color) ID bands

### Application:

- Line level audio, S/PDIF digital audio
- Base band video, IR

## C-TEC2 MINI-RG59 STRANDED RCA PLUGS FOR SINGLE OR DUAL SHIELD FORMATS

**C-TEC<sup>2</sup>**



C-TEC2 COMPRESSION **CM-RGB25-RCA**

### Features and Benefits:

- RCA male plug, nickel plated
- For mini-RG59 25 AWG stranded coaxial cable
- 3-piece design, pin holder, CSR, and connector body
- Purple silicone ring and pin holder for easy ID
- Tested and certified to 1 GHz
- Packaged in bags of 25, 5 inner bags of 5 each

### Application:

- Base band video, analog audio, IR, S/PDIF audio
- RGBHV, RGBs, Y,Pb,Pr component video, S-video



**DIGITAL VIDEO BULK**  
Reliable options for any type  
of professional installation  
See Page: 25



# CONNECTORS & ADAPTERS | RCA

## C-TEC2 RG59 RCA PLUGS FOR SINGLE, DUAL, TRI OR QUAD SHIELD FORMATS

**C-TEC<sup>2</sup>**



C-TEC2 COMPRESSION **CM-RG59M-RCA**

### Features and Benefits:

- Universal connector for RG59 sized coaxial cable
- Single piece compression connector
- Fits both plenum and non-plenum formats
- Single braid shield through quad shield formats
- Does not fit RG59 head end quad format (CM-RG59Q-series)
- Yellow silicone band for easy identification
- Machined slot to accept CM-(color) ID bands

### Application:

- Line level audio, S/PDIF digital audio
- Base band video, IR

## C-TEC2 RG6 RCA PLUGS FOR PLENUM SINGLE, DUAL, TRI OR QUAD SHIELD FORMATS

**C-TEC<sup>2</sup>**



C-TEC2 COMPRESSION **CM-RG6M-RCA**

### Features and Benefits:

- Universal plenum connector for RG6 sized coaxial cable
- Single piece compression connector
- Plenum single braid shield through quad shield formats
- Non-plenum single braid shield through tri-shield format
- Purple silicone band for easy identification
- Machined slot to accept CM-(color) ID bands

### Application:

- Line level audio, S/PDIF digital audio
- Base band video, IR

## C-TEC2 RG6 RCA PLUGS FOR NON- PLENUM SINGLE, DUAL, TRI OR QUAD SHIELD

**C-TEC<sup>2</sup>**



C-TEC2 COMPRESSION **CM-RG6L-RCA**

### Features and Benefits:

- Universal PVC connector for RG6 sized coaxial cable
- Single piece compression connector
- PVC Single braid shield through quad shield formats
- Plenum dual shield through quad-shield formats
- Orange silicone band for easy identification
- Machined slot to accept CM-(color) ID bands

### Application:

- Line level audio, S/PDIF digital audio
- Base band video, IR



**C-TEC<sup>2</sup>**  
TERMINATION  
SYSTEM

## ECONOMY RCA CONNECTORS FOR SMALLER DIAMETER AUDIO & VIDEO CABLE



SOLDER **ZD06**

### Features and Benefits:

- RCA Male Plug Connector
- All Gold Plated contact surfaces
- Solder Style termination with cable strain clamp
- Black Body w/silicone ID ring (White, Red, or Yellow)
- 4mm Cable OD application

### Application:

- Base Band Video (Composite, Component, S-Video)
- Line Level unbalanced audio, Infrared Trigger

## PREMIUM RCA MALE FOR 7.5MM AND SMALLER VIDEO CABLE



SOLDER **ZD03**

### Features and Benefits:

- Solder style termination with cable strain clamp
- Black body with yellow Liberty label
- 7.5mm Cable OD application (RG59 and RG6)

### Application:

- Base band video (composite, component, S-video)
- Line level unbalanced audio, InfraRed trigger

## PREMIUM RCA PAIR FOR 7.5MM AND SMALLER AUDIO CABLE



SOLDER **ZD01**

### Features and Benefits:

- Solder style termination for pin and shield
- Zinc body with Red and black ID labels
- 7.5mm Cable OD application (RG59, RG6, twisted pair)
- Matched to Z200 Bulk Cable but fits up to RG6 dual shield

### Application:

- Base band video (composite, component, S-video)
- Line level unbalanced audio, S/PDIF digital audio



### TOOLS & ACCESSORIES

Save time and money!

See Page: 247

## SNAG FREE RJ45 CONNECTOR STRAIN RELIEF BOOTS 50 PACK



### ACCESSORIES

### BOOT-S

#### Features and Benefits:

- Push over boot style strain relief for standard RJ45 plugs
- Snag free design covers the release latch
- Category 5e and category 6
- 50-pc bags, 1 each is a full bag

#### Application:

- TIA/EIA Compliant Category 6 installations strain relief
- LAN, balun, media over TWP connector protection



### CATEGORY CABLE

Options for any type of professional installation  
See Page: 17

## CATEGORY 3 EZ-RJ25 PLUGS IN A 50-PACK



### CAT 3 PLUG

### 100 026LW

#### Features and Benefits:

- Male 6P6C RJ25 plug format (AKA RJ11, RJ12)
- For unshielded Category 3 U/UTP cable
- Fits both stranded and solid conductors
- Gold flash plated contacts
- Category 3 compliant, Not PoE compliant
- Sold as an unbreakable bag of 50 connectors

#### Application:

- LAN 10/100BaseT, voice, DSL, audio, InfraRed (IR)



**CATMASTER-HD™**  
TERMINATION SYSTEM  
Perfect Termination!  
See Page: 254

## CATEGORY 6 ONE-PIECE CRIMP RJ45 PLUG



### CAT 6 PLUG

### 11108080034

#### Features and Benefits:

- Category 6 verified
- UTP solid conductor max OD of .041-inches
- Fits 24 & 23 AWG wires
- 1-piece
- UL94-V polycarbonate
- Standard RJ45 crimp tools

#### Application:

- LAN 10/100/1000BaseT
- Baluns, video over UTP, IR, RS-232
- PoE compliant

## CATEGORY 5E SHIELDED 8P8C RJ45 PLUG



### CAT 5E PLUG

### 111S08080016-34

#### Features and Benefits:

- Category 5e verified
- F/UTP & S/FTP solid conductor max OD of .042-inches
- Fits 24 AWG wires, stranded and solid conductors
- 2-piece with internal load bar
- UL94-V polycarbonate and shield
- Standard RJ45 crimp tools

#### Application:

- LAN 10/100/1000BaseT
- Baluns, video over UTP, IR, RS-232
- PoE compliant

## CATEGORY 5E ONE-PIECE CRIMP RJ45 PLUG



### CAT 5E PLUG

### 10005USOP

#### Features and Benefits:

- Male 8P8C RJ45 plug
- Gold flash plated contacts
- Unshielded cable, solid conductor, .040" max conductor
- Category 5e compliant, PoE compliant
- Crimp style
- Sold in unbreakable packages of 100 connectors

#### Application:

- LAN 10/100/1000BaseT, balun support, IP control
- Video, audio over TWP, IR

## CATEGORY 6 SHIELDED 8P8C RJ45 PLUG



### CAT 6 PLUG

### 111S08080091C34

#### Features and Benefits:

- Category 6 verified
- F/UTP & S/FTP solid conductor max OD of .052-inches
- Fits 24 & 23 AWG wires
- 2-piece with internal load bar and external cable SR
- UL94-V polycarbonate and shield
- Standard RJ45 crimp tools

#### Application:

- LAN 10/100/1000BaseT
- Baluns, video over UTP, IR, RS-232
- PoE compliant

## CATEGORY 6 EZ-RJ45 PLUGS IN A 30-PACK WITH STRAIN RELIEF

**CATMASTER-HD®**



CAT 6 PLUG **100 011LW**

**Features and Benefits:**

- Male 8P8C RJ45 plug format
- For unshielded Category 6 U/UTP cable
- Fits both stranded and solid conductors
- Gold flash plated contacts
- Includes matching economy strain relief boots
- Category 6 compliant, not PoE or HDBaseT compliant
- Sold as an unbreakable bag of 30 connectors

**Application:**

- LAN 10/100/1000BaseT, balun support, IP control
- Video, audio over TWP, IR

## CATMASTER SHIELDED RJ45 PLUG FOR CATEGORY 5E CABLE

**CATMASTER-HD®**



CAT 5E PLUG **100020**

**Features and Benefits:**

- Male 8P8C RJ45 plug format
- For shielded Category 5e F/UTP cable
- Fits both stranded and solid conductors
- Gold flash plated contacts
- Fully shielded, pressure contact with cable shield
- Category 5E compliant, not PoE or HDBaseT compliant
- Sold as an unbreakable bag of 50 connectors

**Application:**

- LAN 10/100/1000BaseT, balun support, IP control
- Video, audio over TWP, IR

## CATEGORY 6 EZ-RJ45 PLUGS IN A 50-PACK

**CATMASTER-HD®**



CAT 6 PLUG **100010LW**

**Features and Benefits:**

- Male 8P8C RJ45 plug format
- For unshielded Category 6 U/UTP cable
- Fits both stranded and solid conductors
- Gold flash plated contacts
- Strain relief purchased separately
- Category 6 compliant, not PoE or HDBaseT compliant
- Sold as an unbreakable package of 50 connectors

**Application:**

- LAN 10/100/1000BaseT, balun support, IP control
- Video, audio over TWP, IR

## CATEGORY 5E EZ-RJ45 PLUGS IN A 100-PACK

**CATMASTER-HD®**



CAT 5E PLUG **100 003B**

**Features and Benefits:**

- Male 8P8C RJ45 plug format
- For unshielded Category 5e U/UTP cable
- Fits both stranded and solid conductors
- Gold flash plated contacts
- Category 5E compliant, not PoE or HDBaseT compliant
- Sold as an unbreakable bag of 100 connectors

**Application:**

- LAN 10/100/1000BaseT, balun support, IP control
- Video, audio over TWP, IR

## HIGH PERFORMANCE CATEGORY 5E CONNECTOR STRAIN RELIEF

**CATMASTER-HD®**



CAT 5E PLUG **100035**

**Features and Benefits:**

- Integrated crimp into the RJ45 connector
- Creates a one-piece very strong termination
- Less stress on the twisted pairs, more headroom
- Better performance than standard strain reliefs
- Package is a bag of 50 strain reliefs, non-breakable

**Application:**

- Booting Category 5e U/UTP connectors
- Fabrication of compliant Category 5e patch cables
- Better grade of EZ-RJ45 boots for Category 5e plugs

## HIGH PERFORMANCE CATEGORY 6 CONNECTOR STRAIN RELIEF

**CATMASTER-HD®**



CAT 6 PLUG **100036**

**Features and Benefits:**

- Integrated crimp into the RJ45 connector
- Creates a one-piece very strong termination
- Less stress on the twisted pairs, more headroom
- Better performance than standard strain reliefs
- Package is a bag of 50 strain reliefs, non-breakable

**Application:**

- Booting Category 6 U/UTP connectors
- Fabrication of compliant Category 5e patch cables
- Better grade of EZ-RJ45 boots for Category 6 plugs

# CONNECTORS & ADAPTERS | RJ45/LAN

## CATEGORY 6A SHIELDED 8P8C RJ45 PLUG



CAT 6A **1401405012-I**

### Features and Benefits:

- Male 8P8C modular RJ45 plug
- IDC contact style for 26 to 22 AWG TWP cabling
- No special tools required, just cable prep tools
- 625 MHz sweep test and Class E<sup>A</sup> certification
- Category 5e, 6, 6A U/UTP, F/UTP, F/STP, S/FTP formats
- Integrated IDC insertion strain relief

### Application:

- LAN 10/100/1000/10GBaseT, high speed balun, digital media
- Audio, infraRed (IR), RF video, voice, voice over IP
- Any and all TWP pair cable up to 8.5mm in diameter

## CATEGORY 6A F/UTP LAN RJ45 SHIELDED KEYSTONE INSERT



CAT 6A **A68IPZA-STP**

### Features and Benefits:

- RJ45 keystone insert for Category 6A
- 180 degree IDC termination
- Supports up to 10 gigabit ethernet
- UL listed communication circuit accessory

### Application:

- LAN 10/100/1000BaseT and 10G ethernet
- Phone, voice over IP, non-LAN data
- High speed balun and twisted pair transmission

# CATMASTER-HD<sup>®</sup>

## TERMINATION SYSTEM

### PERFECT CAT CABLE TERMINATION!

COMPLETE KIT: 90131LW **SEE PAGE 254**

HEAVY DUTY  
CRIMP TOOL  
100 044LW

CABLE CUTTER  
(NOT SOLD SEPARATELY)



UTP CABLE  
JACKET STRIPPER  
15010

PACKAGE OF 100  
EZ-RJ45 PLUGS  
100 003B

# CONNECTORS & ADAPTERS | S-VIDEO

## PREMIUM MINI-DIN 4-PIN S-VIDEO MALE FOR CABLE MOUNT APPLICATIONS



MINI-DIN 4-PIN **ZD05-SLM**

### Features and Benefits:

- Solder style termination for pins and shield
- Gun-metal zinc shell with yellow Liberty markings
- 7mm cable OD application (Y/C coax cables)
- Sold as each, not a pair

### Application:

- Base band video, S-video
- Control, RS-232, IR

celerytechnologies

# FIBER OPTIC HDMI

Reliable, time-saving design with no tedious fiber terminations & requires no costly fiber tools

### ENGINEERED FOR INSTALLERS

The Celerity Detachable Fiber Optic connector supports a thin, durable fiber optic cable in multiple lengths to 1000'. The fiber optics are pre-terminated with a miniature plug (9mm width) which supports fiber optic transfer to and from HDMI.

The use of the miniature plug eliminates the need for time-consuming fiber terminations and the need for costly fiber optic tools. The miniature fiber optic plug securely connects to the Celerity Detachable HDMI connector at the source and display components.

DFO-1000P  
**SEE PAGE 105**



Sleek cable and supports up to 1000' without loss of signal integrity and HDMI specification

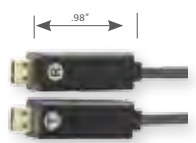

Miniature plug protects the fiber optics & internal electronics and allows for a simple and secure connection



Detachable HDMI connector makes pre-wiring of the fiber optic cable as easy as plug and play



Detachable Fiber Optic HDMI Connector

## C-TEC2 SPEAKER CONNECTOR ANGLE PIN ATTACHMENT

C-TEC<sup>2</sup>



COMPRESSION **CM-APAP**

### Features and Benefits:

- Gold plated angle pin plug for C-Tec2 speaker system
- Threads onto the CM-A-series base connector
- Interchangeable ends can be re-used
- Packaged in 25 piece bags

### Application:

- Speaker level audio
- Excellent where the termination type is not known

## C-TEC2 SPEAKER CONNECTOR BANANA PLUG ATTACHMENT

C-TEC<sup>2</sup>



COMPRESSION **CM-APBA**

### Features and Benefits:

- Gold plated banana plug for C-Tec2 speaker system
- Threads onto the CM-A-series base connector
- Interchangeable ends can be re-used
- Packaged in 25 piece bags

### Application:

- Speaker level audio
- Excellent where the termination type is not known

## C-TEC2 SPEAKER CONNECTOR SPADE LUG ATTACHMENT

C-TEC<sup>2</sup>



COMPRESSION **CM-APSL**

### Features and Benefits:

- Gold plated spade lug for C-Tec2 speaker system
- Threads onto the CM-A-series base connector
- Interchangeable ends can be re-used
- Fits stud sizes #5, #10, METRIC M3, M5, M6
- Packaged in 25 piece bags

### Application:

- Speaker level audio
- Excellent where the termination type is not known



### TOOLS & ACCESSORIES

Save time and money!  
See Page: 247

## C-TEC2 SPEAKER CONNECTOR UNIVERSAL BASE FOR 10/12 AWG

C-TEC<sup>2</sup>



COMPRESSION **CM-A-12**

### Features and Benefits:

- Gold plated base plug with threaded universal end
- User can select banana plug, spade lug, angle pin ends
- Unique design requires no stripping
- Compresses with Liberty's C-Tec2 standard tooling
- 10-12 AWG ID is a black ring
- Outer conductor OD maximum is 0.157" (4.0mm)
- Packaged in 25 piece bags

### Application:

- Speaker level audio
- Excellent where the termination type is not known

## C-TEC2 SPEAKER CONNECTOR UNIVERSAL BASE FOR 14 AWG

C-TEC<sup>2</sup>



COMPRESSION **CM-A-14**

### Features and Benefits:

- Gold plated base plug with threaded universal end
- User can select banana plug, spade lug, angle pin ends
- Unique design requires no stripping
- Compresses with Liberty's C-Tec2 standard tooling
- 14 AWG ID is a red ring
- Outer conductor OD maximum is 0.1377" (3.5mm)
- Packaged in 25 piece bags

### Application:

- Speaker level audio
- Excellent where the termination type is not known

## C-TEC2 SPEAKER CONNECTOR UNIVERSAL BASE FOR 16 AWG

C-TEC<sup>2</sup>



COMPRESSION **CM-A-16**

### Features and Benefits:

- Gold plated base plug with threaded universal end
- User can select banana plug, spade lug, angle pin ends
- Unique design requires no stripping
- Compresses with Liberty's C-Tec2 standard tooling
- 16 AWG ID is a blue ring
- Outer conductor OD maximum is 0.114" (2.9mm)
- Packaged in 25 piece bags

### Application:

- Speaker level audio
- Excellent where the termination type is not known

## ECONOMY DUAL BANANA PLUG PAIRS FOR SPEAKER LEVEL AUDIO CABLE



SCREW TYPE **ZB04**

### Features and Benefits:

- Dual banana plug connector pair (1 red, 1 black)
- All gold plated contact surfaces
- Double tap screw type terminal connection
- Pair is red and black screw on body for + and - ID
- 10 and 12 AWG wire size

### Application:

- Speaker level audio connection, Bi-Wire and Bi-Amp
- Instrument lead, DC power patching

## ECONOMY SINGLE BANANA PAIRS FOR 10-12 AWG SPEAKER LEVEL AUDIO CABLE



SCREW TYPE **ZB01**

### Features and Benefits:

- Banana plug connector pair
- All gold plated contact surfaces
- Double tap screw type terminal connection
- Pair is red and black screw on body for + and - ID
- 10 and 12 AWG wire size

### Application:

- Speaker level audio connection
- Instrument lead, DC power patching

## ECONOMY SINGLE BANANA PAIRS FOR 14-18 AWG SPEAKER LEVEL AUDIO CABLE



SCREW TYPE **ZB02**

### Features and Benefits:

- Banana plug connector pair (1 red, 1 black)
- All gold plated contact surfaces
- Double tap screw type terminal connection
- Pair is red and black screw on body for + and - ID
- 18 to 14 AWG wire size

### Application:

- Speaker level audio connection
- Instrument lead, DC power patching



**SPEAKER CABLE**  
Options for any type  
of professional installation  
See Page: 64

## PREMIUM SINGLE BANANA PAIRS FOR SPEAKER LEVEL AUDIO CABLE



SCREW TYPE **ZB03**

### Features and Benefits:

- Banana plug connector pair (1 red, 1 black)
- All gold plated connectors, bodies and pins
- Hand screw compression type terminal connection
- Red and black rings for + and - ID
- 18 to 10 AWG wire sizes

### Application:

- Speaker level audio connection
- Instrument lead, DC power patching

## NEUTRIK PROFESSIONAL AUDIO SPEAKON TWIST AND LOCK SPEAKER CONNECTOR



TWIST AND LOCK **NL2FC**

### Features and Benefits:

- Neutrik patented Speakon jack (female) cable mount
- 2-Pole format for 1 speaker
- Screw terminal termination style with chuck strain relief
- Silver plated contacts
- Air-tight twist and lock mating

### Application:

- Quick connect speaker applications
- Tactical, rental, stage speaker connections

## NEUTRIK PROFESSIONAL AUDIO SPEAKON TWIST AND LOCK SPEAKER CONNECTOR



TWIST AND LOCK **NL4FC**

### Features and Benefits:

- Neutrik patented Speakon jack (female) cable mount
- 4-Pole format for 2 speakers or bi-wiring 1 speaker
- Screw terminal termination style with chuck strain relief
- Silver plated contacts
- Air-tight twist and lock mating

### Application:

- Quick connect speaker applications
- Tactical, rental, stage speaker connections

## NEUTRIK PROFESSIONAL AUDIO XLR 3-PIN FEMALE CONNECTOR



FEMALE CONNECTOR **NC3FXX**

### Features and Benefits:

- Solder style termination, 22-26 AWG cables
- Improved strain relief and shell
- Ergonomic latch release mechanism
- 360 degree socket contact with new cage feature
- Silver plated contacts, nickel finish body

### Application:

- Line level mono balanced audio, microphone audio
- Line level stereo unbalanced audio, RS-485 simplex
- IR, RS-232C, instrumentation and control

## NEUTRIK PROFESSIONAL AUDIO XLR 3-PIN MALE CONNECTOR



MALE CONNECTOR **NC3MXX**

### Features and Benefits:

- Solder style termination, 22-26 AWG cables
- Improved strain relief and shell
- Ergonomic latch release mechanism
- Internal latch replaces older style window
- Silver plated contacts, nickel finish body

### Application:

- Line level mono balanced audio, microphone audio
- Line level stereo unbalanced audio, RS-485 simplex
- IR, RS-232C, instrumentation and control

## NEUTRIK PROFESSIONAL AUDIO XLR 4-PIN FEMALE CONNECTOR



FEMALE CONNECTOR **NC4FXX**

### Features and Benefits:

- Solder style termination, 22-26 AWG cables
- Improved strain relief and shell
- Ergonomic latch release mechanism
- 360 degree socket contact with new cage feature
- Silver plated contacts, nickel finish body

### Application:

- Line level mono balanced audio, microphone audio
- Line level stereo unbalanced audio, RS-485 modified
- IR, RS-232C, instrumentation and control

## NEUTRIK PROFESSIONAL AUDIO XLR 4-PIN MALE CONNECTOR



MALE CONNECTOR **NC4MXX**

### Features and Benefits:

- Solder style termination, 22-26 AWG cables
- Improved strain relief and shell
- Ergonomic latch release mechanism
- Internal latch replaces older style window
- Silver plated contacts, nickel finish body

### Application:

- Line level mono balanced audio, microphone audio
- Line level stereo unbalanced audio, RS-485 modified
- IR, RS-232C, instrumentation and control

## NEUTRIK PROFESSIONAL AUDIO XLR 5-PIN FEMALE CONNECTOR



FEMALE CONNECTOR **NC5FXX**

### Features and Benefits:

- Solder style termination, 22-26 AWG cables
- Improved strain relief and shell
- Ergonomic latch release mechanism
- 360 degree socket contact with new cage feature
- Silver plated contacts, nickel finish body

### Application:

- Line level mono balanced audio, microphone audio
- Line level stereo unbalanced audio, RS-485 duplex
- IR, RS-232C, instrumentation and control

## NEUTRIK PROFESSIONAL AUDIO XLR 5-PIN MALE CONNECTOR



MALE CONNECTOR **NC5MXX**

### Features and Benefits:

- Solder style termination, 22-26 AWG cables
- Improved strain relief and shell
- Ergonomic latch release mechanism
- Internal latch replaces older style window
- Silver plated contacts, nickel finish body

### Application:

- Line level mono balanced audio, microphone audio
- Line level stereo unbalanced audio, RS-485 duplex
- IR, RS-232C, instrumentation and control

## AMPHENOL PRO-AUDIO QUICK TERMINATION IDC XLR CONNECTORS



QUICK TERMINATION **AC3FIB**

### Features and Benefits:

- Quick assembly IDC contact termination
- 22-24 AWG twisted shielded pair audio cable
- No soldering required
- 3-pin format for balanced audio and control solutions

### Application:

- Line level balanced audio and unbalanced stereo audio
- Microphone level audio



**BARGAIN BIN!**  
**PRICES DROP DAILY**  
Check back daily for lower prices on overstock items!  
[www.LibAV.com](http://www.LibAV.com)

## AMPHENOL PRO-AUDIO QUICK TERMINATION IDC XLR CONNECTORS



QUICK TERMINATION **AC3MI**

### Features and Benefits:

- Quick assembly IDC contact termination
- 22-24 AWG twisted shielded pair audio cable
- No soldering required
- 3-pin format for balanced audio and control solutions

### Application:

- Line level balanced audio and unbalanced stereo audio
- Microphone level audio

## AMPHENOL PRO-AUDIO QUICK TERMINATION IDC XLR CONNECTORS



QUICK TERMINATION **AC3MIB**

### Features and Benefits:

- Quick assembly IDC contact termination
- 22-24 AWG twisted shielded pair audio cable
- No soldering required
- 3-pin format for balanced audio and control solutions

### Application:

- Line level balanced audio and unbalanced stereo audio
- Microphone level audio

## AMPHENOL PRO-AUDIO QUICK TERMINATION IDC XLR CONNECTORS



QUICK TERMINATION **AC3FI**

### Features and Benefits:

- Quick assembly IDC contact termination
- 22-24 AWG twisted shielded pair audio cable
- No soldering required
- 3-Pin format for balanced audio and control solutions

### Application:

- Line level balanced audio and unbalanced stereo audio
- Microphone level audio

# LEVERAGE OUR SERVICES AS AN EXTENSION OF YOUR WORKFORCE!

## THE LIBERTY EDGE

Consolidate purchases, save time, labor and improve your profitability by putting the expansive Liberty Edge services to work for you!







**intelix**  
DIGITAL & ANALOG DEVICES

# SIGNAL MANAGEMENT

**RUN WITH US**

# intelix

## THE EVOLUTION OF A COMPANY

A brand of Liberty AV Solutions since 2010, Intelix has been manufacturing award-winning technology for more than 20 years. Originally dedicated to the professional audio and live sound markets, Intelix has evolved into a leading provider of commercial install, custom install, digital signage, and video distribution technology. In recent years their HDMI extenders, scalars and matrix switchers have won numerous awards,

including CE Pro Best honors, SVI best commercial technology honors, and Custom Retailer Exclte honors. Intelix continues to lead the industry with application driven solutions that excel both in performance and durability, and their innovative engineering team continues to deliver technology firsts. Design with Intelix and design with intelligence.

### OEM Development & Manufacturing

Intelix's extensive experience and diverse capabilities allow for cutting-edge engineering and scalable manufacturing for both them and their clients.

### Commercial Audio

Intelix's rich background in commercial audio set the stage for application-based product development and a deep understanding of serving the audio-visual professional, whether sales engineer, designer, installer or consultant.

### Commercial Audio/Video

As the industry evolved, so did Intelix. Today they are one of the few suppliers that understands the function and integration of both audio and video, whether analog or digital.

### Digital Media

An early adopter of digital standards, Intelix recognized the advantages and future of digital media. They were the first manufacturer to reliably bring HDMI into the commercial market, and their innovation continues with wireless and LAN-based audio-visual technologies.

### Residential Audio/Video

Intelix responded to customer requests and introduced the first professional-grade digital distribution solutions to the custom installation audience. Today they continue that innovation through robust product development and complete solutions.



### The Liberty Edge

Becoming a formal division of Liberty AV Solutions in 2011, Intelix has become an even more dynamic brand within a broad portfolio of products. For the first time ever, audio-visual professionals have a single partner dedicated to improving their profitability through business and packaged technology solutions.



### One Wesco

Liberty and Intelix draw on the strength of their parent company—Wesco International, Inc.—to continue expanding and innovating. A fortune 500 company, Wesco delivers an extensive network of resources and opportunities for their companies and their companies' clients. With Wesco's backing, Intelix brings the future to today.



1984



1985



1986



1993



1994



1995



1998



OEM DEVELOPMENT & MANUFACTURING



COMMERCIAL AUDIO



COMMERCIAL AUDIO/VIDEO

# BETTER, STRONGER, EXPANSIVE!

[www.LibAV.com](http://www.LibAV.com)

Liberty's brand new expansive website has all of the complete information and tools you need to easily research and get what you need for your next profitable installation job.



- Keep all of your custom information and part numbers in a **password-protected area**
- Utilize our **Learning Center** for training videos, white papers and online product info
- Find complete, **up-to-date specs**, information and cross reference
- Check out our **super high-res product photography** & download any image you need
- Download any of our **literature** including our catalog, sell sheets & application brochures
- Find great deals on closeout items in our **Bargain Bin**, where prices drop daily
- Easily find our newest products right on the front page in our **Product Showcase**



**RUN WITH US**



2004

**intelix**  
DIGITAL & ANALOG DEVICES



2005

**DIGITAL VIDEO**



2007

**RESIDENTIAL AUDIO/VIDEO**



2010

**MERGER WITH LIBERTY AV SOLUTIONS**

**intelix**  
DIGITAL & ANALOG DEVICES

**LIBERTY**  
AV SOLUTIONS

2013

**COMPLETE AUDIO/VIDEO CONNECTIVITY SOLUTIONS**

## DISTRIBUTION AMP FOR AVOCAT SERIES BALUNS - 1 INPUT X 8 OUTPUT

AVO-Series

AVDA-8-F



FRONT

BACK



Scan QR code to save a text link to detailed specs, info, & available training videos

### Features & Benefits:

- Distributes a single source to eight destinations
- Linkable up to 64 total destinations
- Compatible with the Intelix AvoCat Series composite video, S-Video, and analog audio extenders

### Application:

- Route a single analog audio/video source to multiple destinations
- Ideal for corporate facilities, churches, schools, and conference centers



### CATEGORY CABLE

Options for any type of professional installation  
See Page: 17

MAX DISTANCE: BASED ON EXTENDERS BEING USED WITH AVDA-8-F

COMPATIBLE DEVICES: ALL COMPOSITE VIDEO, S-VIDEO, AND AUDIO-ONLY AVOCAT SERIES BALUNS, ALL COMPONENT VIDEO, VGA, USB, AND MICROPHONE EXTENDERS ARE NOT COMPATIBLE

## HDMI OVER TWISTED-PAIR DISTRIBUTION AMP - 1 INPUT X 4 OUTPUT

HDMI

DIGI-HD-1X4



Scan QR code to save a text link to detailed specs, info, & available training videos

### Features & Benefits:

- 1 HDMI input by 4 twisted pair outputs
- HDMI & HDCP compliant
- Supports 1080p, 1080i, all HDMI Audio
- 3D compatible
- Supports infrared (IR) signal distribution
- HDMI video/audio over 1 twisted pair cable
- HDMI video/audio and IR control over 2 twisted pair cables

### Application:

- Route a single analog audio/video source to multiple destinations
- Ideal for corporate facilities, churches, schools, and conference centers



### RJ45 CONNECTORS

Options for any type of professional installation  
See Page: 136

MAX DISTANCE: PER LINKED UNIT - (CAT 5E): 1080P - 100 FEET; 1080I/720P - 200 FEET; 480I/480P/576I/576P - 200 FEET

COMPATIBLE DEVICES: DIGI-HD-UHR2-R, DIGI-HD-UHR2-WP-R, DIGI-HD-IR3-WP-R, DIGI-HD-IR3-R, WP VERSION, DIGI-HD-XR

## HDMI OVER TWISTED-PAIR DISTRIBUTION AMP - 1 INPUT X 4 OUTPUT

HDMI

DIGI-HD-1X8



Scan QR code to save a text link to detailed specs, info, & available training videos

### Features & Benefits:

- 1 HDMI input by 8 twisted pair outputs
- HDMI & HDCP compliant
- Supports 1080p, 1080i, all HDMI Audio
- 3D compatible
- Supports infrared (IR) signal distribution
- HDMI video/audio over 1 twisted pair cable
- HDMI video/audio and IR control over 2 twisted pair cables
- Linkable up to 35 total outputs

### Application:

- HDMI multimedia distribution
- 1080p up to 150' over shielded Cat6A cable with compatible receive units
- Digital signage, restaurant and bar, residential HDMI



### CUSTOMER SERVICE

We offer technical assistance on all of our products or applications!  
Call us at 800-530-899 or email:  
[orders@LibAV.com](mailto:orders@LibAV.com)

MAX DISTANCE: PER LINKED UNIT - (CAT 5E): 1080P - 100 FEET; 1080I/720P - 200 FEET; 480I/480P/576I/576P - 200 FEET

COMPATIBLE DEVICES: DIGI-HD-UHR2-R, DIGI-HD-UHR2-WP-R, DIGI-HD-IR3-WP-R, DIGI-HD-IR3-R, WP VERSION, DIGI-HD-XR

# HDMI OVER COAX

You already have coax cable installed, leverage it for an HDMI upgrade!



## DIGI-HD-COAX2

Designed for demanding commercial and residential audio-visual applications, our digital coax baluns employ Intelix's industry-leading digital processing to transmit high-definition HDMI signals over a single RG6 or RG59 cable. Plus, built-in amplified signal splitting provides seamless daisy-chain distribution to ten remote destinations.

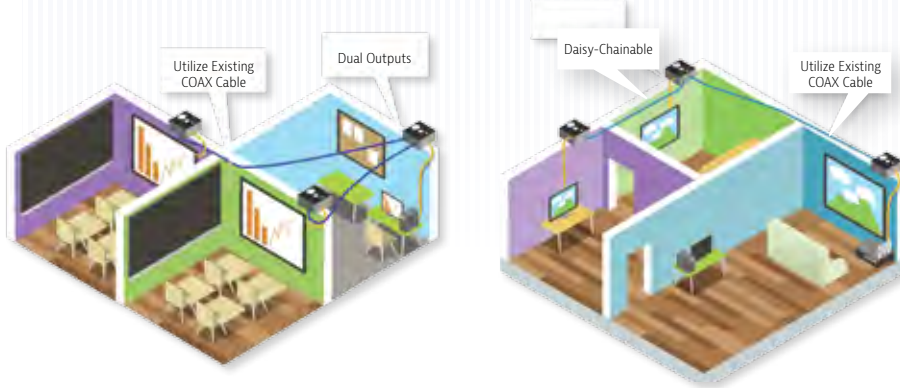

## HDMI OVER COAX - TRANSMITTER

HDMI



## DIGI-HD-COAX2-S



Scan QR code to save a text link to detailed specs, info, & available training videos

### Features & Benefits:

- 1080p up to 300 feet (92m), 1080i/720p up to 650 feet (200m)
- Linkable up to 7 units
- Stereo, 5.1 and 7.1 audio support
- HDCP compliant
- Built-in 1x2 splitter
- 10.4 Gb/s amplifier bandwidth
- Transmitters and receivers are sold individually

### Application:

- HDMI multimedia extension, plenum HDMI routing
- Digital signage, restaurant and bar
- Long distance HDMI extension (through DIGI-HD-COAX2-R daisy chaining)



**DIGITAL VIDEO BULK**  
Reliable options for any type of professional installation  
See Page: 25

MAX DISTANCE: 1080P: 300 FEET RG6; 1080I/720P: 650 FEET RG6; 480I/480P: NOT SUPPORTED  
COMPATIBLE DEVICES: DIGI-HD-COAX2-R

## HDMI OVER COAX - RECEIVER

HDMI



## DIGI-HD-COAX2-R



Scan QR code to save a text link to detailed specs, info, & available training videos

### Features & Benefits:

- 1080p up to 300 feet (92m), 1080i/720p up to 650 feet (200m)
- Linkable up to 7 units
- Stereo, 5.1 and 7.1 audio support
- HDCP compliant
- Built-in 1x2 splitter: one HDMI output, one coaxial loop output
- 10.4 Gb/s amplifier bandwidth
- Receiver only - requires DIGI-HD-COAX2-S

### Application:

- HDMI multimedia extension, plenum HDMI routing
- Digital signage, restaurant and bar
- Long distance HDMI extension (through DIGI-HD-COAX2-R daisy chaining)

MAX DISTANCE: 1080P: 300 FEET RG6; 1080I/720P: 650 FEET RG6; 480I/480P: NOT SUPPORTED  
COMPATIBLE DEVICES: DIGI-HD-COAX2-S

## Whole House Distribution

Intelix products are ideal for residential applications, including whole house audio/video distribution and home theaters. Typically several different types of technology are deployed in the home, especially in retrofit applications where existing cable is present. Intelix DIGI-HD-COAX2 extenders leverage RG59 and RG6 cable to transmit HDMI, and Intelix SKYPLAY-HD extenders provide for wireless distribution. A centrally located switcher/scaler, such as the Intelix DIGI-SCAL-11X2, consolidates analog and digital sources and provides a high-definition digital output, and an Intelix FLX-8X8A matrix distributes the signals throughout the house via twisted pair and DIGI-HDE extenders.

### SUPPORT CABLES:



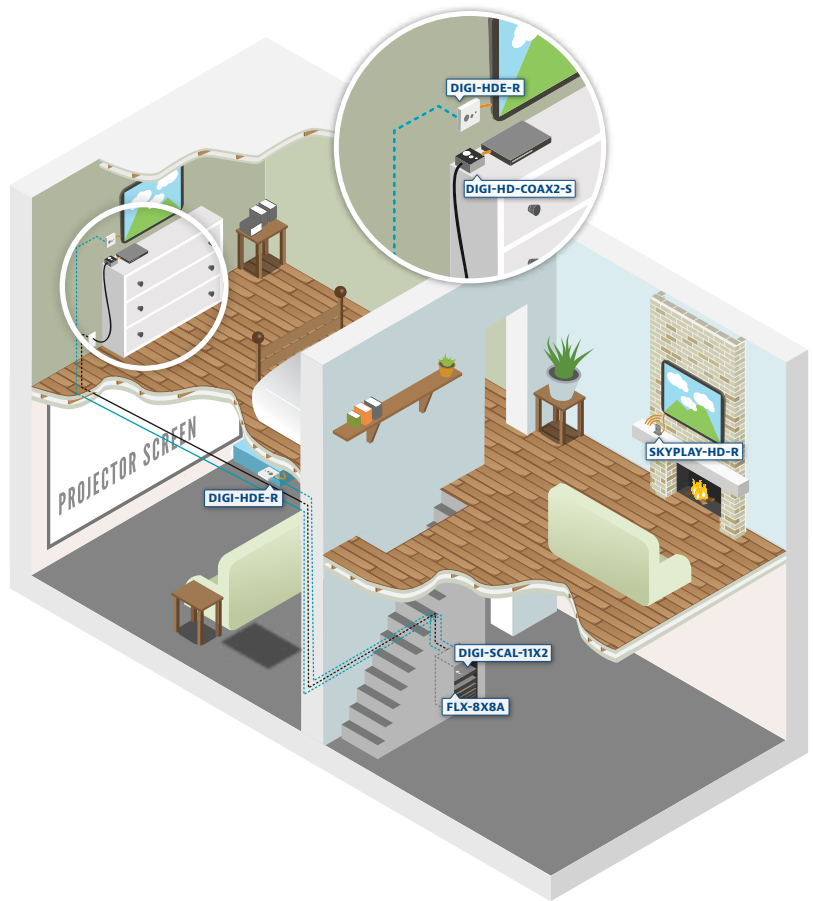

-  CATEGORY CABLE
-  HDMI CABLE
-  COAX CABLE



## Lecture Hall / Public Speaking

Intelix products are ideal for higher education applications, including classrooms, auditoriums, learning labs, and lecture halls. The below drawing shows a common installation integrating both analog and digital equipment. Audio-visual sources are connected to an Intelix DIGI-SCAL-5 located in a podium, which is connected to an Intelix FLX-8X8A switcher via a DIGI-HDE extender set. The FLX-8X8A provides for greater signal distribution, including output routing to projectors and overflow rooms. An Intelix AVO-USB extender completes the system by routing keyboard and mouse signals from the podium to a remote PC.

### SUPPORT CABLES:

-  CATEGORY CABLE
-  HDMI CABLE
-  USB CABLE
-  VGA CABLE

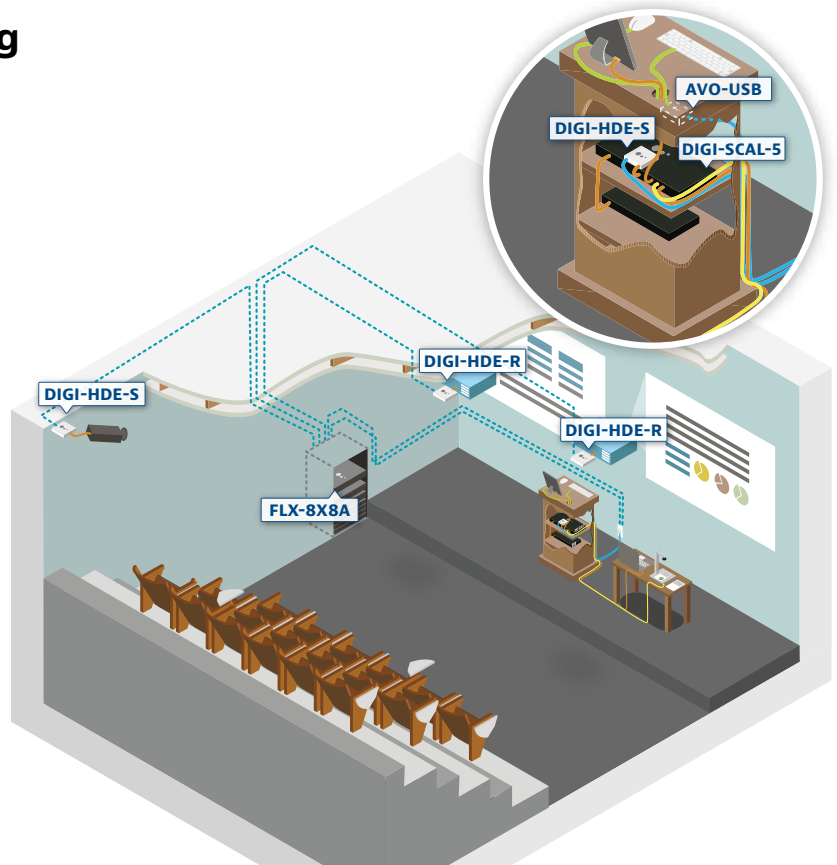

# WIRELESSLY SEND HDMI SIGNALS

**EVEN THROUGH DRYWALL!**

No Line of Sight Needed



SHOWN WITH INCLUDED CRADLES



SOLD SEPARATELY

## WIRELESS HDMI RECEIVER

HDMI

## SKYPLAY-HD-R



SIDE



Scan QR code to save a text link to detailed specs, info, & available training videos

### Features & Benefits:

- Receives wireless transmission of uncompressed 1080p video and stereo audio up to 100 feet
- HDMI and compliant
- Supports 480i/p, 576i/p, 720p, 1080i/p, and VESA resolutions up to 1920x1080
- Can be used as a wireless HDMI distribution amplifier - up to 20 receivers per transmitter
- Less than 3ms AV latency

### Application:

- Send HDMI signal from a source to a destination device without a wired connection
- Wireless HDMI distribution amplifier - up to 20 destinations
- Ideal for residential AV, digital signage, corporate facilities, churches, schools, and almost any application where a wired HDMI connection is not possible



**HDMI MOBILE ADAPTER RING**  
GENIOUS!

See Page: 132

MAX DISTANCE: 100 FEET

COMPATIBLE DEVICES: SKYPLAY-HD-S

## WIRELESS HDMI TRANSMITTER

HDMI

## SKYPLAY-HD-S



SIDE



Scan QR code to save a text link to detailed specs, info, & available training videos

### Features & Benefits:

- Transmits uncompressed 1080p video and stereo audio up to 100 feet
- HDMI and HDCP compliant
- Supports 480i/p, 576i/p, 720p, 1080i/p, and VESA resolutions up to 1920x1080
- Can be used as a wireless HDMI distribution amplifier - up to 20 receivers per transmitter
- Less than 3ms AV latency

### Application:

- Send HDMI signal from a source to a destination device without a wired connection
- Wireless HDMI distribution amplifier - up to 20 destinations
- Ideal for residential AV, corporate facilities, churches, schools, conference centers, and almost any application where a wired connection is not possible



**HDMI CABLES**  
Options for any type of professional installation  
See Page: 102

MAX DISTANCE: 100 FEET

COMPATIBLE DEVICES: SKYPLAY-HD-R

## HDMI & IR OVER TWISTED-PAIR EXTENDER & REPEATER

DIGI-HD-XR

HDMI



Scan QR code to save a text link to detailed specs, info, & available training videos

### Features & Benefits:

- Extends HDMI and IR up to 300' over Cat 5/Cat 5e/Cat 6 as an inline repeater
- Local HDMI output and IR input provides audio and video to a connected display and an IR connection point
- Compatible with most DigiCat series extenders and matrices

### Application:

- Extend signals from DigiCat series matrices and extenders beyond the 300' limit
- Ideal for residential AV, digital signage, corporate facilities, churches, and schools



**BARGAIN BIN!  
PRICES DROP DAILY**  
Check back daily for lower prices on overstock items!  
[www.LibAV.com](http://www.LibAV.com)

MAX DISTANCE: CAT 5E: 1080P @ 30M/100 FT.; 720P/1080I @ 200 FT.; CAT 6: 1080P @ 45M/150 FT.; 720P/1080I @ 300 FT.

COMPATIBLE DEVICES: DIGI-HD-UHR2, DIGI-HD-IR2, DIGI-HD-4X2, DIGI-HD-4X4, DIGI-HD-4X8, DIGI-HD-8X8, DIGI-HD-IR3, DIGI-HD-UHR2-WP, DIGI-HD-IR3-WP

## DIGITAL EXTENDER HDMI DISTRIBUTION AMPLIFIER 1 IN 2 OUT

DL-HDD12

HDMI

DIGITALINX™



### Features & Benefits:

- 2.25 Gbps per channel = 6.75 Gbps data rate
- Supports 1080p60, deep color
- Does not support ethernet, bi-directional audio, 3D
- Supports Receivers, Extenders
- HDCP compliant, HDMI 1.3 compliant
- Full equalization and amplification on each output

### Application:

- HDMI distribution 1 input to 2 outputs
- Single Source shared to two displays



**HDMI CABLES**  
Options for any type of professional installation  
See Page: 102

MAX DISTANCE: DISTANCE IS CABLE AND EXTENDER DEPENDENT

COMPATIBLE DEVICES: ALL LIBERTY CABLE AND INTELIX EXTENDERS

## DIGITAL EXTENDER HDMI DISTRIBUTION AMPLIFIER 1 IN 5 OUT

DL-HDD15

HDMI

DIGITALINX™



### Features & Benefits:

- 1.65 Gbps per channel = 4.95 Gbps data rate
- Supports 1080p60
- Does not support ethernet, bi-directional audio, 3D
- Does not supports receiver or extenders in the circuit
- Only supports PCM stereo audio
- HDCP compliant, HDMI 1.3 compliant
- Full equalization and amplification on each output

### Application:

- HDMI distribution 1 input to 5 outputs
- Single source shared to up to five displays
- Digital signage



**FULLY UPDATED TECH SPECS**  
For all products available online!  
[www.LibAV.com](http://www.LibAV.com)

MAX DISTANCE: DISTANCE IS CABLE AND EXTENDER DEPENDENT

COMPATIBLE DEVICES: ALL LIBERTY CABLE AND INTELIX EXTENDERS



## VGA AND STEREO AUDIO OVER TWISTED-PAIR EXTENDER & DISTRIBUTION AMP

### DIGI-VGA-F

#### VGA



2 DEVICES, SOLD AS A SET



DIGI-VGA-R-F BACK

DIGI-VGA-S-F BACK



Scan QR code to save a text link to detailed specs, info, & available training videos

#### Features & Benefits:

- RGBHV video up to 1920x1200 at 250 feet down to 800x600 at 850 feet (Cat 6)
- Local output on send balun for added versatility
- Receive balun features dual amplified audio/video outputs for signal distribution
- Brightness, contrast, and picture quality controls
- Sold as a send/receive pair

#### Application:

- Extend 1920x1200 up to 250 feet, lower resolutions can be transmitted over longer distances
- Ideal for corporate facilities, churches, schools, and conference centers



#### CUSTOMER SERVICE

We offer technical assistance on all of our products or applications! Call us at 800-530-899 or email: [orders@LibAV.com](mailto:orders@LibAV.com)

**MAX DISTANCE:** 1920 X 1200 RESOLUTION 250 FEET; 1600 X 1200 RESOLUTION 350 FEET; 1280 X 1024 RESOLUTION 500 FEET; 1024 X 768 RESOLUTION 700 FEET; 800 X 600 RESOLUTION 850 FEET

**COMPATIBLE DEVICES:** N/A

## VGA, STEREO AUDIO, IR & RS232 OVER TWISTED-PAIR DISTRIBUTION AMP - 8 OUTPUT

### DIGI-VGASD2-T8

#### VGA



Scan QR code to save a text link to detailed specs, info, & available training videos

#### Features & Benefits:

- Transmits computer video, stereo audio, and control signals to eight remote destinations over twisted pair cable, such as Cat 5e or Cat 6
- Local VGA and stereo audio outputs
- EDID copy feature stores destination device's EDID information onto DIGI-VGASD2-S
- Can pass resolutions up to 1920x1200 and 20 Hz to 20 kHz audio up to 350 feet
- IR and RS232 extension up to 350 feet, bi-directional IR on output 1 only
- Linkable up to 32 total outputs

#### Application:

- Transmit computer video, audio, and control signals to four remote destinations up to 350 feet away
- Ideal for digital signage, corporate facilities, churches, schools, and conference centers
- Designed for point-to-many configurations (8 destination devices)

**MAX DISTANCE:** 350 FEET

**COMPATIBLE DEVICES:** DIGI-VGASD2-R

## VGA, STEREO AUDIO, IR & RS232 OVER TWISTED-PAIR DISTRIBUTION AMP - 4 OUTPUT

### DIGI-VGASD2-T4

#### VGA



Scan QR code to save a text link to detailed specs, info, & available training videos

#### Features & Benefits:

- Transmits computer video, stereo audio, and control signals to four remote destinations over twisted pair cable, such as Cat 5e or Cat 6
- Local VGA and stereo audio outputs
- EDID copy feature stores destination device's EDID information
- Can pass resolutions up to 1920x1200 and 20 Hz to 20 kHz audio up to 350 feet
- IR and RS232 extension up to 350 feet, bi-directional on output 1 only

#### Application:

- Transmit computer video, audio, and control signals to four remote destinations up to 350 feet away
- Ideal for digital signage, corporate facilities, churches, schools, and conference centers
- Designed for point-to-many configurations (4 destination devices)

**MAX DISTANCE:** 350 FEET

**COMPATIBLE DEVICES:** DIGI-VGASD 2-R

## VGA, STEREO AUDIO, IR & RS232 OVER TWISTED-PAIR EXTENDER - RECEIVER

### DIGI-VGASD2-R

VGA



#### Features & Benefits:

- Receives computer video, stereo audio, and control signals over a single twisted pair cable, such as Cat 5e or Cat 6
- Dual amplified outputs and adjustable video equalization
- Can pass resolutions up to 1920x1200 and 20 Hz to 20 kHz audio up to 350 feet
- Bi-directional IR and RS232 extension up to 350 feet
- Receiver only - compatible transmitter required

#### Application:

- Receive computer video, audio, and control signals from up to 350 feet away
- Can be used in point-to-point or point-to-many configurations
- Ideal for corporate facilities, churches, schools, and conference centers



#### CATEGORY PATCH CABLES

Top quality reliable options for any type of installation

See Page: 92

MAX DISTANCE: 350 FEET

COMPATIBLE DEVICES: DIGI-VGASD2-S, DIGI-VGASD2-T4, DIGI-VGASD2-T8

## VGA DISTRIBUTION AMP - 1 INPUT X 4 OUTPUT

### VGA2-DA4

VGA



#### Features & Benefits:

- Supports resolutions up to 2560x1600
- High fidelity 20 Hz to 20 kHz audio
- Supports DDC (output 1 only)
- Amplifiers may be cascaded (signal degradation will occur if there are too many links from the first DA)
- Max resolution: 2560x1600

#### Application:

- Distribute a computer video and audio signal to four destinations
- Ideal for corporate facilities, churches, schools, and conference centers

MAX DISTANCE: 5 METERS WITH LIBERTY CABLES, LONGER DISTANCES WITH INTELIX EXTENDERS

COMPATIBLE DEVICES: COMPATIBLE DEVICES: VGA SOURCES, VGA DISPLAY DEVICES

## VGA DISTRIBUTION AMP - 1 INPUT X 2 OUTPUT

### VGADA-2

VGA



#### Features & Benefits:

- Supports resolutions up to 2048x1536
- Supports DDC (output 1 only)
- Signal bandwidth: 300 MHz
- Amplifiers may be cascaded (signal degradation will occur if there are too many links from the first DA)
- Max resolution: 2048x1536

#### Application:

- Distribute a computer video and audio signal to four destinations
- Ideal for corporate facilities, churches, schools, and conference centers



#### VGA CABLES

Reliable options for any professional installation

See Page 109

MAX DISTANCE: 5 METERS WITH LIBERTY CABLES, LONGER DISTANCES WITH INTELIX EXTENDERS

COMPATIBLE DEVICES: VGA SOURCES, VGA DISPLAY DEVICES

## BROADBAND VIDEO BALUN

Cable TV

RF-F



MALE F-TYPE END

RJ45 END



Scan QR code to save a text link to detailed specs, info, & available training videos

### Features & Benefits:

- Male F-type to RJ45 connectivity
- Transmits video and audio up to 330 feet
- Supports CATV channels 2-150, VHF channels 2-13
- Supports FM broadcast band
- Used in pairs

### Application:

- Private RF networks, guestroom TV and internet services
- Apartments and condominiums, schools and universities, and corporate audio-visual environments

MAX DISTANCE: 330 FEET

COMPATIBLE DEVICES: N/A

## COMPONENT VIDEO & DIGITAL AUDIO BALUN

Component Video

AVO-V3AD-F



FRONT



BACK



Scan QR code to save a text link to detailed specs, info, & available training videos

### Features & Benefits:

- Four female RCA to one RJ45 connectivity
- Transmits/receives one component video signal and one digital multi-channel audio signal
- Up to 1,000 feet cable lengths on S/UTP category 5/5e/6
- This is one unit, two units needed to complete the circuit
- Audio bandwidth: 25 MHz, 1 dB roll off
- Video bandwidth: 60 MHz, 3 dB roll off

### Application:

- Ideal for corporate facilities, churches, schools, auditoriums and almost any other situation involving component video and audio signal distribution
- Long distance routing of component video and digital audio up to 1,000 feet over structured cabling such as Cat5
- Used in pairs, these baluns replace bulky coax cable and utilize a building's existing structured cabling network

MAX DISTANCE: 480I/P: 1,000 FEET; 720P: 600 FEET; 1080I/P: 500 FEET

COMPATIBLE DEVICES: AVO-V3AD-WP-F, AVO-V3AD-110

## COMPONENT VIDEO & DIGITAL AUDIO WALL PLATE BALUN

Component Video

AVO-V3AD-WP-F



**WebBlox**  
CUSTOMIZE YOUR PLATES  
WITH PANELCRAFTERS  
[www.LibAV.com](http://www.LibAV.com)



Scan QR code to save a text link to detailed specs, info, & available training videos

### Features & Benefits:

- Four female RCA to one RJ45 connectivity
- Transmits/receives one component video signal and one digital multi-channel audio signal
- Up to 1,000 feet cable lengths on S/UTP category 5/5e/6
- This is one unit, two units needed to complete the circuit
- Audio bandwidth: 25 MHz, 1 dB roll off
- Video bandwidth: 60 MHz, 3 dB roll off

### Application:

- Ideal for corporate facilities, churches, schools, auditoriums and almost any other situation involving component video and audio signal distribution
- Long distance routing of component video and digital audio up to 1,000 feet over structured cabling such as Cat5
- Used in pairs, these baluns replace bulky coax cable and utilize a building's existing structured cabling network

MAX DISTANCE: 480I/P: 1,000 FEET; 720P: 600 FEET; 1080I/P: 500 FEET

COMPATIBLE DEVICES: AVO-V3AD-F, AVO-V3AD-110

## COMPONENT VIDEO & DIGITAL AUDIO WALL PLATE BALUN - 110 PUNCH DOWN BLOCK

Component Video

AVO-V3AD-WP110



**WebBlox**  
CUSTOMIZE YOUR PLATES  
WITH PANELCRAFTERS  
[www.LibAV.com](http://www.LibAV.com)

### Features & Benefits:

- Four female RCA to 110 punch down block connectivity
- Transmits/receives one component video signal and one digital multi-channel audio signal
- Up to 1,000 feet cable lengths on S/UTP category 5/5e/6
- This is one unit, two units needed to complete the circuit
- Audio bandwidth: 25 MHz, 1 dB roll off
- Video bandwidth: 60 MHz, 3 dB roll off

### Application:

- Ideal for corporate facilities, churches, schools, auditoriums and almost any other situation involving component video and audio signal distribution
- Long distance routing of component video and digital audio up to 1,000 feet over structured cabling such as Cat5
- Used in pairs, these baluns replace bulky coax cable and utilize a building's existing structured cabling network

MAX DISTANCE: 480I/P: 1,000 FEET; 720P: 600 FEET; 1080I/P: 500 FEET

COMPATIBLE DEVICES: AVO-V3AD-F, AVO-V3AD-WP-F

## COMPONENT VIDEO BALUN

Component Video

AVO-V3HD-F



Scan QR code to save a text link to detailed specs, info, & available training videos

### Features & Benefits:

- Three female BNC to one RJ45 connectivity
- Transmits/receives one component video signal
- Up to 500 feet cable lengths on S/UTP category 5/5e/6
- This is one unit, two units needed to complete the circuit
- Video bandwidth: 60 MHz, 3 dB roll off

### Application:

- Ideal for corporate facilities, churches, schools, auditoriums and almost any other situation involving component video signal distribution
- Long distance routing of component video up to 500 feet over structured cabling such as Cat5
- Used in pairs, these baluns replace bulky coax cable and utilize a building's existing structured cabling network

MAX DISTANCE: 500 FEET

COMPATIBLE DEVICES: COMPONENT VIDEO SOURCES AND DISPLAY DEVICES

## COMPONENT VIDEO & IR BALUN

Component Video

AVO-V3PT-F



Scan QR code to save a text link to detailed specs, info, & available training videos

### Features & Benefits:

- Three female RCA and one spring tension (two conductor) to one RJ45 connectivity
- Transmits/receives one component video signal and IR commands
- Up to 1,000 feet cable lengths on S/UTP category 5/5e/6
- This is one unit, two units needed to complete the circuit
- Video bandwidth: 60 MHz, 3 dB roll off

### Application:

- Ideal for corporate facilities, churches, schools, auditoriums and almost any other situation involving component video signal distribution
- Long distance routing of component video and IR commands up to 1,000 feet over structured cabling such as Cat5
- Used in pairs, these baluns replace bulky coax cable and utilize a building's existing structured cabling network



**CATEGORY PATCH CABLES**  
Top quality reliable options  
for any type of installation  
See Page: 92

MAX DISTANCE: 480I/P: 1,000 FEET; 720P: 500 FEET; 1080I/P: 500 FEET

COMPATIBLE DEVICES: COMPONENT VIDEO SOURCES AND DISPLAY DEVICES

## COMPOSITE VIDEO BALUNS - PAIR

AVO-V1-PAIR-F

### Component Video



#### Features & Benefits:

- One male BNC to one RJ45 connectivity
- Transmits/receives one composite video signal
- Up to 2,500 feet cable lengths on S/UTP category 5/5e/6
- Video bandwidth: DC to 8 MHz
- Sold in pairs

#### Application:

- Ideal for corporate facilities, churches, schools, auditoriums and almost any other situation involving composite video signal distribution
- Long distance routing of composite video up to 2,500 feet over structured cabling such as Cat5
- Used in pairs, these baluns replace bulky coax cable and utilize a building's existing structured cabling network

MAX DISTANCE: 2,200 FEET COLOR; 2,500 FEET BLACK AND WHITE

COMPATIBLE DEVICES: AVO-V1-WP-F, AVDA-8-F

## COMPOSITE VIDEO WALL PLATE BALUN

AVO-V1-WP-F

### Composite Video



**WebBlox**  
CUSTOMIZE YOUR PLATES  
WITH PANELCRAFTERS  
[www.LibAV.com](http://www.LibAV.com)



#### Features & Benefits:

- One female RCA to one RJ45 connectivity
- Transmits/receives one composite video signal
- This is one unit, two units needed to complete the circuit
- Up to 2,500 feet cable lengths on S/UTP category 5/5e/6
- Video bandwidth: DC to 8 MHz

#### Application:

- Ideal for corporate facilities, churches, schools, auditoriums and almost any other situation involving composite video signal distribution
- Long distance routing of composite video up to 2,500 feet over structured cabling such as Cat5
- Used in pairs, these baluns replace bulky coax cable and utilize a building's existing structured cabling network

MAX DISTANCE: 2,200 FEET COLOR; 2,500 FEET BLACK AND WHITE

COMPATIBLE DEVICES: AVO-V1-F, AVDA-8-F

## COMPOSITE VIDEO & ANALOG STEREO AUDIO BALUN

AVO-V1A2-F

### Composite Video



#### Features & Benefits:

- Two female RCA and one female BNC to one RJ45 connectivity
- Transmits/receives one composite video signal and one analog stereo audio signal
- This is one unit, two units needed to complete the circuit
- Up to 2,200 feet cable lengths on S/UTP category 5/5e/6
- High fidelity audio 20Hz to 20 kHz
- Video bandwidth: DC to 8 MHz

#### Application:

- Ideal for corporate facilities, churches, schools, auditoriums and almost any other situation involving composite video and audio signal distribution
- Long distance routing of composite video and high quality stereo audio up to 2,200 feet over structured cabling such as Cat5
- Used in pairs, these baluns replace bulky coax cable and utilize a building's existing structured cabling network



**FULLY UPDATED TECH SPECS**  
For all products available online!  
[www.LibAV.com](http://www.LibAV.com)

MAX DISTANCE: 2,200 FEET

COMPATIBLE DEVICES: AVO-V1A2-WP-F, AVDA-8-F, AVO-V1A2-WP-110

## COMPOSITE VIDEO & ANALOG STEREO AUDIO WALL PLATE BALUN

AVO-V1A2-WP-F

### Composite Video



**WebBlox**  
CUSTOMIZE YOUR PLATES  
WITH PANELCRAFTERS  
[www.LibAV.com](http://www.LibAV.com)



Scan QR code to save a text link to detailed specs, info, & available training videos

### Features & Benefits:

- Three female RCA to one RJ45 connectivity
- Transmits/receives one composite video signal and one analog stereo audio signal
- This is one unit, two units needed to complete the circuit
- Up to 2,200 feet cable lengths on S/UTP category 5/5e/6
- High fidelity audio 20Hz to 20 kHz
- Video bandwidth: DC to 8 MHz

### Application:

- Ideal for corporate facilities, churches, schools, auditoriums and almost any other situation involving composite video and audio signal distribution
- Long distance routing of composite video and high quality stereo audio over structured cabling such as Cat5
- Used in pairs, these baluns replace bulky coax cable and utilize a building's existing structured cabling network

MAX DISTANCE: 2,200 FEET

COMPATIBLE DEVICES: AVO-V1A2-F, AVDA-8-F

## COMPOSITE VIDEO & ANALOG STEREO AUDIO WALL PLATE BALUN - 110 PUNCH DOWN BLOCK

AVO-V1A2-WP110

### Composite Video



**WebBlox**  
CUSTOMIZE YOUR PLATES  
WITH PANELCRAFTERS  
[www.LibAV.com](http://www.LibAV.com)



Scan QR code to save a text link to detailed specs, info, & available training videos

### Features & Benefits:

- Three female RCA to 110 punch down block connectivity
- Transmits/receives one composite video signal and one analog stereo audio signal
- This is one unit, two units needed to complete the circuit
- Up to 2,200 feet cable lengths on S/UTP category 5/5e/6
- High fidelity audio 20Hz to 20 kHz
- Video bandwidth: DC to 8 MHz

### Application:

- Ideal for corporate facilities, churches, schools, auditoriums and almost any other situation involving composite video and audio signal distribution
- Long distance routing of composite video and high quality stereo audio up to 2,200 feet over structured cabling such as Cat5
- Used in pairs, these baluns replace bulky coax cable and utilize a building's existing structured cabling network

MAX DISTANCE: 2,200 FEET

COMPATIBLE DEVICES: AVO-V1A2-F, AVDA-8-F, AVO-V1A2-WP-F

## DUAL COMPOSITE VIDEO & ANALOG STEREO AUDIO BALUN

AVO-SVA2-F

### Composite Video



FRONT

BACK



Scan QR code to save a text link to detailed specs, info, & available training videos

### Features & Benefits:

- Four female RCA to one RJ45 connectivity
- Transmits/receives one s-video signal and one analog stereo audio signal
- Up to 2,200 feet cable lengths on S/UTP category 5/5e/6
- This is one unit, two units needed to complete the circuit
- High fidelity audio 20Hz to 20 kHz
- Video bandwidth: DC to 8 MHz

### Application:

- Ideal for corporate facilities, churches, schools, auditoriums and almost any other situation involving s-video and audio signal distribution
- Long distance routing of two composite video and high quality stereo audio up to 2,200 feet over structured cabling such as Cat5
- Used in pairs, these baluns replace bulky coax cable and utilize a building's existing structured cabling network
- Transmit one s-video, as well as one stereo or two mono signals in the same or opposite directions

MAX DISTANCE: 2,200 FEET

COMPATIBLE DEVICES: AVDA-8-F, AVO-SV1A2-WP-F

## DUAL COMPOSITE VIDEO & ANALOG STEREO AUDIO WALL PLATE BALUN

### Composite Video



FRONT

BACK

## AVO-SVA2-WP-F



**WebBlox**  
**CUSTOMIZE YOUR PLATES**  
**WITH PANELCRAFTERS**  
[www.LibAV.com](http://www.LibAV.com)

### Features & Benefits:

- Four female RCA to one RJ45 connectivity
- Transmits/receives one s-video signal and one analog stereo audio signal
- Up to 2,200 feet cable lengths on S/UTP category 5/5e/6
- This is one unit, two units needed to complete the circuit
- High fidelity audio 20Hz to 20 kHz
- Video bandwidth: DC to 8 MHz

### Application:

- Ideal for corporate facilities, churches, schools, auditoriums and almost any other situation involving s-video and audio signal distribution
- Long distance routing of one s-video and high quality stereo audio up to 2,200 feet over structured cabling such as Cat5
- Used in pairs, these baluns replace bulky coax cable and utilize a building's existing structured cabling network
- Transmit one s-video, as well as one stereo or two mono signals in the same or opposite directions

MAX DISTANCE: 2,200 FEET

COMPATIBLE DEVICES: AVDA-8-F, AVO-SVA2-F

## COMPOSITE VIDEO, CONTROL & POWER BALUN

### Composite Video



APPROXIMATELY 4.5"

## S-V1CP



Scan QR code to save a text link to detailed specs, info, & available training videos

### Features & Benefits:

- Video, control, and power over a single cable
- Paralleled male and female DIN power connectors
- Video up to 1,000 feet passively
- Power up to 650 feet
- Supports "up-the-coax" PTZ control signals
- Used in pairs

### Application:

- Transmits/receives composite video, control, and power up to 1,000 feet
- Ideal for surveillance camera systems



**BARGAIN BIN!**  
**PRICES DROP DAILY**  
 Check back daily for lower prices on overstock items!  
[www.LibAV.com](http://www.LibAV.com)

MAX DISTANCE: VIDEO: 1,000 FEET; POWER: 650 FEET; CONTROL: 1,000 FEET

COMPATIBLE DEVICES: S-V1ST, S-V1P-R, S-V1P-T

## COMPOSITE VIDEO & POWER RECEIVER

### Composite Video



APPROXIMATELY 4.5"

## S-V1P-R



Scan QR code to save a text link to detailed specs, info, & available training videos

### Features & Benefits:

- Video and power over a single cable
- Female DIN power connector
- Video up to 1,000 feet passively
- Power up to 650 feet
- Supports "up-the-coax" PTZ control signals

### Application:

- Receives composite video up to 1,000 feet and power up 650 feet
- Ideal for surveillance camera systems



**New Website**  
[www.LibAV.com](http://www.LibAV.com)  
**BETTER. STRONGER. EXPANSIVE!**

MAX DISTANCE: VIDEO: 1,000 FEET; POWER: 650 FEET

COMPATIBLE DEVICES: -V1ST, S-V1P-T, S-V1P

## COMPOSITE VIDEO & POWER TRANSMITTER

S-V1P-T

### Composite Video

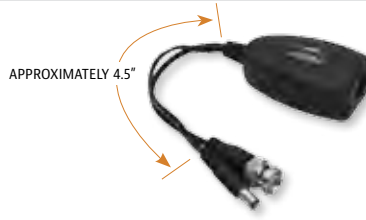

Scan QR code to save a text link to detailed specs, info, & available training videos

#### Features & Benefits:

- Video and power over a single cable
- Male DIN power connector
- Video up to 1,000 feet passively
- Power up to 650 feet
- Supports "up-the-coax" PTZ control signals

#### Application:

- Transmits composite video up to 1,000 feet and power up 650 feet
- Ideal for surveillance camera systems



**FULLY UPDATED TECH SPECS**  
For all products available online!  
[www.LibAV.com](http://www.LibAV.com)

MAX DISTANCE: VIDEO: 1,000 FEET; POWER: 650 FEET

COMPATIBLE DEVICES: S-V1ST, S-V1P-R, S-V1CP

## COMPOSITE VIDEO BALUN

S-V1ST

### Composite Video



#### CUSTOMER SERVICE

We offer technical assistance on all of our products or applications!  
Call us at 800-530-899 or email:  
[orders@LibAV.com](mailto:orders@LibAV.com)



Scan QR code to save a text link to detailed specs, info, & available training videos

#### Features & Benefits:

- Composite video up to 1,000 feet passively
- Ultra-compact design
- Quick connect screw terminal connectors
- Male BNC connector
- Supports "up-the-coax" PTZ control signals

#### Application:

- Transmits composite video up to 1,000 feet
- Ideal for surveillance camera systems

MAX DISTANCE: 1,000 FEET

COMPATIBLE DEVICES: S-V1P-R, S-V1P-T, S-V1CP

## DVI-D OVER DUAL TWISTED-PAIR EXTENDER

DIGI-DVI-F

### DVI



SOLD AS A SET



DIGI-DVI-F-R:  
DVI END



DIGI-DVI-F-S:  
DVI END



DIGI-DVI-F-R:  
TWISTED PAIR END



DIGI-DVI-F-S:  
TWISTED PAIR END



Scan QR code to save a text link to detailed specs, info, & available training videos

#### Features & Benefits:

- Transmit DVI-D up to 150 feet over two twisted pair cables
- Supports HDTV and VESA resolutions up to 1080i and 1900x1200
- Powered on either the send or receive end
- Mac compatible and HDCP compliant

#### Application:

- Medical and corporate facilities, churches, schools, auditoriums
- Any application requiring DVI-D signal extension and/or digital video with locking connectors



#### DVI CABLES

Reliable options for any professional installation  
[See Page 93](#)

MAX DISTANCE: 150 FEET OVER TWO UNSHIELDED CAT 5

COMPATIBLE DEVICES: SINGLE-LINK DVI-D SOURCES AND DISPLAYS



## HDMI OVER COAX - TRANSMITTER

HDMI - COAX

DIGI-HD-COAX2-S



COAX END



HDMI END



Scan QR code to save a text link to detailed specs, info, & available training videos

### Features & Benefits:

- 1080p up to 300 feet (92m), 1080i/720p up to 650 feet (200m)
- Linkable up to 7 units
- Stereo, 5.1 and 7.1 audio support
- HDCP compliant
- Built-in 1x2 splitter
- 10.4 Gb/s amplifier bandwidth
- Transmitters and receivers are sold individually

### Application:

- HDMI multimedia extension, plenum HDMI routing
- Digital signage, restaurant and bar
- Long distance HDMI extension (through DIGI-HD-COAX2-R daisy chaining)



**HDMI CABLES**  
Options for any type of professional installation  
See Page: 102

MAX DISTANCE: 1080P: 300 FEET RG6; 1080I/720P: 650 FEET RG6; 480I/480P: NOT SUPPORTED

COMPATIBLE DEVICES: DIGI-HD-COAX2-R

## HDMI OVER COAX - RECEIVER

HDMI - COAX

DIGI-HD-COAX2-R



COAX END



HDMI END



Scan QR code to save a text link to detailed specs, info, & available training videos

### Features & Benefits:

- 1080p up to 300 feet (92m), 1080i/720p up to 650 feet (200m)
- Linkable up to 7 units
- Stereo, 5.1 and 7.1 audio support
- HDCP compliant
- Built-in 1x2 splitter: one HDMI output, one coaxial loop output
- 10.4 Gb/s amplifier bandwidth
- Receiver only - requires DIGI-HD-COAX2-S

### Application:

- HDMI multimedia extension, plenum HDMI routing
- Digital signage, restaurant and bar
- Long distance HDMI extension (through DIGI-HD-COAX2-R daisy chaining)



**DIGITAL VIDEO BULK**  
Reliable options for any type of professional installation  
See Page: 25

MAX DISTANCE: 1080P: 300 FEET RG6; 1080I/720P: 650 FEET RG6; 480I/480P: NOT SUPPORTED

COMPATIBLE DEVICES: DIGI-HD-COAX2-S

## HDBaseT HDMI VIDEO & AUDIO EXTENDER - RECEIVER

HDMI - HDBaseT

DIGI-HD70-R



HDMI END



TWISTED PAIR END



Scan QR code to save a text link to detailed specs, info, & available training videos

### Features & Benefits:

- Extends 1080p and multichannel audio signals up to 70 meters (229 feet)
- 3D and 4K x 2K up to 40 meters (131 feet)
- EDID pass through makes for a simple and easy installation
- Compatible with FLX-8X8A HDBaseT Flex Matrix
- Supports Consumer Electronics Control
- HDMI and HDCP compliant
- Receiver only - compatible transmitter required

### Application:

- Extend HDMI up to 70 meters
- Digital signage, restaurant and bar, home theater, commercial video systems
- Supports plenum, outdoor cable formats



**UNIVERSAL MOUNTING BRACKET FOR DEVICES**  
DIGI-PMK1  
See Page: 163

MAX DISTANCE: 1080P AND MULTICHANNEL AUDIO: 229 FEET 3D AND 4K X 2K: 131 FEET

COMPATIBLE DEVICES: DIGI-HD70-S, FLX-8X8A/FLX-804

## HDBaseT HDMI VIDEO & AUDIO EXTENDER - TRANSMITTER

HDMI - HDBaseT

DIGI-HD70-S



HDMI END



TWISTED PAIR END



Scan QR code to save a text link to detailed specs, info, & available training videos

### Features & Benefits:

- Extends 1080p and multichannel audio signals up to 229 feet
- 3D and 4K x 2K up to 131 feet
- EDID pass through makes for a simple and easy installation
- Compatible with FLX-8X8A HDBaseT Flex Matrix
- Supports Consumer Electronics Control
- HDMI and HDCP compliant
- Transmitter only - compatible receiver required

### Application:

- Extend 1080p up to 229 feet, 3D and 4K x 2K up to 131 feet
- Digital signage, restaurant and bar, home theater, commercial video systems
- Supports plenum, outdoor cable formats



**HDMI MOBILE ADAPTER RING GENIUS!**

See Page: 132

MAX DISTANCE: 1080P AND MULTICHANNEL AUDIO: 229 FEET 3D AND 4K X 2K: 131 FEET

COMPATIBLE DEVICES: DIGI-HD70-R, FLX-8X8A/FLX-BI4

## HDMI 1.4 IN-LINE EXTENDER

HDMI

74-005-01



Scan QR code to save a text link to detailed specs, info, & available training videos

### Features & Benefits:

- For use at display/TV end of the cable run
- HDCP compliant
- HDMI standard speed, 1080p60 5 Gbps, 3D compatible @24hz
- No external power needed - draws power from TV/display
- Flexible pigtail design approximate length: 6"

### Application:

- Boost and equalization of HDMI after a long cable run
- Boost and equalization of DIY HD terminated cables
- Fix trouble spots caused by passive junction losses



**WORKS PERFECTLY WITH HD TERMINATION SYSTEM**

See Page 30

MAX DISTANCE:

COMPATIBLE DEVICES:

# HD TERMINATION SYSTEM CUSTOMIZABLE HD CABLE LENGTHS!



- Customize your HD cable lengths to professionally dress racks, minimize excess cable and run through small openings
- Locking HDMI connector technology increases retention up to 400%
- Supports HDMI with ethernet, CEC and bi-directional audio formats

See Page: 30



**TERMINATE IN 5 MINUTES!**



## HDBaseT HDMI, ETHERNET, RS232 & BI-DIRECTIONAL IR EXTENDER - RECEIVER

### DIGI-HDE-R

HDMI - HDBaseT



RS232 & TWISTED PAIR END



HDMI & ETHERNET END



Scan QR code to save a text link to detailed specs, info, & available training videos

#### Features & Benefits:

- Receive unit with power supply and manual
- Up to 100m (328 ft.) extension of HDMI multimedia, 100BaseT ethernet, bi-directional IR and RS232
- Supports 3D, 4K x 2K, most audio formats up to 7.1 channel audio
- HDMI and HDCP compliance
- Includes mounting ears

#### Application:

- Extend HDMI up to 100 meters, plenum and non-plenum
- Digital signage, home theater, commercial video systems
- Supports plenum, outdoor cable formats



#### CUSTOMER SERVICE

We offer technical assistance on all of our products or applications! Call us at 800-530-899 or email: [orders@LibAV.com](mailto:orders@LibAV.com)

MAX DISTANCE: 100M (328')

COMPATIBLE DEVICES: DIGI-HDE-S, FLX-8X8A/FLX-BO4 (UP TO 70M, NO ETHERNET)

## HDBaseT HDMI, ETHERNET, RS232 & BI-DIRECTIONAL IR EXTENDER - TRANSMITTER

### DIGI-HDE-S

HDMI - HDBaseT



RS232 & TWISTED PAIR END



HDMI & ETHERNET END



Scan QR code to save a text link to detailed specs, info, & available training videos

#### Features & Benefits:

- Receive unit with power supply and manual
- Up to 100m (328 ft.) extension of HDMI multimedia, 100BaseT ethernet, bi-directional IR and RS232
- Supports 3D, 4K x 2K, most audio formats up to 7.1 channel audio
- HDMI and HDCP compliance
- Includes mounting ears

#### Application:

- Extend HDMI up to 100 meters, plenum and non-plenum
- Digital signage, home theater, commercial video systems
- Supports plenum, outdoor cable formats

MAX DISTANCE: 100M (328')

COMPATIBLE DEVICES: DIGI-HDE-R, FLX-8X8A/FLX-BI4 (UP TO 70M, NO ETHERNET)

# TRY & BUY DEMO PROGRAM GET TREMENDOUS SAVINGS ON NEW INTELIX PRODUCTS!



## TALK TO YOUR REP TODAY TO FIND OUT HOW TO TAKE ADVANTAGE OF THE INTELIX TRY & BUY DEMO PROGRAM— GREAT SAVINGS AND RISK FREE!

Intelix products are available to Liberty dealers on an introductory basis at tremendous savings! Demo new items for 60 days RISK-FREE and purchase products at great savings off standard dealer pricing. Each Intelix SKU qualifies for a one-time single unit discounted purchase.

## LIBERTY DIGITALINX™ TWIN CATEGORY CABLE HDMI 1.4 RECEIVER

HDMI Traditional Cat 5 **DIGITALINX™**



### Features & Benefits:

- HDMI 1.4, Simplay Certified
- Supports 6.75 Gbps 1080p60 deep Color, 3D, ARC, Ethernet
- Supports All Audio formats
- Recommend Category 6 Overall Shielded TWP Cables

### DL-HDCAT-R

#### Application:

- Extension of HDMI/DVI signals
- Plenum longer distance HDMI/DVI Extension
- Small space issues where TWP can be run but not HDMI"



**LOCKING HDMI**  
When you lose connectivity you lose business!  
See Page: 104

MAX DISTANCE: 50M (165 FEET) 1080P ON CATEGORY 6; 30M (100 FEET) 1080P OF CATEGORY 5E

## LIBERTY DIGITALINX™ TWIN CATEGORY CABLE HDMI 1.4 WALL PLATE RECEIVER

HDMI Traditional Cat 5 **DIGITALINX™**



### Features & Benefits:

- HDMI 1.4, Simplay Certified
- Supports 6.75 Gbps 1080p60 deep Color, 3D, ARC, Ethernet
- Supports All Audio formats
- Recommend Category 6 Overall Shielded TWP Cables

### DL-HDCAT-WP-R

#### Application:

- Extension of HDMI/DVI signals
- Plenum longer distance HDMI/DVI Extension
- Small space issues where TWP can be run but not HDMI"

MAX DISTANCE: 50M (165 FEET) 1080P ON CATEGORY 6; 30M (100 FEET) 1080P OF CATEGORY 5E

## LIBERTY DIGITALINX™ TWIN CATEGORY CABLE HDMI 1.4 TRANSMITTER

HDMI Traditional Cat 5 **DIGITALINX™**



### Features & Benefits:

- HDMI 1.4, Simplay Certified
- Supports 6.75 Gbps 1080p60 deep Color, 3D, ARC, Ethernet
- Supports All Audio formats
- Recommend Category 6 Overall Shielded TWP Cables

### DL-HDCAT-S

#### Application:

- Extension of HDMI/DVI signals
- Plenum longer distance HDMI/DVI Extension
- Small space issues where TWP can be run but not HDMI



**CATEGORY PATCH CABLES**  
Top quality reliable options for any type of installation  
See Page: 92

MAX DISTANCE: 50M (165 FEET) 1080P ON CATEGORY 6; 30M (100 FEET) 1080P OF CATEGORY 5E

## LIBERTY DIGITALINX™ TWIN CATEGORY CABLE HDMI 1.4 WALL PLATE TRANSMITTER

HDMI Traditional Cat 5 **DIGITALINX™**



### Features & Benefits:

- HDMI 1.4, Simplay Certified
- Supports 6.75 Gbps 1080p60 deep Color, 3D, ARC, Ethernet
- Supports All Audio formats
- Recommend Category 6 Overall Shielded TWP Cables
- 50m (165 feet) 1080p on Category 6
- 30m (100 feet) 1080p of Category 5e
- Package includes Wall Plate Mounted TX unit only

### DL-HDCAT-WP-S

#### Application:

- Extension of HDMI/DVI signals
- Plenum longer distance HDMI/DVI Extension
- Small space issues where TWP can be run but not HDMI

MAX DISTANCE: 50M (165 FEET) 1080P ON CATEGORY 6; 30M (100 FEET) 1080P OF CATEGORY 5E

# UNIVERSAL MOUNTING BRACKET

Designed with Multiple Patterns and Holes for Flexibility in Mounting



The Intelix DIGI-PMK1 is an ideal accessory for mounting DIGI-HD70 extenders, as well as a variety of other Intelix products. The convenient design provides snap-in security and can be mounted to a variety of surfaces, including racks, walls, poles, under tables and countertops, and to the rear of displays.



Example of device in bracket



Side view of device in bracket



Quick device insertion and release



Scan to go directly to video

## DIGI-PMK1

### Features and Benefits

- VESA75 mounting pattern
- Unbreakable molded plastic
- Snap-in securing and release
- 10 per box

### Applications

- For Intelix 110x75 chassis device mounting on poles, walls, racks, TVs and VESA75
- Fits Intelix DIGI and AVO devices:  
DIGI-HD70-S, DIGI-HD70-R, DIGI-HD60C-S, DIGI-HD60C-R, AVO-VGA-S, AVO-VGA-R, DIGI-HD-IR3-S, DIGI-HD-IR3-R, DIGI-HD-UHR2-S, DIGI-HD-UHR2-R

### Tech Specs

#### PART NUMBER

DIGI-PMK1

#### COMPATIBLE DEVICES

DIGI-HD70-S, DIGI-HD70-R, DIGI-HD60C-S, DIGI-HD60C-R, AVO-VGA-S, AVO-VGA-R, DIGI-HD-IR3-S, DIGI-HD-IR3-R, DIGI-HD-UHR2-S, DIGI-HD-UHR2-R

#### MATERIAL

ABS Plastic – Gloss Black

#### DIMENSIONS (WITHOUT DEVICE)

110.5mm (H) x 75.6mm (W) x 21mm (D)  
(4-5/16" x 3-1/8" x 7/8")

#### DIMENSIONS (WITH DEVICE)

110.5mm (H) x 75.6mm (W) x 21mm (D)  
(4-5/16" x 3-1/8" x 1-1/4")

#### SHIPPING WEIGHT

1lbs. (0.45kg) (Box of [10] DIGI-PMK1)

#### WHAT'S IN THE BOX

(1) DIGI-PMK1 (hardware not included)



USING DIGI-PMK1 TO MOUNT A DEVICE TO A POLE



USING DIGI-PMK1 TO MOUNT A DEVICE TO A RACK



USING DIGI-PMK1 TO MOUNT A DEVICE TO A WALL



USING DIGI-PMK1 TO MOUNT A DEVICE TO A TELEVISION



## HDMI IN-LINE EQUALIZER AND BOOSTER WITH POWER SUPPLY

DL-HDR

HDMI

**DIGITALINX™**



Scan QR code to save a text link to detailed specs, info, & available training videos

### Features & Benefits:

- 2.25 Gbps per channel = 6.75 Gbps data rate
- Supports 1080p60, deep color, 3D
- Does not support ethernet, bi-directional audio
- Supports receivers, extenders
- HDCP compliant, HDMI 1.3 compliant
- Use only at the end of the cable run closest to the sink

### Application:

- HDMI extension
- HDMI equalization and boost after a long cable run
- Repair of signal after passive junction losses



### HDMI CABLES

Options for any type of professional installation  
See Page: 102

MAX LENGTH: 100 FT

COMPATIBLE DEVICES: NA

## HDMI & IR OVER TWISTED-PAIR EXTENDER - RECEIVER

DIGI-HD-IR3-R

HDMI - Traditional Cat 5



TWISTED PAIR END



HDMI END



Scan QR code to save a text link to detailed specs, info, & available training videos

### Features & Benefits:

- Extends HDMI and bi-directional IR up to 300 feet (720p/1080i)
- 1080p up to 150 feet with shielded Cat6
- Bi-directional wideband IR
- Built-in surge protection
- Configurable EDID
- HDMI and HDCP compliant
- Receiver only - compatible transmitter required

### Application:

- Extend 1080p up to 150 feet, 1080i/720p up to 300 feet
- Digital signage, restaurant and bar, home theater, commercial video systems
- Supports plenum, outdoor cable formats

MAX DISTANCE: CAT 5E: 1080P @ 30M/100 FT; 720P/1080I @ 200 FT; CAT 6: 1080P @ 45M/150 FT; 720P/1080I @ 300 FT.

COMPATIBLE DEVICES: DIGI-HD-1X4, DIGI-HD-1X8, DIGI-HD-4X2, DIGI-HD-4X4, DIGI-HD-4X8, DIGI-HD-8X8, DIGI-HD-XR, DIGI-HD-IR3-S, DIGI-HD-IR3-WP-S

## HDMI & IR OVER TWISTED-PAIR EXTENDER - TRANSMITTER

DIGI-HD-IR3-S

HDMI - Traditional Cat 5



TWISTED PAIR END



HDMI END



Scan QR code to save a text link to detailed specs, info, & available training videos

### Features & Benefits:

- Extends HDMI and bi-directional IR up to 300 feet (720p/1080i)
- 1080p up to 150 feet with shielded Cat6
- Bi-directional wideband IR
- Built-in surge protection
- Configurable EDID
- HDMI and HDCP compliant
- Transmitter only - compatible receiver required

### Application:

- Extend 1080p up to 150 feet, 1080i/720p up to 300 feet
- Digital signage, restaurant and bar, home theater, commercial video systems
- Supports plenum, outdoor cable formats



### CATEGORY CABLE

Options for any type of professional installation  
See Page: 17

MAX DISTANCE: CAT 5E: 1080P @ 30M/100 FT; 720P/1080I @ 200 FT; CAT 6: 1080P @ 45M/150 FT; 720P/1080I @ 300 FT.

COMPATIBLE DEVICES: DIGI-HD-IR3-R, DIGI-HD-IR3-WP-R

## HDMI & BI-DIRECTIONAL IR WALL PLATE EXTENDER - RECEIVER

DIGI-HD-IR3-WP-R

HDMI -  
Traditional Cat 5



FRONT



BACK



Scan QR code to save a text link to detailed specs, info, & available training videos

### Features & Benefits:

- Extends HDMI and bi-directional IR up to 300 feet (720p/1080i)
- 1080p up to 150 feet with shielded Cat6
- Bi-directional wideband IR
- Built-in surge protection
- Configurable EDID
- HDMI and HDCP compliant
- Receiver only - compatible transmitter required
- Mounts in a standard double gang wallbox

### Application:

- Extend 1080p video and IR up to 150 feet, 1080i/720p up to 300 feet
- Digital signage, restaurant and bar, home theater, commercial video systems
- Supports plenum, outdoor cable formats



**New Website**  
[www.LibAV.com](http://www.LibAV.com)  
**BETTER, STRONGER, EXPANSIVE!**

**MAX DISTANCE:** CAT 5E: 1080P @ 30M/100 FT.; 720P/1080I @ 200 FT.; CAT 6: 1080P @ 45M/150 FT.; 720P/1080I @ 300 FT.

**COMPATIBLE DEVICES:** DIGI-HD-1X4, DIGI-HD-1X8, DIGI-HD-4X2, DIGI-HD-4X4, DIGI-HD-4X8, DIGI-HD-8X8, DIGI-HD-IR3-WP-S, DIGI-HD-IR3-S

## HDMI & BI-DIRECTIONAL IR WALL PLATE EXTENDER - TRANSMITTER

DIGI-HD-IR3-WP-S

HDMI -  
Traditional Cat 5



FRONT



BACK



**WebBlox**  
**CUSTOMIZE YOUR PLATES WITH PANELCRAFTERS**  
[www.LibAV.com](http://www.LibAV.com)

### Features & Benefits:

- Extends HDMI and bi-directional IR up to 300 feet (720p/1080i)
- 1080p up to 150 feet with shielded Cat6
- Bi-directional wideband IR
- Built-in surge protection
- Configurable EDID
- HDMI and HDCP compliant
- Transmitter only - compatible receiver required
- Mounts in a standard double gang wallbox

### Application:

- Extend 1080p video and IR up to 150 feet, 1080i/720p up to 300 feet
- Digital signage, restaurant and bar, home theater, commercial video systems
- Supports plenum, outdoor cable formats

**MAX DISTANCE:** CAT 5E: 1080P @ 30M/100 FT.; 720P/1080I @ 200 FT.; CAT 6: 1080P @ 45M/150 FT.; 720P/1080I @ 300 FT.

**COMPATIBLE DEVICES:** DIGI-HD-IR3-R, DIGI-HD-IR3-WP-R, DIGI-HD-XR

## HDMI OVER SINGLE TWISTED-PAIR EXTENDER - RECEIVER

DIGI-HD-UHR2-R

HDMI -  
Traditional Cat 5



HDMI END



TWISTED PAIR END



Scan QR code to save a text link to detailed specs, info, & available training videos

### Features & Benefits:

- Receive unit only - includes power supply and manual
- HDMI and HDCP compliant
- HDshāk® patented signal management processing
- 1080p / 1080i / 3D compatible / all HDMI audio
- HDMI Video/Audio over 1 twisted pair cable

### Application:

- HDMI multimedia extension, plenum HDMI routing
- Digital signage, restaurant and bar, residential HDMI
- Supports plenum, outdoor cable formats



**HDMI MOBILE ADAPTER RING GENIOUS!**

See Page: 132

**MAX DISTANCE:** MAX DISTANCE: CAT5E: 30M / 100FT 1080P; CAT6A (SHIELDED): 45M / 150 FT 1080P

**COMPATIBLE DEVICES:** DIGI-HD-UHR2-S, DIGI-HD-1X4, DIGI-HD-1X8, DIGI-HD-4X2, DIGI-HD-4X4, DIGI-HD-4X8, DIGI-HD-8X8, DIGI-HD-XR

## DIGI-HD-UHR2-S

HDMI -  
Traditional Cat 5



HDMI END



TWISTED PAIR END



Scan QR code to save a text link to detailed specs, info, & available training videos

### Features & Benefits:

- Extends HDMI video and audio up to 300 feet
- 1080p up to 150 feet with shielded Cat6
- Built-in surge protection
- Configurable EDID
- HDMI and HDCP compliant
- Transmitter only - compatible receiver required

### Application:

- Extend 1080p up to 150 feet, 1080i/720p up to 300 feet
- Digital signage, restaurant and bar, home theater, commercial video systems
- Supports plenum, outdoor cable formats



**LOCKING HDMI**  
When you lose connectivity  
you lose business!  
See Page: 104

**MAX DISTANCE:** 1080P 3D: 66 FEET, 1080P: 100 FEET, 1080i/720P: 200 FEET, 480i/480P/576i/576P: 200 FEET

**COMPATIBLE DEVICES:** DIGI-HD-UHR2-WP-R, DIGI-HD-UHR2-R, DIGI-HD-XR

## HDMI OVER SINGLE TWISTED-PAIR WALL PLATE EXTENDER - RECEIVER

HDMI -  
Traditional Cat 5



FRONT



BACK



Scan QR code to save a text link to detailed specs, info, & available training videos

### Features & Benefits:

- Extends HDMI video and audio up to 300 feet of category 6 cable (720p/1080i)
- 1080p up to 150 feet with shielded Cat6
- Built-in surge protection
- Configurable EDID
- HDMI and HDCP compliant
- Transmitter only - compatible receiver required
- Mounts in a standard double gang wallbox

### Application:

- Extend 1080p up to 150 feet, 1080i/720p up to 300 feet
- Digital signage, restaurant and bar, home theater, commercial video systems
- Supports plenum, outdoor cable formats



**HDMI MOBILE  
ADAPTER RING**  
GENIUS!  
See Page: 132

**MAX DISTANCE:** CAT 5E: 1080P @ 30M/100 FT.; 720P/1080i @ 200 FT.; CAT 6: 1080P @ 45M/150 FT.; 720P/1080i @ 300 FT.

**COMPATIBLE DEVICES:** DIGI-HD-1X4, DIGI-HD-1X8, DIGI-HD-4X2, DIGI-HD-4X4, DIGI-HD-4X8, DIGI-HD-8X8, DIGI-HD-UHR2-WP-S, DIGI-HD-XR

## HDMI OVER SINGLE TWISTED-PAIR WALL PLATE EXTENDER - TRANSMITTER

HDMI -  
Traditional Cat 5



FRONT



BACK



Scan QR code to save a text link to detailed specs, info, & available training videos

### Features & Benefits:

- Extends HDMI video and audio up to 300 feet of category 6 cable (720p/1080i)
- 1080p up to 150 feet with shielded Cat6
- Built-in surge protection
- Configurable EDID
- HDMI and HDCP compliant
- Transmitter only - compatible receiver required
- Mounts in a standard double gang wallbox

### Application:

- Extend 1080p up to 150 feet, 1080i/720p up to 300 feet
- Digital signage, restaurant and bar, home theater, commercial video systems
- Supports plenum, outdoor cable formats



**WebBlox®**  
CUSTOMIZE YOUR PLATES  
WITH PANELCRAFTERS  
[www.LibAV.com](http://www.LibAV.com)

**MAX DISTANCE:** CAT 5E: 1080P @ 30M/100 FT.; 720P/1080i @ 200 FT.; CAT 6: 1080P @ 45M/150 FT.; 720P/1080i @ 300 FT.

**COMPATIBLE DEVICES:** DIGI-HD-1X4, DIGI-HD-1X8, DIGI-HD-4X2, DIGI-HD-4X4, DIGI-HD-4X8, DIGI-HD-8X8, DIGI-HD-UHR2-WP-S, DIGI-HD-XR



## HDMI & IR OVER TWISTED-PAIR EXTENDER & REPEATER

HDMI - Traditional Cat 5

DIGI-HD-XR



TWISTED PAIR OUT END



TWISTED PAIR IN END



HDMI & IR SIDE



DIP SWITCH SIDE



Scan QR code to save a text link to detailed specs, info, & available training videos

### Features & Benefits:

- Extends HDMI and IR up to 300' over Cat 5/Cat 5e/Cat 6 as an inline repeater
- Local HDMI output and IR input provides audio and video to a connected display and an IR connection point
- Compatible with most DigiCat series extenders and matrices

### Application:

- Extend signals from DigiCat series matrices and extenders beyond the 300' limit
- Ideal for residential AV, digital signage, corporate facilities, churches, and schools



**BARGAIN BIN!**  
**PRICES DROP DAILY**  
Check back daily for lower prices on overstock items!  
[www.LibAV.com](http://www.LibAV.com)

MAX DISTANCE: CAT 5E: 1080P @ 30M/100 FT.; 720P/1080I @ 200 FT.; CAT 6: 1080P @ 45M/150 FT.; 720P/1080I @ 300 FT.

COMPATIBLE DEVICES: DIGI-HD-UHR2, DIGI-HD-4X2, DIGI-HD-4X4, DIGI-HD-4X8, DIGI-HD-8X8, DIGI-HD-IR3, DIGI-HD-UHR2-WP, DIGI-HD-IR3-WP

**HDMI IS DEAD.**

“How can we say this?  
Because we have seen the future -  
and it is **HDBaseT.**”

- Audioholics Magazine

SEE PAGE 143

Intelix HDBaseT technology revolutionizes the way AV professionals distribute HDMI. Traditional HDMI distribution technology requires extensive installer configuration, limits signal bandwidth and limits transmission distance—HDBaseT removes these barriers.

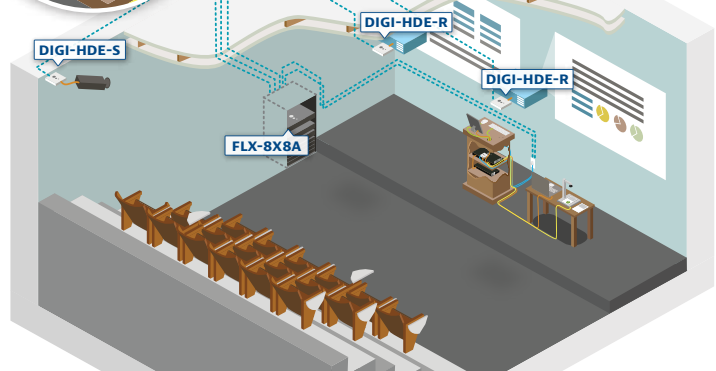
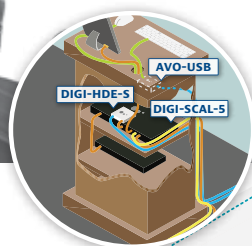

This diagram shows a common installation integrating both analog and digital equipment. Audio-visual sources are connected to an Intelix DIGI-SCAL-5 located in a podium, which is connected to an Intelix FLX-8X8A switcher via a DIGI-HDE extender set. The FLX-8X8A provides for greater signal distribution, including output routing to projectors and overflow rooms. An Intelix AVO-USB extender completes the system by routing keyboard and mouse signals from the podium to a remote PC.



**Intelix HDBaseT technology** revolutionizes the way AV professionals distribute HDMI. Traditional HDMI distribution technology requires extensive installer configuration, limits signal bandwidth and limits transmission distance—HDBaseT removes these barriers.

Intelix products are truly plug-and-play, and are rated for distribution of 1080p, 4kx2k, and 3D signals up to 330 feet. Plus, integrated multi-channel audio, Ethernet, and IR and RS232 control provide seamless integration into real-world applications.

## About Valens

Valens Semiconductor is at the heart of Intelix HDBaseT technology. Established in 2006, Valens has become the world leader in HDBaseT technology by introducing chipsets which enable HD multimedia, power and control to be transmitted exceptionally long distances.

## HDMI EXTENSION TECHNOLOGY



**DIGI-HDMI-HR-S**

**Traditional 1080i HDMI Extender**

Resolution: 1080i/720p





**DIGI-HDMI-HR-R**



**DIGI-HD-UHR2-S**

**Traditional 1080p HDMI Extender**

Resolution: 1080p





**DIGI-HD-UHR2-R**

WRONG IMAGE



**DIGI-HD70-S**

**HDBaseT-Lite Extender**

Resolution: 1080p





**DIGI-HD70-R**



**DIGI-HD-IR3-S**

**Traditional 1080p HDMI & IR Extender**

resolution: 1080p with ir

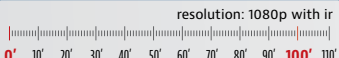



**DIGI-HD-IR3-R**



**DIGI-HDE-S**

**HDBaseT Extender**

Resolution: 1080p with IR, RS232 & Ethernet





**DIGI-HDE-R**



**DIGI-HD-COAX-S**

**HDMI over Coax Extender**

Resolution: 1080p





**DIGI-HD-COAX-R**



**SKYPLAY-HD-S**

**Wireless HDMI Extender**

resolution: 1080p





**SKYPLAY-HD-R**

## HDMI OVER TWISTED-PAIR EXTENDER SET

HDMI - Traditional Cat 5



2 DEVICES SOLD AS A SET



DIGI-HDMI-HR-R: HDMI END



DIGI-HDMI-HR-S: HDMI END



DIGI-HDMI-HR-R: TWISTED PAIR END



DIGI-HDMI-HR-S: TWISTED PAIR END

## DIGI-HDMI-HR



Scan QR code to save a text link to detailed specs, info, & available training videos

### Features & Benefits:

- Includes transmitter, receiver and power supply
- HDMI to dual RJ45 connectivity
- HDMI and HDCP compliant
- Supports 1080i, 720p, 576i/p, 480i/p
- Powered on either the send or receive unit

### Application:

- Extend 1080i/720p up to 150 feet
- Ideal for corporate facilities, churches, schools, and conference centers



### CATEGORY PATCH CABLES

Top quality reliable options for any type of installation

See Page: 92

MAX DISTANCE: 1080I UP TO 150 FEET

COMPATIBLE DEVICES: N/A

## MICROPHONE & PHANTOM POWER BALUN

Microphone Audio

## AVO-MIC-F



FRONT



BACK



### TNC & XLR CONNECTORS

See Page: 141

### Features & Benefits:

- Transmit a preamplified microphone signal and phantom power up to 2500 feet over standard twisted pair structured cabling such as Cat5 or Cat6
- High fidelity audio 20 Hz to 20 kHz
- Balun set may be powered on either the send or receive end
- Includes rack mountable send balun, rack mountable receive balun and power supply
- Mic or line level
- Doubles as a microphone preamp with 60 dB of preamplification

### Application:

- Ideal for corporate facilities, churches, schools, auditoriums and almost any other situation involving microphone audio distribution
- Long distance routing of preamplified microphone signals

MAX DISTANCE: 2,500 FEET

COMPATIBLE DEVICES: MICROPHONES, AMPLIFIERS

## MICROPHONE & PHANTOM POWER WALL PLATE SEND & MODULAR RECEIVE BALUNS

Microphone Audio

## AVO-MIC-WP-F

DEVICE & WALLPLATE SOLD AS A SET



SEND FRONT



RECEIVER FRONT



SEND BACK



RECEIVER BACK



Scan QR code to save a text link to detailed specs, info, & available training videos

### Features & Benefits:

- Transmit a preamplified microphone signal and phantom power up to 2500 feet over standard twisted pair structured cabling such as Cat5 or Cat6
- High fidelity audio 20 Hz to 20 kHz
- Balun is powered on the receive end
- Includes wall plate send balun, rack mountable receive balun and power supply

### Application:

- Ideal for corporate facilities, churches, schools, auditoriums and almost any other situation involving microphone audio distribution
- Long distance routing of preamplified microphone signals



**WebBlox**  
CUSTOMIZE YOUR PLATES WITH PANELCRAFTERS  
[www.LibAV.com](http://www.LibAV.com)

MAX DISTANCE: 2,500 FEET

COMPATIBLE DEVICES: MICROPHONES, AMPLIFIERS

# WIRELESSLY SEND HDMI SIGNALS

**EVEN THROUGH DRYWALL!**

No Line of Sight Needed



SHOWN WITH INCLUDED CRADLES



SOLD SEPARATELY

## WIRELESS HDMI RECEIVER

Wireless

## SKYPLAY-HD-R



SIDE



Scan QR code to save a text link to detailed specs, info, & available training videos

### Features & Benefits:

- Receives wireless transmission of uncompressed 1080p video and stereo audio up to 100 feet
- HDMI compliant
- Supports 480i/p, 576i/p, 720p, 1080i/p, and VESA resolutions up to 1920x1080
- Can be used as a wireless HDMI distribution amplifier - up to 20 receivers per transmitter
- Less than 3ms AV latency

### Application:

- Send HDMI signal from a source to a destination device without a wired connection
- Wireless HDMI distribution amplifier - up to 20 destinations
- Ideal for residential AV, digital signage, corporate facilities, churches, schools, and almost any application where a wired HDMI connection is not possible



**HDMI MOBILE ADAPTER RING GENIUS!**

See Page: 132

MAX DISTANCE: 100 FEET (DEPENDING ON OBSTRUCTIONS)

COMPATIBLE DEVICES: SKYPLAY-HD-S

## WIRELESS HDMI TRANSMITTER

Wireless

## SKYPLAY-HD-S



SIDE



Scan QR code to save a text link to detailed specs, info, & available training videos

### Features & Benefits:

- Transmits uncompressed 1080p video and stereo audio up to 100 feet
- HDMI compliant
- Supports 480i/p, 576i/p, 720p, 1080i/p, and VESA resolutions up to 1920x1080
- Can be used as a wireless HDMI distribution amplifier - up to 20 receivers per transmitter
- Less than 3ms AV latency

### Application:

- Send HDMI signal from a source to a destination device without a wired connection
- Wireless HDMI distribution amplifier - up to 20 destinations
- Ideal for residential AV, corporate facilities, churches, schools, conference centers, and almost any application where a wired connection is not possible



**FULLY UPDATED TECH SPECS**

For all products available online!

[www.LibAV.com](http://www.LibAV.com)

MAX DISTANCE: 100 FEET (DEPENDING ON OBSTRUCTIONS)

COMPATIBLE DEVICES: SKYPLAY-HD-R

## ANALOG STEREO AUDIO BALUN

Stereo Audio

AVO-A2-F



**THE LIBERTY**  
**EDGE** **MONEY-SAVING SERVICES!**  
Go to [www.LibAV.com](http://www.LibAV.com) or contact your rep today to make Liberty an extension of your workforce!



Scan QR code to save a text link to detailed specs, info, & available training videos

### Features & Benefits:

- 2 RCA female to RJ45 connectivity
- This is one unit, two units needed to complete the circuit
- Up to 2,500 feet cable lengths on S/UTP category 5/5e/6
- High fidelity audio 20 Hz to 20 kHz
- Compatible with AVO-A2-WP-F and AVO-A2-WP110 wall plate baluns
- Can be used to transmit/receive one stereo or two mono audio signals

### Application:

- Ideal for corporate facilities, churches, schools, auditoriums and almost any other situation involving audio signal distribution
- Long distance routing of high quality stereo or mono audio



**CUSTOMER SERVICE**  
We offer technical assistance on all of our products or applications!  
Call us at 800-530-8999 or email: [orders@LibAV.com](mailto:orders@LibAV.com)

MAX DISTANCE: 2,500 FEET

COMPATIBLE DEVICES: AVO-A2-WP-F, AVO-A2-WP110, AVDA-8-F

## ANALOG STEREO AUDIO WALL PLATE BALUN

Stereo Audio

AVO-A2-WP-F



FRONT

BACK



**WebBlox**  
CUSTOMIZE YOUR PLATES WITH PANELCRAFTERS  
[www.LibAV.com](http://www.LibAV.com)

### Features & Benefits:

- 2 RCA female to RJ45 connectivity
- This is one unit, two units needed to complete the circuit
- Up to 2,500 feet cable lengths on S/UTP category 5/5e/6
- High fidelity audio 20 Hz to 20 kHz
- Compatible with AVO-A2-F modular balun
- Can be used to transmit one stereo or two mono audio signals

### Application:

- Ideal for corporate facilities, churches, schools, auditoriums and almost any other situation involving audio signal distribution
- Long distance routing of high quality stereo or mono audio

MAX DISTANCE: 2,500 FEET

COMPATIBLE DEVICES: AVO-A2-F, AVDA-8-F, AVO-A2-WP110

## ANALOG STEREO AUDIO WALL PLATE BALUN - 110 PUNCH DOWN BLOCK

Stereo Audio

AVO-A2-WP110



FRONT

BACK



Scan QR code to save a text link to detailed specs, info, & available training videos

### Features & Benefits:

- 2 RCA female to 110 punch down block connectivity
- This is one unit, two units needed to complete the circuit
- Up to 2,500 feet cable lengths on S/UTP category 5/5e/6
- High fidelity audio 20 Hz to 20 kHz
- Compatible with AVO-A2-F modular balun
- Can be used to transmit one stereo or two mono audio signals

### Application:

- Ideal for corporate facilities, churches, schools, auditoriums and almost any other situation involving audio signal distribution
- Long distance routing of high quality stereo or mono audio



**New Website**  
[www.LibAV.com](http://www.LibAV.com)  
BETTER, STRONGER, EXPANSIVE!

MAX DISTANCE: 2,500 FEET

COMPATIBLE DEVICES: AVO-A2-F, AVDA-8-F, AVO-A2-WP-F

## ANALOG STEREO AUDIO WALL PLATE BALUN - 3.5MM

AVO-A2MINI-WP-F

Stereo Audio



FRONT

BACK



Scan QR code to save a text link to detailed specs, info, & available training videos

### Features & Benefits:

- 3.5mm female TRS to RJ45 connectivity
- This is one unit, two units needed to complete the circuit
- Transmits/receives one stereo audio signal
- Up to 2,500 feet cable lengths on S/UTP category 5/5e/6
- High fidelity audio 20 Hz to 20 kHz

### Application:

- Ideal for installations using PCs, MP3 players, and other audio devices with a 3.5mm TRS audio output
- Long distance routing of high quality stereo or mono audio



**WebBlox**  
CUSTOMIZE YOUR PLATES  
WITH PANELCRAFTERS  
[www.LibAV.com](http://www.LibAV.com)

MAX DISTANCE: 2,500 FEET

COMPATIBLE DEVICES: AVDA-8-F, AVO-A2-F, AVO-A2-WP-F, AVO-A2-WP110

## DUAL ANALOG STEREO AUDIO BALUN

AVO-A4-F

Stereo Audio



FRONT

BACK



Scan QR code to save a text link to detailed specs, info, & available training videos

### Features & Benefits:

- 4 RCA female to RJ45 connectivity
- This is one unit, two units needed to complete the circuit
- Up to 2,500 feet cable lengths on S/UTP category 5/5e/6
- High fidelity audio 20 Hz to 20 kHz

### Application:

- Ideal for corporate facilities, churches, schools, auditoriums and almost any other situation involving audio signal distribution
- Long distance routing of high quality stereo or mono audio
- Transmit two stereo, four mono, or one stereo and two mono audio signals in the same or opposite directions



**CTEC**  
AUDIO CONNECTORS  
See Page: 139

MAX DISTANCE: 2,500 FEET

COMPATIBLE DEVICES: AVO-A4-WP-F, AVO-A4-WP110

## DUAL ANALOG STEREO AUDIO WALL PLATE BALUN

AVO-A4-WP-F

Stereo Audio

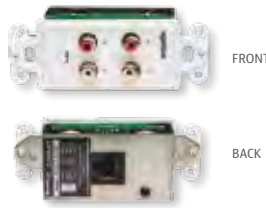

FRONT

BACK



Scan QR code to save a text link to detailed specs, info, & available training videos

### Features & Benefits:

- 4 RCA female to RJ45 connectivity
- This is one unit, two units needed to complete the circuit
- Up to 2,500 feet cable lengths on S/UTP category 5/5e/6
- High fidelity audio 20 Hz to 20 kHz

### Application:

- Ideal for corporate facilities, churches, schools, auditoriums and almost any other situation involving audio signal distribution
- Long distance routing of high quality stereo or mono audio
- Transmit two stereo, four mono, or one stereo and two mono audio signals in the same or opposite directions



**BARGAIN BIN!**  
**PRICES DROP DAILY**  
Check back daily for lower prices on overstock items!  
[www.LibAV.com](http://www.LibAV.com)

MAX DISTANCE: 2,500 FEET

COMPATIBLE DEVICES: AVO-A4-F, AVO-A4-WP110

## DUAL ANALOG STEREO AUDIO WALL PLATE BALUN - 110 PUNCH DOWN BLOCK

**AVO-A4-WP110**

### Stereo Audio



Scan QR code to save a text link to detailed specs, info, & available training videos

### Features & Benefits:

- 4 RCA female to RJ45 connectivity
- This is one unit, two units needed to complete the circuit
- Up to 2,500 feet cable lengths on S/UTP category 5/5e/6
- High fidelity audio 20 Hz to 20 kHz

### Application:

- Ideal for corporate facilities, churches, schools, auditoriums and almost any other situation involving audio signal distribution
- Long distance routing of high quality stereo or mono audio
- Transmit two stereo, four mono, or one stereo and two mono audio signals in the same or opposite directions

**MAX DISTANCE:** 2,500 FEET

**COMPATIBLE DEVICES:** AVO-A4-F, AVO-A4-WP-F

## PASSIVE VGA & ANALOG STEREO AUDIO WALL PLATE BALUN

**AVO-VGA2-WP**

### Stereo Audio

SOLD AS A SET OR SEPARATELY

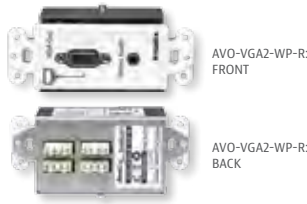

Scan QR code to save a text link to detailed specs, info, & available training videos

### Features & Benefits:

- One VGA and one 3.5mm TRS to 110 punch down block connectivity
- Transmits/receives one VGA video and one analog stereo audio signal
- Up to 450 feet cable lengths on S/UTP category 5/5e/6
- includes both transmit and receive extender - both units needed to complete the circuit
- Audio bandwidth: 20 Hz to 20 kHz
- Video bandwidth: DC to 60 MHz

### Application:

- Ideal for corporate facilities, churches, schools, auditoriums and almost any other situation involving VGA video and analog stereo audio signal distribution
- Long distance routing of VGA video and analog stereo audio up to 450 feet over structured cabling such as Cat5
- Used in pairs, these baluns replace bulky coax cable and utilize a building's existing structured cabling network

**MAX DISTANCE:** XGA: 1024 X 768 (35 MHZ) @ 200FT (61M) SXGA: 1280 X 1024 (59 MHZ) @ 100FT (30.5M)

**COMPATIBLE DEVICES:** AVO-VGA, AVO-A2-F, AVO-A2MINI-WP-F, AVO-A2-WP-F, AVO-A2-WP110

## USB 2.0 FULL-SPEED USB TWISTED PAIR EXTENDER SET

**AVO-USB**

### USB

2 DEVICES SOLD AS A SET



Scan QR code to save a text link to detailed specs, info, & available training videos

### Features & Benefits:

- USB 2.0 full speed 12Mbps, USB 1.1 legacy support
- Up to 330 feet cable lengths on S/UTP category 5/5e/6
- Not for USB 2.0 high speed
- No external power required, uses host device's 5V power
- USB "A" male (host), USB "A" female (client) to RJ45 jack connectivity
- Sold in pairs

### Application:

- Uses any Cat5/5e/6/6A twisted pair cabling
- Extension of USB 1.1 and 2.0 full speed signals
- Plenum routing of USB 1.1 and 2.0 full speed
- Ideal for education, government, house of worship, corporate, residential, and any other application requiring extended USB signal distribution



**USB CABLES**  
See Page: 108

**MAX DISTANCE:** 15 MBPS 330 FT; 12 MBPS 100 FT.

**COMPATIBLE DEVICES:** USB-WP-H, USB-WP-C

## USB 2.0 HIGH SPEED TWISTED PAIR EXTENDER

### DIGI-USB2

USB



SOLD AS A SET



HOST DEVICE ENDS



CLIENT DEVICE ENDS



Scan QR code to save a text link to detailed specs, info, & available training videos

### Features & Benefits:

- Extends USB high speed (480 Mbps) up to 330 feet
- Can be powered at either the client or host device
- Can also be used to extend USB 1.1 signals

### Application:

- Great for extending high-bandwidth USB devices, such as HD webcams and motion-controlled gaming devices
- Uses any Cat5e/6/6A twisted pair cabling
- Plenum routing of USB 1.1 and 2.0 full or high speed
- Ideal for education, government, house of worship, corporate, residential, and any other application requiring extended USB signal distribution



### USB CABLES

See Page: 108

MAX DISTANCE:

COMPATIBLE DEVICES:

## PASSIVE VGA BALUN

### AVO-VGA

VGA



2 DEVICES SOLD AS A SET



TWISTED PAIR END



VGA END



Scan QR code to save a text link to detailed specs, info, & available training videos

### Features & Benefits:

- One VGA to one RJ45 connectivity
- Transmits/receives one VGA video signal
- Up to 450 feet cable lengths on S/UTP category 5/5e/6
- Bandwidth: DC to 60 MHz

### Application:

- Ideal for corporate facilities, churches, schools, auditoriums and almost any other situation involving VGA video signal distribution
- Long distance routing of VGA video up to 450 feet over structured cabling such as Cat5
- Used in pairs, these baluns replace bulky coax cable and utilize a building's existing structured cabling network



### VGA CABLES

Reliable options for any professional installer  
See Page 109

MAX DISTANCE: VGA (640 X 480): 450 FEET; SVGA (800 X 600): 350 FEET; XGA (1024 X 768): 250 FEET; SXGA (1280 X 1024): 200 FEET

COMPATIBLE DEVICES: AVO-VGA2-WP

## PASSIVE VGA BALUN - RECEIVER

### AVO-VGA-R

VGA



TWISTED PAIR END



VGA END



Scan QR code to save a text link to detailed specs, info, & available training videos

### Features & Benefits:

- One VGA to one RJ45 connectivity
- Receives one VGA video signal
- Up to 450 feet cable lengths on S/UTP category 5/5e/6
- This is one unit, transmitter needed to complete the circuit
- Bandwidth: DC to 60 MHz

### Application:

- Ideal for corporate facilities, churches, schools, auditoriums and almost any other situation involving VGA video signal distribution
- Long distance routing of VGA video up to 450 feet over structured cabling such as Cat5
- Used in pairs, these baluns replace bulky coax cable and utilize a building's existing structured cabling network

MAX DISTANCE: VGA (640X480 PIXELS): 450 FEET; SVGA (800X600 PIXELS): 350 FEET; XGA (1024X768 PIXELS): 250 FEET; SXGA (1280X1024 PIXELS): 200 FEET

COMPATIBLE DEVICES: AVO-VGA2-WP, AVO-VGA2-WP-S, AVO-VGA-WP



## PASSIVE VGA BALUN - TRANSMITTER

## AVO-VGA-S

VGA



TWISTED PAIR END



VGA END



**TOOLS & ACCESSORIES**  
Save time and money!  
See Page: 247

### Features & Benefits:

- One VGA to one RJ45 connectivity
- Transmits one VGA video signal
- Up to 450 feet cable lengths on S/UTP category 5/5e/6
- This is one unit, receiver needed to complete the circuit
- Bandwidth: DC to 60 MHz

### Application:

- Ideal for corporate facilities, churches, schools, auditoriums and almost any other situation involving VGA video signal distribution
- Long distance routing of VGA video up to 450 feet over structured cabling such as Cat5
- Used in pairs, these baluns replace bulky coax cable and utilize a building's existing structured cabling network

**MAX DISTANCE:** VGA (640X480 PIXELS): 450 FEET; SVGA (800X600 PIXELS): 350 FEET; XGA (1024X768 PIXELS): 250 FEET; SXGA (1280X1024 PIXELS): 200 FEET

**COMPATIBLE DEVICES:** AVO-VGA2-WP-R, AVO-VGA-R

## VGA OVER TWISTED-PAIR EXTENDER & DISTRIBUTION AMP

## DIGI-VGA-F

VGA



2 DEVICES, SOLD AS A SET



DIGI-VGA-R-F: BACK



DIGI-VGA-S-F: BACK



Scan QR code to save a text link to detailed specs, info, & available training videos

### Features & Benefits:

- RGBHV video up to 1920x1200 at 250 feet down to 800x600 at 850 feet (Cat 6)
- Local output on send balun for added versatility
- Receive balun features dual amplified audio/video outputs for signal distribution
- Brightness, contrast, and picture quality controls
- Sold as a send/receive pair

### Application:

- Extend 1920x1200 up to 250 feet, lower resolutions can be transmitted over longer distances
- Ideal for corporate facilities, churches, schools, and conference centers



**CATEGORY PATCH CABLES**  
Top quality reliable options for any type of installation  
See Page: 92

**MAX DISTANCE:** 1920 X 1200 RESOLUTION 250 FEET; 1600 X 1200 RESOLUTION 350 FEET; 1280 X 1024 RESOLUTION 500 FEET; 1024 X 768 RESOLUTION 700 FEET; 800 X 600 RESOLUTION 850 FEET

**COMPATIBLE DEVICES:** N/A

## VGA, IR & RS232 OVER TWISTED-PAIR RECEIVER

## DIGI-VGASD2-R

VGA



Scan QR code to save a text link to detailed specs, info, & available training videos

### Features & Benefits:

- Receives computer video, stereo audio, and control signals over a single twisted pair cable, such as Cat 5e or Cat 6
- Dual amplified outputs and adjustable video equalization
- Can pass resolutions up to 1920x1200 and 20 Hz to 20 kHz audio up to 350 feet
- Bi-directional IR and RS232 extension up to 350 feet
- Receiver only - compatible transmitter required

### Application:

- Receives computer video, stereo audio, and control signals over a single twisted pair cable, such as Cat 5e or Cat 6
- Dual amplified outputs and adjustable video equalization
- Can pass resolutions up to 1920x1200 and 20 Hz to 20 kHz audio up to 350 feet
- Bi-directional IR and RS232 extension up to 350 feet

**MAX DISTANCE:** 350 FEET

**COMPATIBLE DEVICES:** DIGI-VGASD2-S, DIGI-VGASD2-T4, DIGI-VGASD2-T8

## VGA, IR & RS232 OVER TWISTED-PAIR TRANSMITTER

### DIGI-VGASD2-S

VGA



Scan QR code to save a text link to detailed specs, info, & available training videos

#### Features & Benefits:

- Transmits computer video, stereo audio, and control signals over a single twisted pair cable, such as Cat 5e or Cat 6
- Local VGA and stereo audio outputs
- EDID copy feature stores destination device's EDID information
- Can pass resolutions up to 1920x1200 and 20 Hz to 20 kHz audio up to 350 feet
- Bi-directional IR and RS232 extension up to 350 feet
- Transmitter only - DIGI-VGASD2-R required

#### Application:

- Transmit computer video, audio, and control signals to a remote destination up to 350 feet away
- Ideal for corporate facilities, churches, schools, and conference centers
- Only for point to point configurations



**VGA CABLES**  
Reliable options for any professional installation  
See Page 109

MAX DISTANCE: 350 FEET

COMPATIBLE DEVICES: DIGI-VGASD2-R

## VGA, IR & RS232 OVER TWISTED-PAIR DISTRIBUTION AMP - 4 OUTPUT

### DIGI-VGASD2-T4

VGA



Scan QR code to save a text link to detailed specs, info, & available training videos

#### Features & Benefits:

- Transmits computer video, stereo audio, and control signals to four remote destinations over twisted pair cable, such as Cat 5e or Cat 6
- Local VGA and stereo audio outputs
- EDID copy feature stores destination device's EDID information
- Can pass resolutions up to 1920x1200 and 20 Hz to 20 kHz audio up to 350 feet
- IR and RS232 extension up to 350 feet, bi-directional on output 1 only
- Linkable up to 32 total outputs

#### Application:

- Transmit computer video, audio, and control signals to four remote destinations up to 350 feet away
- Ideal for digital signage, corporate facilities, churches, schools, and conference centers
- Designed for point-to-many configurations (4 destination devices)

MAX DISTANCE: 350 FEET

COMPATIBLE DEVICES: DIGI-VGASD2-R

## VGA, IR & RS232 OVER TWISTED-PAIR DISTRIBUTION AMP - 8 OUTPUT

### DIGI-VGASD2-T8

VGA



Scan QR code to save a text link to detailed specs, info, & available training videos

#### Features & Benefits:

- Transmits computer video, stereo audio, and control signals to eight remote destinations over twisted pair cable, such as Cat 5e or Cat 6
- Local VGA and stereo audio outputs
- EDID copy feature stores destination device's EDID information
- Can pass resolutions up to 1920x1200 and 20 Hz to 20 kHz audio up to 350 feet
- IR and RS232 extension up to 350 feet, bi-directional on output 1 only
- Linkable up to 64 total outputs

#### Application:

- Transmit computer video, audio, and control signals to eight remote destinations up to 350 feet away
- Ideal for digital signage, corporate facilities, churches, schools, and conference centers
- Designed for point-to-many configurations (8 destination devices)

**THE LIBERTY** **MONEY-SAVING SERVICES!**  
**EDGE** Go to [www.LibAV.com](http://www.LibAV.com) or contact your rep today to make Liberty an extension of your workforce!

MAX DISTANCE: 350 FEET

COMPATIBLE DEVICES: DIGI-VGASD2-R

## HIGH RESOLUTION VGA OVER TWISTED-PAIR EXTENDER

VGA

VGA2-HR



2 DEVICES SOLD AS A SET



### CUSTOMER SERVICE

We offer technical assistance on all of our products or applications! Call us at 800-530-899 or email: [orders@LibAV.com](mailto:orders@LibAV.com)



Scan QR code to save a text link to detailed specs, info, & available training videos

### Features & Benefits:

- Extends a computer video signal (maximum of 1600x1200) up to 350 feet
- Dipswitch controlled adjustable color skew equalization
- Built-in EDID presets for common resolutions (1024x768 and 1280x800 @ 50/60 Hz)
- EDID copy feature stores destination device's EDID information onto the VGA2-HR transmitter

### Application:

- Ideal for corporate facilities, churches, schools, auditoriums and almost any other situation involving VGA video signal distribution
- Long distance routing of VGA video up to 350 feet over structured cabling such as Cat5
- Used in pairs, these baluns replace bulky coax cable and utilize a building's existing structured cabling network

MAX DISTANCE: 350 FEET @ 1600X1200

COMPATIBLE DEVICES: N/A

## ULTRA HIGH RESOLUTION VGA OVER TWISTED-PAIR EXTENDER

VGA

VGA2-UHR



2 DEVICES SOLD AS A SET



RECEIVE UNIT ENDS



SEND UNIT ENDS



Scan QR code to save a text link to detailed specs, info, & available training videos

### Features & Benefits:

- Extends a computer video signal (maximum of 1920x1200) up to 550 feet
- Dipswitch controlled adjustable color skew equalization
- Built-in EDID presets for common resolutions (1024x768 and 1280x800 @ 50/60 Hz)
- EDID copy feature stores destination device's EDID information onto the VGA2-UHR transmitter

### Application:

- Ideal for corporate facilities, churches, schools, auditoriums and almost any other situation involving VGA video signal distribution
- Long distance routing of VGA video up to 550 feet over structured cabling such as Cat5
- Used in pairs, these baluns replace bulky coax cable and utilize a building's existing structured cabling network

MAX DISTANCE: 550 FEET @ 1920X1200

COMPATIBLE DEVICES: N/A

# HDMI ADAPTER RING

**DIGITALINX**  
DL-AR

SEE PAGE 132

Keep your adapters where they need to be & immediately accessible for your mobile content presentation podium, boardroom, or docking station!

### PERFECT FOR:

- Adapting various mobile content devices to HDMI
- Interfacing Laptops, Macs, iPad, Smartphone to HDMI



# HDMI EXTENDER REFERENCE GUIDE

	<p><b>DIGI-HDE</b> <i>HDMI, Bi-directional Wideband IR, RS232 and Ethernet</i></p> <ul style="list-style-type: none"> <li>• 330 feet @ 1080p (Cat 6)</li> <li>• Extension over a single twisted pair cable</li> <li>• HDBaseT</li> <li>• 3D</li> <li>• 4Kx2K and loss-less audio formats</li> <li>• Powered at transmit and receive</li> </ul> <p style="text-align: right;"><b>Best</b></p>
	<p><b>DIGI-HD70</b> <i>HDMI</i></p> <ul style="list-style-type: none"> <li>• 230 feet @ 1080p (Cat 6)</li> <li>• Extension over a single twisted pair cable</li> <li>• HDBaseT-Lite</li> <li>• 3D</li> <li>• 4kx2k and loss-less audio formats</li> <li>• Powered at transmit and receive</li> </ul> <p style="text-align: right;"><b>Best</b></p>
	<p><b>DIGI-HD-IR3</b> <i>HDMI and Bi-directional Wideband IR</i></p> <ul style="list-style-type: none"> <li>• 110 feet @ 1080p (Cat 6)</li> <li>• Extension over dual twisted pair cables</li> <li>• Traditional twisted pair extender (TMDS)</li> <li>• 3D</li> <li>• 220 ft @ 1080i/720p (Cat 6)</li> <li>• EDID management</li> <li>• Powered at transmit and receive</li> </ul> <p style="text-align: right;"><b>Better</b></p>
	<p><b>DIGI-HD-IR3-WP</b> <i>HDMI and Bi-directional Wideband IR</i></p> <ul style="list-style-type: none"> <li>• 110 feet @ 1080p (Cat 6)</li> <li>• Extension over dual twisted pair cables</li> <li>• Traditional twisted pair extender (TMDS)</li> <li>• 3D</li> <li>• 220 ft @ 1080i/720p (Cat 6)</li> <li>• EDID management</li> <li>• Powered at transmit and receive</li> </ul> <p style="text-align: right;"><b>Better</b></p>
	<p><b>DIGI-HD-UHR2</b> <i>HDMI</i></p> <ul style="list-style-type: none"> <li>• 110 feet @ 1080p (Cat 6)</li> <li>• Extension over a single twisted pair cable</li> <li>• Traditional twisted pair extender (TMDS)</li> <li>• 3D</li> <li>• 220 ft @ 1080i/720p (Cat 6)</li> <li>• EDID management</li> <li>• Powered at transmit and receive</li> </ul> <p style="text-align: right;"><b>Better</b></p>
	<p><b>DIGI-HD-UHR2-WP</b> <i>HDMI</i></p> <ul style="list-style-type: none"> <li>• 110 feet @ 1080p (Cat 6)</li> <li>• Extension over a single twisted pair cable</li> <li>• Traditional twisted pair extender (TMDS)</li> <li>• 3D</li> <li>• 220 ft @ 1080i/720p (Cat 6)</li> <li>• EDID management</li> <li>• Powered at transmit and receive</li> </ul> <p style="text-align: right;"><b>Better</b></p>
	<p><b>DL-HDCAT</b> <i>HDMI</i></p> <ul style="list-style-type: none"> <li>• 165 feet</li> <li>• 100 feet @ 1080p (Cat 6)</li> <li>• Extension over dual twisted pair cables</li> <li>• Traditional twisted pair extender (TMDS)</li> <li>• 3D</li> <li>• 220 ft @ 1080i/720p (Cat 6)</li> <li>• Powered at receive</li> </ul> <p style="text-align: right;"><b>Good</b></p>
	<p><b>DL-HDCAT-WP</b> <i>HDMI</i></p> <ul style="list-style-type: none"> <li>• 165 feet</li> <li>• 100 feet @ 1080p (Cat 6)</li> <li>• Extension over dual twisted pair cables</li> <li>• Traditional twisted pair extender (TMDS)</li> <li>• 3D</li> <li>• 220 ft @ 1080i/720p (Cat 6)</li> <li>• Powered at receive</li> </ul> <p style="text-align: right;"><b>Good</b></p>
	<p><b>DIGI-HDMI-HR</b> <i>HDMI</i></p> <ul style="list-style-type: none"> <li>• Not rated for 1080p</li> <li>• Extension over dual twisted pair cables</li> <li>• Traditional twisted pair extender (TMDS)</li> <li>• 150 ft @ 1080i/720p (Cat 6)</li> <li>• Powered at send or receive</li> </ul> <p style="text-align: right;"><b>Good</b></p>

## HDBaseT - Corporate Boardroom

Intelix products are ideal for corporate applications, including boardrooms, meeting rooms, training rooms, conference rooms, and lobbies. The below drawing shows a boardroom with four PCs connected to an Intelix VGA2-SW4 switcher, the output of which is

converted to HDMI via an Intelix VGA-HD and then distributed to a remote FLX-8X8A switcher. The FLX-8X8A manages all of the audio-visual inputs and outputs, including the video from a camera and the remote LCDs and projectors.

### SUPPORT CABLES:

-  CATEGORY CABLE
-  HDMI CABLE
-  VGA CABLE

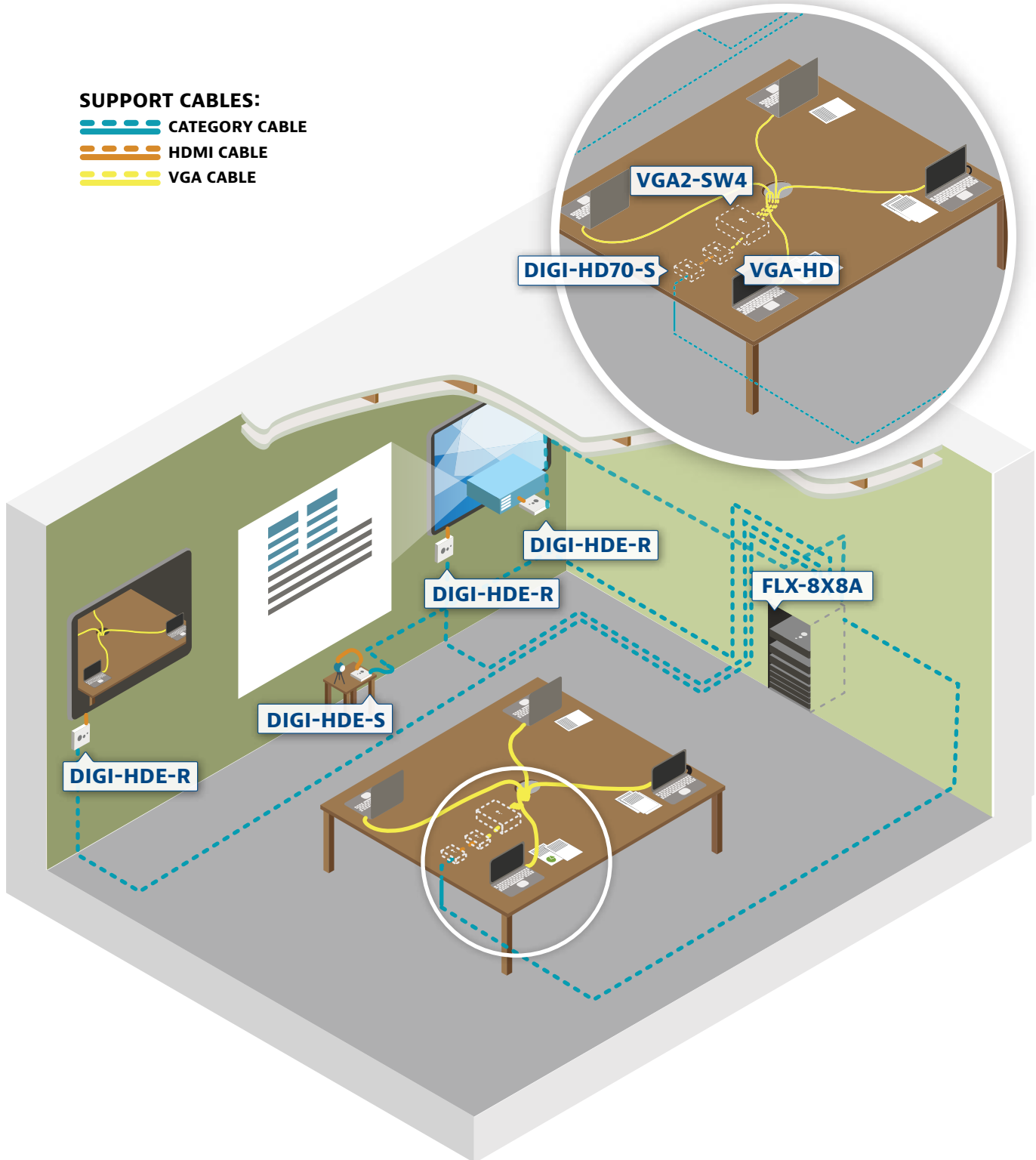

# FLEX MATRIX

*Ideal for any facilities requiring high definition multimedia distribution.*



Front



Back view without I/O cards



Back view with I/O cards inserted



HDBASET INPUT CARD, SEE ADDITIONAL PAGES FOR ALL AVAILABLE CARDS



WATCH IT NOW!  
FLX-8X8A

## CARD-BASED HDMI, DVI & ANALOG AUDIO/VIDEO MATRIX

### FLX-8X8A

#### Features and Benefits

- Plug and play card-based design allows user to select between analog, HDBaseT, HDMI and DVI-D inputs and outputs
- Converts and scales composite video, S-Video, component video and VGA inputs to HDMI or DVI
- Any input type to any output type
- 200ms average switching time
- Front panel RS232, IR and TCP/IP control
- HDMI and HDCP compliant
- Analog audio-follow-video or audio breakaway

#### Application:

- HDBaseT, HDMI, DVI-D and VGA signal switching and routing
- Receive 1080p and control signals from up to 229 feet away with FLX-BI4 and DIGI-HDE-S
- Extend 1080p and control signals up to 229 feet away with FLX-BO4 and DIGI-HDE-R
- Ideal for digital signage, corporate facilities, churches, schools, conference centers and any other facility that requires high definition multimedia distribution



**FLX-8X8A**  
Scan to go directly to web page

#### Tech Specs

<b>PART NUMBERS</b>	<b>ANALOG AUDIO INPUT/OUTPUT CONNECTIONS</b>	<b>FREQUENCY RESPONSE</b>	<b>INTERNAL POWER SUPPLY RATING</b>
FLX-8X8A	(8) 3.5 mm captive screw connectors, 5 pole	20 Hz to 20 kHz, ±0.5 dB	110-240 VAC, 50/60 Hz
<b>SUPPORTED MODULAR INPUT CARDS</b>	<b>CONTROL CONNECTION, REAR PANEL</b>	<b>COMMON MODE REJECTION RATIO</b>	<b>POWER CONSUMPTION</b>
FLX-BI4, FLX-DI4, FLX-HI4, FLX-RI4	RS232 via DB9, TCP/IP via RJ45	>90dB at 20 Hz to 20 kHz	50 watts
<b>SUPPORTED ANALOG AUDIO INPUT</b>	<b>CONTROL CONNECTION, FRONT PANEL</b>	<b>CROSSTALK</b>	<b>OPERATING TEMPERATURE</b>
Balanced or unbalanced stereo audio (20 Hz to 20 kHz)	Push button, IR	>80 dB at 1 kHz	0 to 40 C (+32 to 104 F)
<b>SUPPORTED MODULARE OUTPUT CARDS</b>	<b>AUDIO PINOUT</b>	<b>THD + NOISE</b>	<b>OPERATING HUMIDITY</b>
FLX-BO4, FLX-DO4, FLX-HO4	Left (+), left (-), ground, right (+), right (-)	1% at 1 kHz, 0.3% at 20 kHz	20% to 90%, non-condensing
<b>SUPPORTED ANALOG AUDIO OUTPUT</b>	<b>INPUT IMPEDANCE</b>	<b>ENCLOSURE</b>	<b>STORAGE TEMPERATURE</b>
Balanced or unbalanced stereo audio (20 Hz to 20 kHz)	>10KΩ	Black Metal	-10 to +60 C (+14 to +140 F)
<b>INPUT/OUTPUT CARD MOUNTING</b>	<b>OUTPUT IMPEDANCE</b>	<b>DIMENSIONS</b>	<b>STORAGE HUMIDITY</b>
Thumb screw	50Ω	3.47" (H) x 17.5" (W) x 12.6" (D), (2RU)	20% to 90%, non-condensing
		<b>SHIPPING WEIGHT</b>	
		12.5 lbs.	

## EXTREMELY VERSATILE

**The Intelix FLX-8X8A** is an extremely versatile solution for managing audio, video and control signals.

The system receives and transmits traditional HDMI signals, as well as bidirectional, IR and RS232 signals over twisted pair. A separate built-in balanced audio switcher provides audio reinforcement.

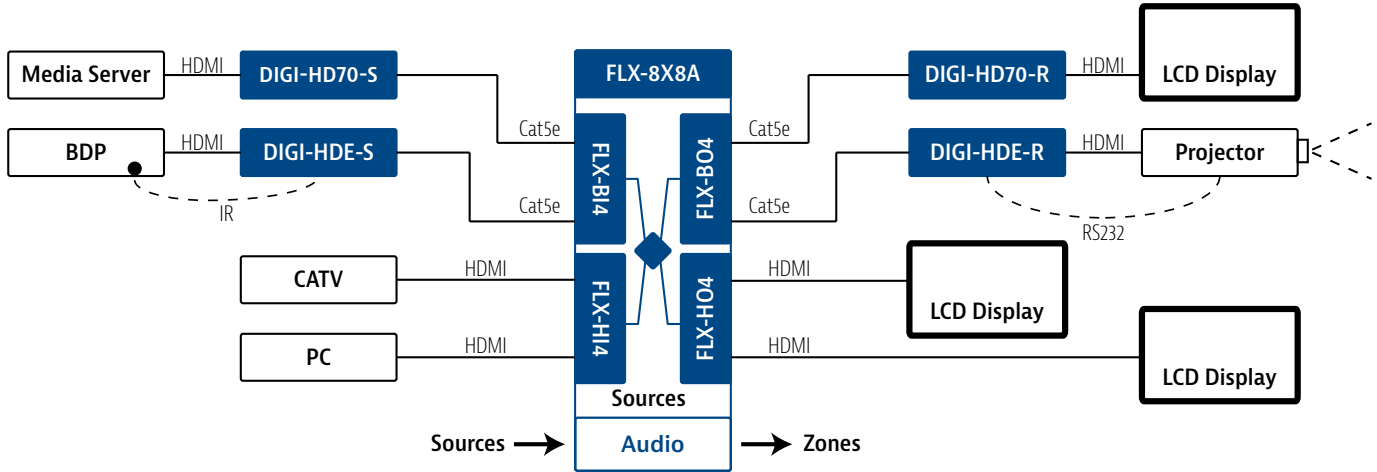

## INCORPORATES INPUT SCALING

**The Intelix FLX-8X8A** can incorporate input scaling through the use of RI4 card scaling & format conversion, providing the integration of composite, component, VGA, & S-video sources into the digital environment.

Plus, DVI input and output cards integrate into a myriad of sources, destination, and applications.

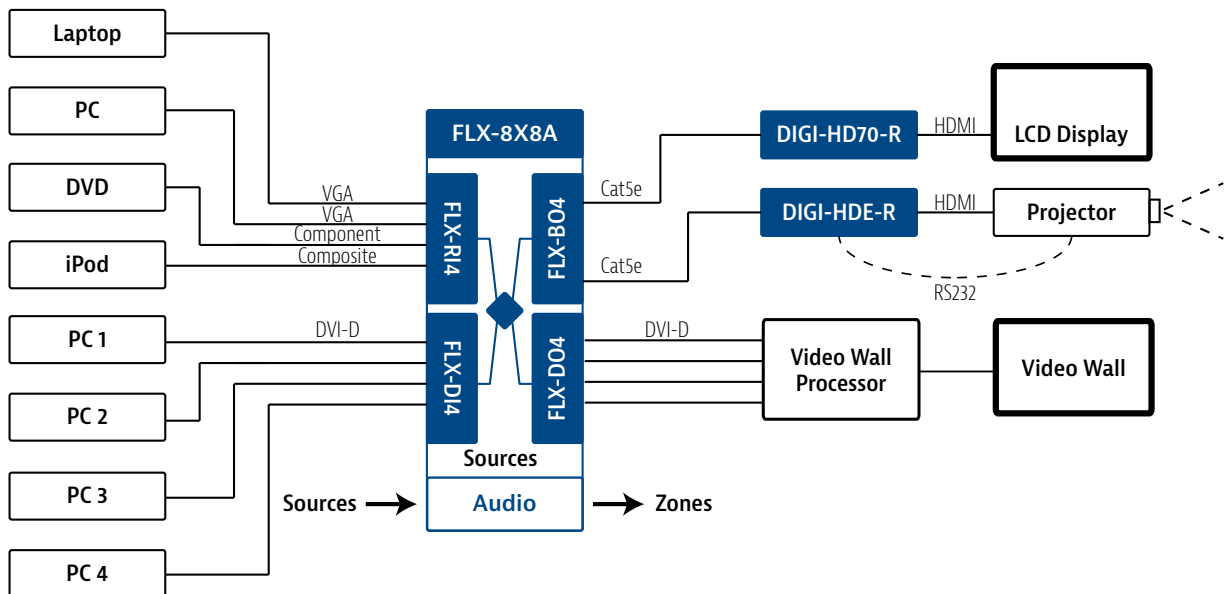

## FLEXIBLE CARD-BASED MATRIX SWITCHER - 8 INPUT X 8 OUTPUT

Matrix Switcher

FLX-8X8A



Scan QR code to save a text link to detailed specs, info, & available training videos

### Features & Benefits:

- Plug and play card-based design allows user to select between HDBaseT, HDMI, and DVI-D inputs and outputs
- Analog video scaling card available
- Any input type to any output type (VGA - input only)
- 200ms switching time - switching times will vary according to destination devices
- RS232, IR, and TCP/IP control
- HDMI and HDCP compliant
- Analog audio-follow-video or audio breakaway

### Application:

- HDBaseT, HDMI, DVI-D, and analog video signal switching and routing
- Extend 1080p up to 229 feet with FLX-BI4 and DIGI-HD70-R
- Ideal for digital signage, corporate facilities, churches, schools, conference centers, and any other facility that requires high definition multimedia distribution

MAX DISTANCE: 229 FEET (1080P)

COMPATIBLE DEVICES: FLX-HI4, FLX-DI4, FLX-BI4, FLX-RI4, FLX-HO4, FLX-DO4, FLX-BO4

## INPUT CARD FOR CARD-BASED MATRIX SWITCHER - HDMI

Matrix Switcher

FLX-HI4



**HDMI MOBILE ADAPTER RING GENIUS!**

See Page: 132

### Features & Benefits:

- HDMI input card for FLX-8X8A
- Four HDMI inputs
- HDMI and HDCP compliant

### Application:

- Designed for use with FLX-8X8A
- Ideal for corporate facilities, churches, schools, conference centers, and any other application requiring HDMI connectivity

MAX DISTANCE: N/A

COMPATIBLE DEVICES: FLX-8X8A

## OUTPUT CARD FOR CARD-BASED MATRIX SWITCHER - HDMI

Matrix Switcher

FLX-HO4



**HDMI CABLES**

Options for any type of professional installation  
See Page: 102

### Features & Benefits:

- HDMI output card for FLX-8X8A
- Four HDMI outputs
- HDMI and HDCP compliant

### Application:

- Designed for use with FLX-8X8A
- Ideal for any application requiring HDMI connectivity

MAX DISTANCE: N/A

COMPATIBLE DEVICES: FLX-8X8A

## INPUT CARD FOR CARD-BASED MATRIX SWITCHER - VGA

Matrix Switcher

FLX-RI4



**VGA CABLES**

Reliable options for any professional installation  
See Page 109

### Features & Benefits:

- VGA input card for FLX-8X8A
- Four VGA inputs
- Supported signal types: VGA-UXGA, RGBHV, RGSB, RsGsBs, Component Video, S-Video & Composite Video

### Application:

- Designed for use with FLX-8X8A
- Analog video scaling card
- Ideal for applications with legacy devices

MAX DISTANCE: N/A

COMPATIBLE DEVICES: FLX-8X8A



## OUTPUT CARD FOR CARD-BASED MATRIX SWITCHER - DVI-D

Matrix Switcher

FLX-DO4



**DVI CABLES**  
Reliable options for any professional installation  
See Page 93

### Features & Benefits:

- Single link DVI-D output card for FLX-8X8A
- Four DVI-D outputs
- HDMI and HDCP compliant

### Application:

- Designed for use with FLX-8X8A
- Ideal for the medical industry and other applications requiring high-definition locking connectors

MAX DISTANCE: N/A

COMPATIBLE DEVICES: FLX-8X8A

## INPUT CARD FOR CARD-BASED MATRIX SWITCHER - HDBaseT

Matrix Switcher

FLX-BI4



**CATEGORY PATCH CABLES**  
Top quality reliable options for any type of installation  
See Page: 92

### Features & Benefits:

- HDBaseT input card for FLX-8X8A
- Four HDBaseT RJ45 inputs
- RS232 and bidirectional IR transport
- Can be used with DIGI-HD70-S or DIGI-HDE-S to receive signal from remote sources
- HDMI and HDCP compliant

### Application:

- Designed for use with FLX-8X8A
- Ideal for installations requiring long HDMI runs and remote control of source and destination devices
- Receive signal from remote sources: 1080p up to 229 feet

MAX DISTANCE: 229 FEET (1080P)

COMPATIBLE DEVICES: FLX-8X8A, DIGI-HD70-S

## OUTPUT CARD FOR CARD-BASED MATRIX SWITCHER - HDBaseT

Matrix Switcher

FLX-BO4



Scan QR code to save a text link to detailed specs, info, & available training videos

### Features & Benefits:

- HDBaseT output card for FLX-8X8A
- Four HDBaseT RJ45 outputs
- RS232 and bidirectional IR transport
- Can be used with DIGI-HD70-R and DIGI-HDE-R to transmit signal from FLX-8X8A inputs to remote destination devices
- HDMI and HDCP compliant

### Application:

- Designed for use with FLX-8X8A
- Ideal for installations requiring long HDMI runs and remote control of displays
- Extends signals to remote destinations: 1080p up to 229 feet

MAX DISTANCE: 229 FEET (1080P)

COMPATIBLE DEVICES: FLX-8X8A, DIGI-HD70-R

## INPUT CARD FOR CARD-BASED MATRIX SWITCHER - DVI-D

Matrix Switcher

FLX-DI4



**DVI CABLES**  
Reliable options for any professional installation  
See Page 93

### Features & Benefits:

- Single link DVI-D input card for FLX-8X8A
- Four DVI-D inputs
- HDMI and HDCP compliant

### Application:

- Designed for use with FLX-8X8A
- Ideal for the medical industry and other applications requiring high-definition locking connectors

MAX DISTANCE: N/A

COMPATIBLE DEVICES: FLX-8X8A

## HDMI MATRIX SWITCHER - 4 INPUT X 4 OUTPUT

HDMI and Twisted Pair

DIGI-HD-4X4



Scan QR code to save a text link to detailed specs, info, & available training videos

### Features & Benefits:

- 4 HDMI input by 4 HDMI output + 4 S/UTP outputs
- HDMI & HDCP compliant
- Supports 1080p, 1080i, all HDMI Audio
- 3D compatible
- Supports infrared (IR) signal distribution
- Control via front panel, IP, RS-232, or IR protocols
- Includes wireless remote control

### Application:

- HDMI multimedia switching and distribution
- 1080p up to 150' over Cat6 cable with applicable receive units
- Digital signage, restaurant and bar, residential HDMI



**BARGAIN BIN!**  
**PRICES DROP DAILY**  
Check back daily for lower prices on overstock items!  
[www.LibAV.com](http://www.LibAV.com)

**MAX DISTANCE:** UP TO 300 FEET OVER A SINGLE TWISTED PAIR CABLE

**COMPATIBLE DEVICES:** DIGI-HD-UHR2-R, DIGI-HD-UHR2-WP-R, DIGI-HD-IR3-R, DIGI-HD-IR3-WP-R, DIGI-HD-XR

## Tech Specs

### PART NUMBERS

DIGI-HD-4X4

### HDMI INPUTS

One (1) HDMI Type A Receptacle Connector per input

### HDMI OUTPUTS

One (1) HDMI Type A Receptacle Connector per output

### TWISTED PAIR OUTPUTS

Two (2) 8P8C ports (Shielded RJ45) per output

### IR INPUT

One (1) 3.5 mm jack (TRS)

### IR OUTPUT

One (1) 3.5 mm jack (TS) per output

### 12V DC POWER

One (1) 5.5 mm Outside Diameter, 2.1 mm Inside Diameter Barrel

### CONTROL, REAR PANEL

RS232 via DE-9, TCP/IP via RJ45

### CONTROL, FRONT PANEL

Push Button, IR

### DIP SWITCH

Three switch DIP

### HDTV VIDEO RESOLUTIONS

480i, 480p, 576i, 576p, 720p, 1080i, 1080p

### VESA VIDEO RESOLUTIONS

Up to 1920x1200

### EMBEDDED AUDIO COMPATIBILITY

Up to PCM 5 channel, Dolby Digital TrueHD, and DTS-HD Master Audio

### MAXIMUM DISTANCE PER LINKED UNIT (CAT 5E)

1080p 3D: 66 feet, 1080p: 100 feet,  
1080i/720p: 200 feet,  
480i/480p/576i/576p: 200 feet

### MAXIMUM DISTANCE PER LINKED UNIT (SHIELDED CAT 6A)

1080p 3D: 100 feet, 1080p: 150 feet,  
1080i/720p: 300 feet,  
480i/480p/576i/576p: 300 feet

### DIP SWITCH MODES

1080i/2.0, 1080p/2.0, 1080p/5.1  
Copy and Use EDID, EDID from Display  
Single Twisted Pair Output or Dual Twisted Pair Output

### VIDEO AMPLIFIER BANDWIDTH

1.65 Gbps

### INPUT DDC SIGNAL

5.0 volts p-p (TTL)

### INPUT VIDEO SIGNAL

0.5 to 1.0 volts p-p

### SUPPORTED IR CARRIER FREQUENCY

36 - 40 kHz at 5 volts

### ENCLOSURE

Painted Steel

### DIMENSIONS

438mm x 213mm x 41mm  
(17.25" x 8.375" x 1.625")

### RACK SPACING

1 RU

### SHIPPING WEIGHT

3.22 kg (7.1 lbs)

### OPERATING TEMPERATURE

0° to +40°C (+32° to +104°F)

### OPERATING HUMIDITY

20% to 90%, Non-condensing

### STORAGE TEMPERATURE

-10° to +60°C (+14° to +140°F)

### STORAGE HUMIDITY

20% to 90%, Non-condensing

### POWER SUPPLY

12vDC / 3A

### POWER CONSUMPTION

10 watts

### ESD PROTECTION

15kV

### REGULATORY

CE, RoHS

### WARRANTY

2 years

### DIAGNOSTIC INDICATORS

Output status and power LEDs

### INCLUDED ACCESSORIES

US Power Supply, Installation Guide, IR Remote, IR Emitter (4 ea), IR Receiver, Mounting Brackets, Rubber Feet

### COMPATIBLE RECEIVERS

DIGI-HD-IR3-WP-R\*, DIGI-HD-IR3-R\*  
DIGI-HD-XR, DIGI-HD-IR2-R  
DIGI-HD-UHR2-WP-R, DIGI-HD-UHR2-R  
\*Bidirectional IR is not supported

## HDMI MATRIX SWITCHER - 4 INPUT X 8 OUTPUT

HDMI and Twisted Pair

DIGI-HD-4X8



Scan QR code to save a text link to detailed specs, info, & available training videos

### Features & Benefits:

- 4 HDMI input by 8 HDMI output + 8 S/UTP outputs
- HDMI & HDCP compliant
- Supports 1080p, 1080i, all HDMI Audio
- 3D compatible
- Supports infrared (IR) signal distribution
- Control via front panel, IP, RS-232, or IR protocols
- Includes wireless remote control

### Application:

- HDMI multimedia switching and distribution
- 1080p up to 150' over Cat6 cable with applicable receive units
- Digital signage, restaurant and bar, residential HDMI



**New Website**  
[www.LibAV.com](http://www.LibAV.com)  
**BETTER, STRONGER, EXPANSIVE!**

**MAX DISTANCE:** UP TO 300 FEET OVER A SINGLE TWISTED PAIR CABLE

**COMPATIBLE DEVICES:** DIGI-HD-UHR2-R, WP VERSION, DIGI-HD-IR3-R, WP VERSION, DIGI-HD-XR

## Tech Specs

### PART NUMBERS

DIGI-HD-4X8

### HDMI INPUTS

One (1) HDMI Type A Receptacle Connector per input

### HDMI OUTPUTS

One (1) HDMI Type A Receptacle Connector per output

### TWISTED PAIR OUTPUTS

Two (2) 8P8C ports (Shielded RJ45) per output

### IR INPUT

One (1) 3.5 mm jack (TRS)

### IR OUTPUT

One (1) 3.5 mm jack (TS) per output

### 12V DC POWER

One (1) 5.5 mm Outside Diameter, 2.1 mm Inside Diameter Barrel

### CONTROL, REAR PANEL

RS232 via DE-9, TCP/IP via RJ45

### CONTROL, FRONT PANEL

Push Button, IR

### DIP SWITCH

Three switch DIP

### HDTV VIDEO RESOLUTIONS

480i, 480p, 576i, 576p, 720p, 1080i, 1080p

### VESA VIDEO RESOLUTIONS

Up to 1920x1200

### EMBEDDED AUDIO COMPATIBILITY

Up to PCM 5 channel, Dolby Digital TrueHD, and DTS-HD Master Audio

### MAXIMUM DISTANCE PER LINKED UNIT (CAT 5E)

1080p 3D: 66 feet, 1080p: 100 feet, 1080i/720p: 200 feet, 480i/480p/576i/576p: 200 feet

### MAXIMUM DISTANCE PER LINKED UNIT (SHIELDED CAT 6A)

1080p 3D: 100 feet, 1080p: 150 feet, 1080i/720p: 300 feet, 480i/480p/576i/576p: 300 feet

### DIP SWITCH MODES

1080i/2.0, 1080p/2.0, 1080p/5.1 Copy and Use EDID, EDID from Display Single Twisted Pair Output or Dual Twisted Pair Output

### VIDEO AMPLIFIER BANDWIDTH

1.65 Gbps

### INPUT DDC SIGNAL

5.0 volts p-p (TTL)

### INPUT VIDEO SIGNAL

0.5 to 1.0 volts p-p

### SUPPORTED IR CARRIER FREQUENCY

36 - 40 kHz at 5 volts

### ENCLOSURE

Painted Steel

### DIMENSIONS

438mm x 213mm x 89mm (17.25" x 8.375" x 3.5")

### RACK SPACING

2 RU

### SHIPPING WEIGHT

3.22 kg (7.1 lbs)

### OPERATING TEMPERATURE

0° to +40°C (+32° to +104°F)

### OPERATING HUMIDITY

20% to 90%, Non-condensing

### STORAGE TEMPERATURE

-10° to +60°C (+14° to +140°F)

### STORAGE HUMIDITY

20% to 90%, Non-condensing

### POWER SUPPLY

12vDC / 3A

### POWER CONSUMPTION

10 watts

### ESD PROTECTION

15kV

### REGULATORY

CE, RoHS

### WARRANTY

2 years

### DIAGNOSTIC INDICATORS

Output status and power LEDs

### INCLUDED ACCESSORIES

US Power Supply, Installation Guide, IR Remote, IR Emitter (4 ea), IR Receiver, Mounting Brackets, Rubber Feet

### COMPATIBLE RECEIVERS

DIGI-HD-IR3-WP-R\*, DIGI-HD-IR3-R\*  
 DIGI-HD-XR, DIGI-HD-IR2-R  
 DIGI-HD-UHR2-WP-R, DIGI-HD-UHR2-R  
 \*Bidirectional IR is not supported

## HDMI MATRIX SWITCHER - 8 INPUT X 8 OUTPUT

HDMI and Twisted Pair

DIGI-HD-8X8



Scan QR code to save a text link to detailed specs, info, & available training videos

### Features & Benefits:

- 8 HDMI input by 8 HDMI output + 8 S/UTP outputs
- HDMI & HDCP compliant
- Supports 1080p, 1080i, all HDMI Audio
- 3D compatible
- Supports infrared (IR) signal distribution
- Control via front panel, IP, RS-232, or IR protocols
- 3.75" diagnostic touch screen input for setup and control
- Includes wireless remote control

### Application:

- HDMI multimedia switching and distribution
- 1080p up to 150' over Cat6 cable with applicable receive units
- Digital signage, restaurant and bar, residential HDMI



**HDMI MOBILE ADAPTER RING GENIOUS!**

See Page: 132

**MAX DISTANCE:** UP TO 300 FEET OVER A SINGLE TWISTED PAIR CABLE

**COMPATIBLE DEVICES:** DIGI-HD-UHR2-R, DIGI-HD-UHR2-WP-R, DIGI-HD-IR3-R, DIGI-HD-IR3-WP-R, DIGI-HD-XR

## Tech Specs

<b>PART NUMBERS</b>	<b>DIP SWITCH</b>	<b>INPUT DDC SIGNAL</b>	<b>STORAGE HUMIDITY</b>
DIGI-HD-8X8	Three switch DIP	5.0 volts p-p (TTL)	20% to 90%, Non-condensing
<b>HDMI INPUTS</b>	<b>HDTV VIDEO RESOLUTIONS</b>	<b>INPUT VIDEO SIGNAL</b>	<b>POWER SUPPLY</b>
One (1) HDMI Type A Receptacle Connector per input	480i, 480p, 576i, 576p, 720p, 1080i, 1080p	0.5 to 1.0 volts p-p	12vDC / 3A
<b>HDMI OUTPUTS</b>	<b>VESA VIDEO RESOLUTIONS</b>	<b>SUPPORTED IR CARRIER FREQUENCY</b>	<b>POWER CONSUMPTION</b>
One (1) HDMI Type A Receptacle Connector per output	Up to 1920x1200	36 - 40 kHz at 5 volts	10 watts
<b>TWISTED PAIR OUTPUTS</b>	<b>EMBEDDED AUDIO COMPATIBILITY</b>	<b>ENCLOSURE</b>	<b>ESD PROTECTION</b>
Two (2) 8P8C ports (Shielded RJ45) per output	Up to PCM 5 channel, Dolby Digital TrueHD, and DTS-HD Master Audio	Painted Steel	15kV
<b>IR INPUT</b>	<b>MAXIMUM DISTANCE PER LINKED UNIT (CAT 5E)</b>	<b>DIMENSIONS</b>	<b>REGULATORY</b>
One (1) 3.5 mm jack (TRS)	1080p 3D: 66 feet, 1080p: 100 feet, 1080i/720p: 200 feet, 480i/480p/576i/576p: 200 feet	438mm x 210mm x 178mm (17.25" x 8.25" x 7")	CE, RoHS
<b>IR OUTPUT</b>	<b>MAXIMUM DISTANCE PER LINKED UNIT (SHIELDED CAT 6A)</b>	<b>RACK SPACING</b>	<b>WARRANTY</b>
One (1) 3.5 mm jack (TS) per output	1080p 3D: 100 feet, 1080p: 150 feet, 1080i/720p: 300 feet, 480i/480p/576i/576p: 300 feet	4 RU	2 years
<b>12V DC POWER</b>	<b>DIP SWITCH MODES</b>	<b>SHIPPING WEIGHT</b>	<b>DIAGNOSTIC INDICATORS</b>
One (1) 5.5 mm Outside Diameter, 2.1 mm Inside Diameter Barrel	1080i/2.0, 1080p/2.0, 1080p/5.1 Copy and Use EDID, EDID from Display Single Twisted Pair Output or Dual Twisted Pair Output	5.44 kg (12 lbs)	Output status and power LEDs
<b>CONTROL, REAR PANEL</b>	<b>VIDEO AMPLIFIER BANDWIDTH</b>	<b>OPERATING TEMPERATURE</b>	<b>INCLUDED ACCESSORIES</b>
RS232 via DE-9, TCP/IP via RJ45	1.65 Gbps	0° to +40°C (+32° to +104°F)	US Power Supply, Installation Guide, IR Remote, IR Emitter (4 ea), IR Receiver, Mounting Brackets, Rubber Feet
<b>CONTROL, FRONT PANEL</b>		<b>OPERATING HUMIDITY</b>	<b>COMPATIBLE RECEIVERS</b>
Touch Panel, IR		20% to 90%, Non-condensing	DIGI-HD-IR3-WP-R*, DIGI-HD-IR3-R* DIGI-HD-XR, DIGI-HD-IR2-R DIGI-HD-UHR2-WP-R, DIGI-HD-UHR2-R *Bidirectional IR is not supported
		<b>STORAGE TEMPERATURE</b>	
		-10° to +60°C (+14° to +140°F)	

## SWITCHER, SCALER & ANALOG-TO-DIGITAL CONVERTER - 5 INPUT X 1 OUTPUT

### DIGI-SCAL-5

#### Multiformat



Scan QR code to save a text link to detailed specs, info, & available training videos

#### Features & Benefits:

- Reduces equipment clutter by combining a switcher, scaler, and format converter into one compact chassis
- Inputs: HDMI, VGA, YPbPr, YC, composite, & analog stereo audio for each analog input
- Outputs: HDMI and coaxial SPDIF
- Audio delay for lip sync corrections
- HDMI and HDCP compliant
- Control with IR remote, front panel and RS-232 protocols
- Supported output resolutions: 16x9 and 16x10 formats, including 720p, 1080p, 1280x1024, 1600x1200, and 1920x1200

#### Application:

- Easy integration of legacy components into a digital environment
- Analog to digital conversion and scaling to several resolutions, up to 1080p and WUXGA
- Ideal for corporate facilities, churches, schools, and conference centers



#### PREMADE AUDIO CABLES

Reliable and great quality!

See Page: 86

MAX DISTANCE: N/A

COMPATIBLE DEVICES: N/A

## VGA TO HDMI CONVERTER

### VGA-HD

#### Format Converter



HDMI END



VGA END



Scan QR code to save a text link to detailed specs, info, & available training videos

#### Features & Benefits:

- Converts VGA and stereo audio to HDMI
- Maintains native resolution to ensure pristine video
- Built-in EDID presets for common resolutions (1920x1080 and 1280x720, both with stereo audio)
- Dynamic EDID compatibility functionality ensures a PC will send a compatible resolution to the destination device
- Max resolution: 1920x1200

#### Application:

- Corporate facilities, churches, schools, auditoriums
- Any application where VGA video and stereo audio needs to be converted to HDMI



#### VGA CABLES

Reliable options for any professional installation

See Page 109



#### HDMI CABLES

Options for any type of professional installation

See Page: 102

MAX DISTANCE: 5 METERS WITH LIBERTY CABLES, LONGER DISTANCES WITH INTELIX EXTENDERS

COMPATIBLE DEVICES: VGA SOURCES, HDMI DISPLAY DEVICES

## SWITCHER, SCALER & ANALOG-TO-DIGITAL CONVERTER - 11 INPUT X 2 OUTPUT

### DIGI-SCAL-11X2

#### Switcher/Scaler



Scan QR code to save a text link to detailed specs, info, & available training videos

#### Features & Benefits:

- Frees up rack space by combining a switcher, scaler, and format converter into a single 1RU chassis
- Inputs: 4-HDMI, 2-CV, 2-YUV, 1-VGA, 1-YC, 1-DVI-I
- More Inputs: 5 stereo analog RCA, 1-EIAJ optical audio
- Outputs: 2-HDMI, 1 stereo analog RCA, 1-EIAJ optical
- Scales and converts inputs to 720p or 1080p
- HDMI and HDCP compliant
- Control with front panel, IR, RS-232 protocols
- Supported output resolutions: 720p and 1080p, max resolution:1080p

#### Application:

- Easy integration of legacy components into a digital environment
- Analog to digital conversion and scaling to 720p and 1080p
- Ideal for corporate facilities, churches, schools, and conference centers

MAX DISTANCE: 5 METERS WITH LIBERTY CABLES, LONGER DISTANCES WITH INTELIX EXTENDERS

COMPATIBLE DEVICES: SOURCES WITH THE FOLLOWING OUTPUTS: COMPOSITE VIDEO, S-VIDEO, COMPONENT VIDEO, VGA, DVI, HDMI, ANALOG STEREO AUDIO (RCA), OPTICAL DIGITAL AUDIO (TOSLINK)  
DISPLAY DEVICES WITH THE FOLLOWING INPUTS: HDMI, ANALOG STEREO AUDIO (RCA), OPTICAL DIGITAL AUDIO (TOSLINK)

## HDMI SWITCHER - 4 INPUT X 1 OUTPUT

HD-4X1

HDMI



Scan QR code to save a text link to detailed specs, info, & available training videos

### Features & Benefits:

- Supports 3D, 1080p, and PC resolutions up to 1920x1200
- Supports 7.1 channel audio including Dolby TrueHD and DTS-HD
- Audio Return Channel Support with de-embedding
- Control via front panel, IR and RS232
- Max resolution: 1080p

### Application:

- Switch between four HDMI sources
- Ideal for corporate facilities, churches, schools, conference centers and any other facility requiring HDMI source switching capabilities



**HDMI MOBILE ADAPTER RING GENIUS!**

See Page: 132

MAX DISTANCE: 5 METERS WITH LIBERTY CABLES, LONGER DISTANCES WITH INTELIX EXTENDERS

COMPATIBLE DEVICES: HDMI SOURCES, HDMI DISPLAY DEVICES

## SWITCHER, SCALER & ANALOG-TO-DIGITAL CONVERTER - 5 INPUT X 1 OUTPUT

DIGI-SCAL-5

Multiformat



Scan QR code to save a text link to detailed specs, info, & available training videos

### Features & Benefits:

- Reduces equipment clutter by combining a switcher, scaler, and format converter into one compact chassis
- Inputs: HDMI, VGA, YPbPr, YC, composite, & analog stereo audio for each analog input
- Outputs: HDMI and coaxial SPDIF
- Audio delay for lip sync corrections
- HDMI and HDCP compliant
- Control with front panel and RS-232 protocols
- Supported output resolutions: 16x9 and 16x10 formats, including 720p, 1080p, 1280x1024, 1600x1200, and 1920x1200. Max resolution: 1920x1200

### Application:

- Easy integration of legacy components into a digital environment
- Analog to digital conversion and scaling to several resolutions, up to 1080p and WUXGA
- Ideal for corporate facilities, churches, schools, and conference centers

MAX DISTANCE: 5 METERS WITH LIBERTY CABLES, LONGER DISTANCES WITH INTELIX EXTENDERS

COMPATIBLE DEVICES: SOURCES WITH THESE OUTPUTS: COMPOSITE VIDEO, S-VIDEO, COMPONENT VIDEO, VGA, HDMI, ANALOG STEREO AUDIO (RCA)  
DISPLAY DEVICES WITH THESE INPUTS: HDMI, ANALOG STEREO AUDIO (RCA), OPTICAL DIGITAL AUDIO (TOSLINK)

## SWITCHER, SCALER & ANALOG-TO-DIGITAL CONVERTER - 11 INPUT X 2 OUTPUT

DIGI-SCAL-11X2

Switcher/Scaler



Scan QR code to save a text link to detailed specs, info, & available training videos

### Features & Benefits:

- Frees up rack space by combining a switcher, scaler, and format converter into a single 1RU chassis
- Inputs: 4-HDMI, 2-CV, 2-YUV, 1-VGA, 1-YC, 1-DVI-I
- More Inputs: 5 stereo analog RCA, 1-EIAJ optical audio
- Outputs: 2-HDMI, 1 stereo analog RCA, 1-EIAJ optical
- Scales and converts inputs to 720p or 1080p
- HDMI and HDCP compliant
- Control with front panel, IR, IP, RS-232 protocols
- Supported output resolutions: 720p and 1080p, max resolution: 1080p

### Application:

- Easy integration of legacy components into a digital environment
- Analog to digital conversion and scaling to 720p and 1080p
- Ideal for corporate facilities, churches, schools, and conference centers

**THE LIBERTY MONEY-SAVING SERVICES!**  
Go to [www.LibAV.com](http://www.LibAV.com) or contact your rep today to make Liberty an extension of your workforce!

MAX DISTANCE: 5 METERS WITH LIBERTY CABLES, LONGER DISTANCES WITH INTELIX EXTENDERS

COMPATIBLE DEVICES: SOURCES WITH THE FOLLOWING OUTPUTS: COMPOSITE VIDEO, S-VIDEO, COMPONENT VIDEO, VGA, DVI, HDMI, ANALOG STEREO AUDIO (RCA), OPTICAL DIGITAL AUDIO (TOSLINK)  
DISPLAY DEVICES WITH THE FOLLOWING INPUTS: HDMI, ANALOG STEREO AUDIO (RCA), OPTICAL DIGITAL AUDIO (TOSLINK)

**RGB & COMPONENT VIDEO SWITCHER - 4 INPUT X 1 OUTPUT**

VGA

VGA2-SW4



Scan QR code to save a text link to detailed specs, info, & available training videos

**Features & Benefits:**

- Allows up to 4 total RGB (or component video), and stereo audio signals to be switched on one destination device
- Control via front panel, IR and RS232
- Supports several resolutions up to 1080p and WUXGA
- Max resolution: 1920x1200

**Application:**

- Switch between four RGB or component video sources
- Ideal for corporate facilities, churches, schools, conference centers and any other facility requiring RGB and component video source switching capabilities



**COMPREHENSIVE VIDEO TRAINING**  
[www.LibAV.com](http://www.LibAV.com)

**MAX DISTANCE:** 5 METERS WITH LIBERTY CABLES, LONGER DISTANCES WITH INTELIX EXTENDERS  
**COMPATIBLE DEVICES:** VGA SOURCES, VGA DISPLAY DEVICES

# BARGAIN BIN

BULK & PREMADE CABLE | CONNECTORS & ADAPTORS | DEVICES | FIBER OPTIC | PLATES & PANELS | RACKS & MOUNTS | PRO TOOLS & MORE!



**GET GREAT DEALS ON OVERSTOCKED PRO AV PRODUCTS**

**PRICES DROP DAILY!**  
**CHECK IT OUT TODAY**  
**When they're gone they're gone!**

[www.LibAV.com](http://www.LibAV.com)  
**RUN WITH US**

\*WHILE SUPPLIES LAST, BARGAIN PRICES ARE GOOD FOR ONLINE ORDERS ONLY. MANUALLY SUBMITTED ORDERS WILL BE CHARGED STANDARD PRICING.

## INFRARED (IR) EMITTER FOR INTELIX VGASD2 DEVICES

Multiformat **DIGI-VGASD2-EMT**



### Features & Benefits:

- Emits infrared signals transmitted from a remote location
- Compatible with DIGI-VGASD2 line of products

### Application:

- Ideal for controlling devices from a remote location



Scan QR code to save a text link to detailed specs, info, & available training videos

**CABLE LENGTH:** 1.5 M (4.92 FT)

**COMPATIBLE DEVICES:** DIGI-VGASD2-S, DIGI-VGASD2-R, DIGI-VGASD2-T4, DIGI-VGASD2-T8

## INFRARED (IR) RECEIVER FOR INTELIX VGASD2 DEVICE

Multiformat **DIGI-VGASD2-EYE**



### Features & Benefits:

- Receives infrared signals to be transmitted to a remote location
- Compatible with DIGI-VGASD2 line of products

### Application:

- Ideal for controlling devices from a remote location



Scan QR code to save a text link to detailed specs, info, & available training videos

**CABLE LENGTH:** 1.5 M (4.92 FT)

**COMPATIBLE DEVICES:** DIGI-VGASD2-S, DIGI-VGASD2-R, DIGI-VGASD2-T4, DIGI-VGASD2-T8

## UNIVERSAL INFRARED (IR) EMITTER FOR INTELIX DEVICE

Multiformat **DIGIB-EMT**



### Features & Benefits:

- Emits infrared signals transmitted from a remote location
- Compatible with devices using wide-band IR

### Application:

- Ideal for controlling devices from a remote location



Scan QR code to save a text link to detailed specs, info, & available training videos

**CABLE LENGTH:** 1.5 M (4.92 FT)

**COMPATIBLE DEVICES:** FLX-BI4, FLX-B04, DIGI-HDE-S, DIGI-HDE-R, DIGI-HD70C-S, DIGI-HD70C-R, DIGI-HD-IR3-S, DIGI-HD-IR3-R, DIGI-HD-IR3-WP-S, DIGI-HD-IR3-WP-R, DIGI-HD-8X8, DIGI-HD-4X8, DIGI-HD-4X4, DIGI-HD-4X2

## UNIVERSAL INFRARED (IR) RECEIVER FOR INTELIX DEVICE

Multiformat **DIGIB-EYE**



### Features & Benefits:

- Receives infrared signals to be transmitted to a remote location
- Compatible with devices using wide-band IR

### Application:

- Ideal for controlling devices from a remote location



Scan QR code to save a text link to detailed specs, info, & available training videos

**CABLE LENGTH:** 1.5 M (4.92 FT)

**COMPATIBLE DEVICES:** FLX-BI4, FLX-B04, DIGI-HDE-S, DIGI-HDE-R, DIGI-HD70C-S, DIGI-HD70C-R, DIGI-HD-IR3-S, DIGI-HD-IR3-R, DIGI-HD-IR3-WP-S, DIGI-HD-IR3-WP-R, DIGI-HD-8X8, DIGI-HD-4X8, DIGI-HD-4X4, DIGI-HD-4X2

# THE LIBERTY EDGE

## LEVERAGE OUR SERVICES AS AN EXTENSION OF YOUR WORKFORCE!

Consolidate purchases, save time, labor and improve your profitability by putting the expansive Liberty Edge services to work for you!





## MODULAR EXTENDER MOUNTING BRACKET

Multiformat

## AVO-CLIP-F



Works perfectly  
WITH DIN-RACK-KIT-F



### Features & Benefits:

- Supports one balun or other small device
- Mounts to any screw-mountable surface

### Application:

- The perfect solution to rack-mounting Avocat Series baluns and several other Intelix extenders
- Mounts perfectly in the DIN-RACK-KIT-F



**DIMENSIONS:** DIMENSIONS WITHOUT DEVICE: 80 MM X 30 MM X 76 MM (3.15 IN. X 1.18 IN. X 2.99 IN.) DIMENSIONS ASSEMBLED WITH DEVICE: 100 MM X 35 M X 99 MM (3.94 IN. X 1.38 IN. X 3.91 IN.)

**COMPATIBLE DEVICES:** AVO-A2-F, AVO-A4-F, AVO-SVA2-F, AVO-V1-PAIR-F, AVO-V1A2-F, AVO-V2A2-F, AVO-V3AD-F, AVO-V3HD-F, AVO-V3PT-F

## RACK MOUNT TRAY FOR AVO-CLIP-F

Multiformat

## DIN-RACK-KIT-F

Works perfectly  
with AVO-CLIP-F



### Features & Benefits:

- Emits infrared signals transmitted from a remote location
- Compatible with AVO line of products

### Application:

- Supports two rows of 13 AVO-CLIPS
- Holds up to 26 Baluns
- Ideal for rack mounting a large number of baluns/extenders



**DIMENSIONS:** 110.5MM X 75.6MM X 21MM (4-5/16" X 3-1/8" X 7/8")

**COMPATIBLE DEVICES:** AVO-CLIP-F / AVO-A2-F, AVO-A4-F, AVO-SVA2-F, AVO-V1-PAIR-F, AVO-V1A2-F, AVO-V2A2-F, AVO-V3AD-F, AVO-V3HD-F, AVO-V3PT-F

## UNIVERSAL MOUNTING KIT FOR INTELIX 110X75 CHASSIS DEVICES

Mounting Hardware

## DIGI-PMK1



EXAMPLE OF DEVICE IN BRACKET



QUICK DEVICE INSERTION AND RELEASE



Scan QR code to save a text link to detailed specs, info, & available training videos

### Features & Benefits:

- VESA75 mounting pattern
- Unbreakable molded plastic
- Snap-in securing and release
- 10 per box

### RACK MOUNT

### POLE MOUNT



### Application:

- For Intelix 110x75 chassis device mounting on poles, walls, racks, TVs & VESA75
- Fits Intelix DIGI and AVO devices: DIGI-HD70-S, DIGI-HD70-R, DIGI-HD60C-S, DIGI-HD60C-R, AVO-VGA-S, AVO-VGA-R, DIGI-HD-IR3-S, DIGI-HD-IR3-R

**DIMENSIONS:** 110.5MM X 75.6MM X 21MM (4-5/16" X 3-1/8" X 7/8")

**COMPATIBLE DEVICES:** FLX-B14, FLX-B04, DIGI-HDE-S, DIGI-HDE-R, DIGI-HD70C-S, DIGI-HD70C-R, DIGI-HD-IR3-S, DIGI-HD-IR3-R, DIGI-HD-IR3-WP-S, DIGI-HD-IR3-WP-R, DIGI-HD-8X8, DIGI-HD-4X8, DIGI-HD-4X4, DIGI-HD-4X2

## FIELD TERMINATION HD CONTINUITY TESTER

75-001-01

Signal Tester



Scan QR code to save a text link to detailed specs, info, & available training videos

### Features & Benefits:

- Visual continuity tester
- All blue lights means good cable
- Does not test HDMI performance
- Requires two AA batteries (not included)

### Application:

- Test DIY HD Termination after completion for success
- Test existing cables for continuity



### HD CABLE TERMINATION SYSTEM

Get everything you need!

See Page 30

## HDMI TEST GENERATOR

HD-TG

Signal Tester



Scan QR code to save a text link to detailed specs, info, & available training videos

### Features & Benefits:

- Over 10 test pattern variations for testing a destination device's ability to reproduce a digital video signal
- Selectable HDCP encryption and diagnostics
- Selectable video output resolutions (up to WUXGA60 and 1080p)
- Supports embedded audio - internally generated and external

### Application:

- Handy tool used to gauge the performance of TVs, video monitors, and video projectors
- Ideal for AV technicians, custom electronics installers, and any facility that uses HDMI video systems



### HDMI CABLES

Options for any type of professional installation

See Page: 102

DIMENSIONS: 30MM X 125MM X 125MM (1.2" X 4.9" X 4.9")

COMPATIBLE DEVICES: HDMI, DVI

# WebBlox<sup>®</sup> CUSTOM PLATE DESIGN

ADD YOUR OWN LOGO | FREE SERVICE | DESIGN ONLINE, 24/7



This free design and quoting tool gives you complete control over designing your own custom plate and panel layouts. All PanelCrafters<sup>®</sup> standard panel sizes are available.

**GO FROM CONCEPT TO COMPLETE PLATE DESIGN IN MINUTES!**

**PANEL CRAFTERS**  
CUSTOM PLATES & PANELS

Check it out at [www.LibAV.com](http://www.LibAV.com)



**FIBERTRON**  
CUSTOM FIBER OPTICS



**LIBERTY**  
AV SOLUTIONS  
Distributed Product ★★★

**FIBER OPTIC SOLUTIONS**

**RUN WITH US**

# FIBER OPTIC SOLUTIONS

Whether you are working in a residential or commercial environment. Liberty offers a wide variety of AV Fiber Solutions which are designed to keep you both competitive and profitable.

No matter how complex or simple your installation needs are, Liberty has the expertise to provide you with the right products and information for both your fiber optic cable, custom or molded fiber optic assembly and fiber optic connector needs.

You can trust Fibertron Custom Fiber Optics to meet your most challenging point-to-point cabling needs. In performance, configuration, labeling and packaging, we have prestigious industry certifications in virtually every major marketplace.



- **CUSTOM FIBER INSTALL CABLES**
- **CUSTOM FIBER PATCH CORDS**
- **DATA CENTER CONFIGURATIONS**
- **LEMO® BROADCAST CABLES**
- **PRO A/V CONFIGURATIONS**
- **STANDARD FIBER PATCH CORDS**
- **FIELD TERMINATION TOOLS**

## BREAKOUT STYLE INDOOR FIBER OPTIC CABLE 2 FIBER OM3 50/125 MULTIMODE

**Commercial**  
**NON-PLENUM**



**Features & Benefits:**

- 2 fiber OM3 50/125 laser optimized multimode
- Dual layer tight buffer 900 micron
- Central strength member
- Breakout construction
- Indoor only flame rated PVC jacket
- NEC OFNR, CEC FT4, RoHS compliant
- Fiber is cut to order, 3,000 foot spools standard

**2FRIMM10-BO**

**Application:**

- Vertical and horizontal LAN 10/100/1000/10GBaseT ethernet
- Device to device, device to enclosure routing
- Digital multimedia routing and networking



**FIBER OPTIC PATCH PANELS**  
See Liberty's Fiber Optic patch panels [Page 207](#)

NOM OD (INCHES): 0.320	AWG SIZE: 50/125	# OF PAIRS: 1	# OF CONDUCTORS 2	AVAILABLE JACKET COLORS: ● AQUA
---------------------------	---------------------	------------------	----------------------	------------------------------------

## BREAKOUT STYLE INDOOR FIBER OPTIC CABLE 4 FIBER OM3 50/125 M ULTIMODE

**Commercial**  
**NON-PLENUM**

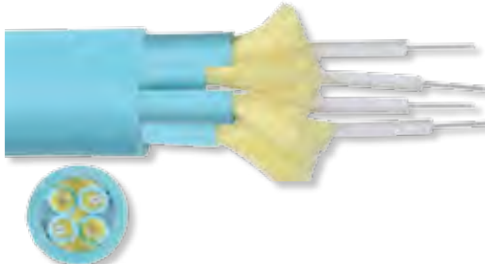

**Features & Benefits:**

- 4 fiber OM3 50/125 laser optimized multimode
- Dual layer tight buffer 900 micron
- Central strength member
- Breakout construction
- Indoor flame rated PVC jacket
- NEC OFNR, CEC FT4, RoHS compliant
- Fiber is cut to order, 3,000 foot spools standard

**4FRIMM10-BO**

**Application:**

- Vertical and horizontal LAN 10/100/1000/10GBaseT ethernet
- Device to device, device to enclosure routing
- Digital multimedia routing and networking

NOM OD (INCHES): 0.320	AWG SIZE: 50/125	# OF PAIRS: 2	# OF CONDUCTORS 4	AVAILABLE JACKET COLORS: ● AQUA
---------------------------	---------------------	------------------	----------------------	------------------------------------

## BREAKOUT STYLE INDOOR/OUTDOOR FIBER OPTIC CABLE 2 FIBER OM3 50/125 MULTIMODE

**Commercial**  
**NON-PLENUM**



**Features & Benefits:**

- 2 fiber OM3 50/125 laser optimized multimode
- Dual layer tight buffer 900 micron
- Central strength member
- Breakout construction
- UV stabilized PVC jacket
- NEC OFNR, CEC FT4, Sunlight resistant, RoHS compliant
- Fiber is cut to order, 3,000 foot spools standard

**2FRIMM10-BO**

**Application:**

- Vertical and horizontal LAN 10/100/1000/10GBaseT ethernet
- Device to device, device to enclosure routing
- Digital multimedia routing and networking

**THE LIBERTY EDGE** **MONEY-SAVING SERVICES!**  
Go to [www.LibAV.com](http://www.LibAV.com) or contact your rep today to make Liberty an extension of your workforce!

NOM OD (INCHES): 0.320	AWG SIZE: 50/125	# OF PAIRS: 1	# OF CONDUCTORS 2	AVAILABLE JACKET COLORS: ● AQUA
---------------------------	---------------------	------------------	----------------------	------------------------------------

## BREAKOUT STYLE INDOOR/OUTDOOR FIBER OPTIC CABLE 4 FIBER OM3 50/125 MULTIMODE

**Commercial**  
**NON-PLENUM**

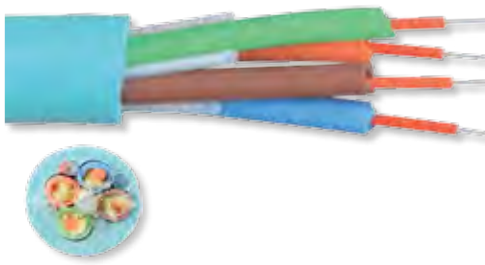

**Features & Benefits:**

- 4 fiber OM3 50/125 laser optimized multimode
- Dual layer tight buffer 900 micron
- Central strength member
- Breakout construction
- UV stabilized PVC jacket
- NEC OFNR, CEC FT4, sunlight resistant, RoHS compliant
- Fiber is cut to order, 3,000 foot spools standard

**4FRIMM10-BO**

**Application:**

- Vertical and horizontal LAN 10/100/1000/10GBaseT ethernet
- Device to device, device to enclosure routing
- Digital multimedia routing and networking

NOM OD (INCHES): 0.320	AWG SIZE: 50/125	# OF PAIRS: 2	# OF CONDUCTORS 4	AVAILABLE JACKET COLORS: ● AQUA
---------------------------	---------------------	------------------	----------------------	------------------------------------

## DISTRIBUTION STYLE INDOOR/OUTDOOR FIBER OPTIC CABLE 12 FIBER OM3 50/125 MULTIMODE

**Commercial**  
**NON-PLENUM**



**Features & Benefits:**

- 12 fiber OM1 62.5/125 multimode
- Dual layer tight buffer 900 micron
- Central strength member and kevlar yarn
- Distribution construction
- UV stabilized PVC jacket
- Sunlight resistant, suitable for wet locations
- NEC OFNR, CEC FT4, RoHS compliant
- Fiber is cut to order, 3,000 foot spools standard

**12FR10MM6-D**

**Application:**

- Vertical and horizontal LAN 10/100/1000BaseT ethernet
- Enclosure to enclosure network routing
- Conduit under grade, aerial sunlight exposure
- Digital multimedia routing and networking



**CATEGORY PATCH**  
Top quality reliable opt for any type of install  
See Page: 92

NOM OD (INCHES): 0.260	AWG SIZE: 62.5/125	# OF PAIRS: 6	# OF CONDUCTORS 12	AVAILABLE JACKET COLORS: ● BLACK
---------------------------	-----------------------	------------------	-----------------------	-------------------------------------

## DISTRIBUTION STYLE INDOOR/OUTDOOR FIBER OPTIC CABLE 12 FIBER OM3 50/125 MULTIMODE

**Commercial**  
**NON-PLENUM**



**Features & Benefits:**

- 12 fiber OM3 50/125 laser optimized multimode
- Dual layer tight buffer 900 micron
- Central strength member and kevlar yarn
- Distribution construction
- UV stabilized PVC jacket
- Sunlight resistant, suitable for wet locations
- NEC OFNR, CEC FT4, RoHS compliant
- Fiber is cut to order, 3,000 foot spools standard

**12FR10MM10-D**

**Application:**

- Vertical and horizontal LAN 10/100/1000/10G ethernet
- Enclosure to enclosure network routing
- Conduit under grade, aerial sunlight exposure
- Digital multimedia routing and networking

NOM OD (INCHES): 0.260	AWG SIZE: 50/125	# OF PAIRS: 6	# OF CONDUCTORS 12	AVAILABLE JACKET COLORS: ● AQUA
---------------------------	---------------------	------------------	-----------------------	------------------------------------

## DISTRIBUTION STYLE INDOOR/OUTDOOR FIBER OPTIC CABLE 12 FIBER OS1 9/125 SINGLE MODE

**Commercial**  
**NON-PLENUM**



**Features & Benefits:**

- 12 fiber OS1 singlemode
- Dual layer tight buffer 900 micron
- Central strength member and kevlar yarn
- Distribution construction
- UV stabilized PVC jacket
- Sunlight resistant, suitable for wet locations
- NEC OFNR, CEC FT4, RoHS compliant
- Fiber is cut to order, 3,000 foot spools standard

**12FR10SM-D**

**Application:**

- Vertical and horizontal LAN 10/100/1000BaseT ethernet
- HD Security Video, Telecommunications
- Enclosure to enclosure network routing
- Conduit under grade, aerial sunlight exposure
- Digital multimedia routing and networking

NOM OD (INCHES): 0.260	AWG SIZE: 9/125	# OF PAIRS: 6	# OF CONDUCTORS 12	AVAILABLE JACKET COLORS: ● BLACK ● YELLOW
---------------------------	--------------------	------------------	-----------------------	--

## DISTRIBUTION STYLE INDOOR/OUTDOOR FIBER OPTIC CABLE 2 FIBER OM1 62.5/125 MULTIMODE

**Commercial**  
**PLENUM**



**Features & Benefits:**

- 6 fiber OM1 62.5/125 multimode
- Dual layer tight buffer 900 micron
- Central strength member and kevlar yarn
- Distribution construction
- UV stabilized PVC jacket
- Sunlight resistant, suitable for wet locations
- NEC OFNR, CEC FT4, RoHS compliant
- Fiber is cut to order, 3,000 foot spools standard

**6FR10MM6-D**

**Application:**

- Vertical and horizontal LAN 10/100/1000BaseT ethernet
- Enclosure to enclosure network routing
- Conduit under grade, aerial sunlight exposure
- Digital multimedia routing and networking

NOM OD (INCHES): 0.220	AWG SIZE: 62.5/125	# OF PAIRS: 3	# OF CONDUCTORS 6	AVAILABLE JACKET COLORS: ● BLACK
---------------------------	-----------------------	------------------	----------------------	-------------------------------------

## DISTRIBUTION STYLE INDOOR/OUTDOOR FIBER OPTIC CABLE 4 FIBER OM3 50/125 MULTIMODE

**Commercial**  
**NON-PLENUM**

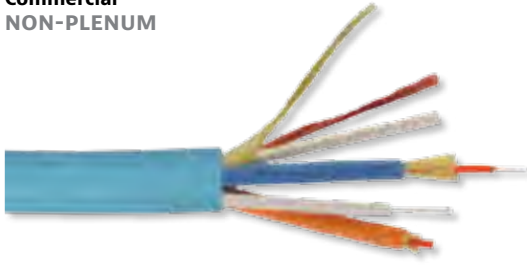

**Features & Benefits:**

- 4 fiber OM3 50/125 laser optimized multimode
- Dual layer tight buffer 900 micron
- Central strength member
- Breakout construction
- UV stabilized PVC jacket
- NEC OFNR, CEC FT4, sunlight resistant, RoHS compliant
- Fiber is cut to order, 3,000 foot spools standard

**4FR10MM10-D**

**Application:**

- Vertical and horizontal LAN 10/100/1000/10GBaseT ethernet
- Enclosure to enclosure network routing
- Conduit under grade, aerial sunlight exposure
- Digital multimedia routing and networking



NOM OD (INCHES): 0.200	AWG SIZE: 50/125	# OF PAIRS: 2	# OF CONDUCTORS 4	AVAILABLE JACKET COLORS: ● AQUA
---------------------------	---------------------	------------------	----------------------	------------------------------------

## DISTRIBUTION STYLE INDOOR/OUTDOOR FIBER OPTIC CABLE 6 FIBER OM1 62.5/125 MULTIMODE

**Commercial**  
**NON-PLENUM**



**Features & Benefits:**

- 2 fiber OM1 62.5/125 multimode
- Dual layer tight buffer 900 micron
- Central strength member and kevlar yarn
- Distribution construction
- UV stabilized PVC jacket
- Sunlight resistant, suitable for wet locations
- NEC OFNR, CEC FT4, RoHS compliant
- Fiber is cut to order, 3,000 foot spools standard

**2FR10MM6-D**

**Application:**

- Vertical and horizontal LAN 10/100/1000BaseT ethernet
- Enclosure to enclosure network routing
- Conduit under grade, aerial sunlight exposure
- Digital multimedia routing and networking

NOM OD (INCHES): 0.190	AWG SIZE: 62.5/125	# OF PAIRS: 1	# OF CONDUCTORS 2	AVAILABLE JACKET COLORS: ● BLACK
---------------------------	-----------------------	------------------	----------------------	-------------------------------------

## BREAKOUT STYLE INDOOR/OUTDOOR PLENUM FIBER OPTIC CABLE 4 FIBER OM3 50/125 MULTIMODE

**Commercial**  
**PLENUM**

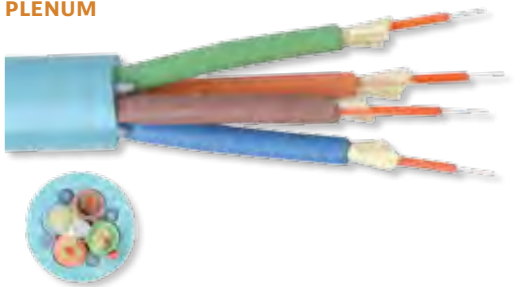

**Features & Benefits:**

- 4 fiber OM3 50/125 laser optimized multimode
- Dual layer tight buffer 900 micron
- Central strength member
- Breakout construction
- UV stabilized PVC jacket
- NEC OFNP, CEC FT6, Sunlight resistant, RoHS compliant
- Fiber is cut to order, 3,000 foot spools standard

**4FP10MM10-BO**

**Application:**

- Vertical and horizontal LAN 10/100/1000/10GBaseT ethernet
- Device to device, device to enclosure routing
- Digital multimedia routing and networking



NOM OD (INCHES): 0.260	AWG SIZE: 50/125	# OF PAIRS: 2	# OF CONDUCTORS 4	AVAILABLE JACKET COLORS: ● AQUA
---------------------------	---------------------	------------------	----------------------	------------------------------------

## BREAKOUT STYLE INDOOR/OUTDOOR PLENUM FIBER OPTIC CABLE 4 FIBER OM1 62.5/125 MULTIMODE

**Commercial**  
**PLENUM**

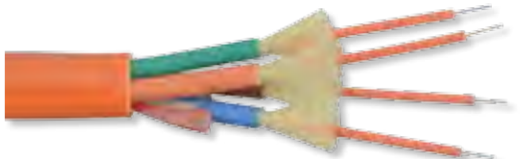

**Features & Benefits:**

- 4 fiber OM1 62.5/125 multimode
- Dual layer tight buffer 900 micron
- Central strength member
- Breakout construction
- UV stabilized PVC jacket
- NEC OFNP, CEC FT6, sunlight resistant, RoHS compliant
- Fiber is cut to order, 3,000 foot spools standard

**4FP10MM6-BO**

**Application:**

- Vertical and horizontal LAN 10/100/1000/10GBaseT ethernet
- Device to device, device to enclosure routing
- Digital multimedia routing and networking

NOM OD (INCHES): 0.260	AWG SIZE: 62.5/125	# OF PAIRS: 2	# OF CONDUCTORS 4	AVAILABLE JACKET COLORS: ● ORANGE
---------------------------	-----------------------	------------------	----------------------	--------------------------------------

# CORNING™ FIELD TERMINATION KIT FOR PERFECT FIBER TERMINATIONS

## Everything You Need!

The UniCam Pretium™ Tool Kit can be used with multimode or single-mode LC, SC and ST compatible UniCam Connectors.

- Perfect fiber terminations in one minute
- No Polishing
- No Headaches!

TKT-UNICAM-PFC



## SIX EASY STEPS!



Step 1 : Place the Connector in the Tool



Step 2 : Prepare the Fiber



Step 3 : Clean the Fiber



Step 4 : Cut Fiber to Proper Length



Step 5 : Crimp the Connectors onto the Fiber

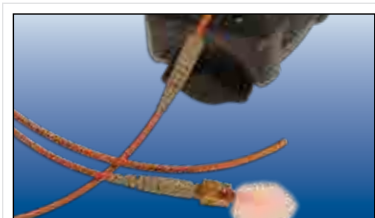

Step 6 : Test for Your Perfect Termination



## CORNING UNICAM FIBER OPTIC TERMINATION KIT



FIBER OPTIC TOOL KIT | **TKT-UNICAM-PFC**

### Features and Benefits:

- Termination tooling kit for SC, LC, and ST connectors
- Ergonomic suitcase design can go anywhere
- All supplies included, DVD and printed instructions
- Visual fault locator built into the termination tool
- Precision cleaver
- Indicator shows good termination before crimping

### Application:

- Applying Corning premium UNICAM fiber optic connectors
- Does not work with other brand connectors
- Terminates 95-\* series connectors in LC, ST, and SC
- Connectors for 62.5/125, 50/125, and singlemode fiber

## CORNING UNICAM TERMINATION SYSTEM FIBER CLEANING FLUID



FIBER OPTIC ACCESSORY | **FCC-CLEANER-FIBER**

### Features and Benefits:

- SC Plug Format
- 62.5/125 Multimode Fiber OM1
- Individual Bag with Multiple strain relief boots
- Fits both Breakout and Distribution style cable
- Specific for Corning Unicam PFC Systems

### Application:

- 10/100/1000BaseT Ethernet, High Bandwidth Media
- Audio, Video, Security, Gate Latching System install

## CORNING UNICAM TERMINATION SYSTEM FIBER CLEANING CLOTHS



FIBER OPTIC ACCESSORY | **FCC-WIPES**

### Features and Benefits:

- Single dispensing bottle of fiber cleaning cloths
- Replenishment for the TKT-UNICAM-PFC tool kit
- Can be used with any fiber or fiber tool kit

### Application:

- Fiber optic termination preparation
- Replenishment of UNICAM tool kit supplies

**THE LIBERTY EDGE** **MONEY-SAVING SERVICES!**  
Go to [www.LibAV.com](http://www.LibAV.com) or contact your rep today to make Liberty an extension of your workforce!

## CORNING UNICAM LC FIBER OPTIC CONNECTOR FOR OM1 62.5/125



LC | **95-000-99**

### Features and Benefits:

- LC Plug Format
- 62.5/125 Multimode Fiber
- Individual Bag with Multiple strain relief boots
- Fits both Breakout and Distribution style cable
- Specific for Corning Unicam PFC System

### Application:

- 10/100/1000BaseT Ethernet, High Bandwidth Media
- Audio, Video, Security, Gate Latching System install



**BARGAIN BIN  
PRICES DROP DAILY**  
[www.LibAV.com](http://www.LibAV.com)

## CORNING UNICAM SC FIBER OPTIC CONNECTOR FOR OM1 62.5/125



SC | **95-000-41**

### Features and Benefits:

- SC Plug Format
- 62.5/125 Multimode Fiber OM1
- Individual Bag with Multiple strain relief boots
- Fits both Breakout and Distribution style cable
- Specific for Corning Unicam PFC Systems

### Application:

- 10/100/1000BaseT Ethernet, High Bandwidth Media
- Audio, Video, Security, Gate Latching System install

## CORNING UNICAM SC FIBER OPTIC CONNECTOR FOR OM3/4 50/125



SC | **95-050-41-X**

### Features and Benefits:

- SC Plug Format
- 50/125 Laser Optimized Multimode OM3 / OM4
- Individual Bag with Multiple strain relief boots
- Fits both Breakout and Distribution style cable
- Specific for Corning Unicam PFC System

### Application:

- 10/100/1000/10GBaseT Ethernet, High bandwidth Media
- OEM Crestron, AMX, Savant HDMI Distribution
- Audio, Video, Security, Gate Latching System install

# FIBER OPTIC HDMI

Reliable, time-saving design with no tedious fiber terminations & requires no costly fiber tools

## ENGINEERED FOR INSTALLERS

The Celerity Detachable Fiber Optic connector supports a thin, durable fiber optic cable in multiple lengths to 1000'. The fiber optics are pre-terminated with a miniature plug (9mm width) which supports fiber optic transfer to and from HDMI.

The use of the miniature plug eliminates the need for time-consuming fiber terminations and the need for costly fiber optic tools. The miniature fiber optic plug securely connects to the Celerity Detachable HDMI connector at the source and display components.

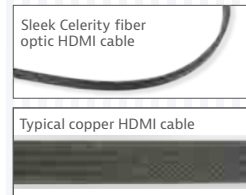

## DFO-1000P

### Features and Benefits

- Optimized for long distance transmission of HDMI® signals up to 1,000 feet
- Plenum-rated miniature fiber optic cable plug
- Fully supports HDMI video, audio and data
- Easy to prewire, no fiber terminations or costly fiber tools required
- Fast and reliable connection
- Detachable Fiber Optic HDMI connector
- First Audio Return Channel over fiber
- Superior bandwidth versus copper
- Eliminates need for send/receive baluns

### Application:

- Works with all HDMI certified components
- Blu-ray, DVD, AVR, switchers, game consoles, computer, high definition TV
- Home theater
- Whole-home video system
- Conference room system
- Multi-display system
- Digital signage
- Video display wall

Celerity Technologies' Fiber Optic Plug terminating each end of the Celerity Fiber Optic HDMI cable supports proprietary technology for HDMI over optical fiber. While the plug may appear similar to that of micro-HDMI or mini-USB, it does not support any technical attributes of either connector.

The Celerity fiber optic plug supports only proprietary Celerity technology and is connected to the Celerity Fiber Optic HDMI connector according to the user guide.



Sleek cable and supports up to 1,000' without loss of signal integrity and HDMI specification

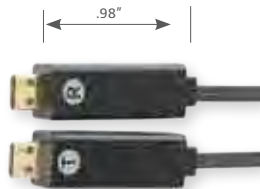

Miniature plug protects the fiber optics & internal electronics and allows for a simple and secure connection



Detachable HDMI connector makes pre-wiring of the fiber optic cable as easy as plug and play



Detachable Fiber Optic HDMI Connector

## FIBERTRON DUPLEX FIBER OPTIC PATCH CABLE OM1 STANDARD MULTIMODE LC-LC

**Commercial**  
**PLENUM**



**Features & Benefits:**

- OM1 62.5/125 multimode fiber
- Zipcord style plenum rated construction
- LC duplex to LC duplex connectivity
- 1, 2, 3 meters standard lengths, other lengths available on request
- Orange colored jacket laser optimized multimode
- NEC OFNP, CEC FT6, RoHS compliant

**DMM6LCLC**

**Application:**

- 10/100/1000 ethernet fiber patching
- A/V, data, control, phone support
- Economical solution to field termination
- Always patch out to equipment, it is the standard



**CUSTOMER SERVICE**

We offer technical assistance on all of our products or applications! Call us at 800-530-899 or email: [orders@LibAV.com](mailto:orders@LibAV.com)

AVAILABLE LENGTHS (METERS): 1, 2, 3  
PART NUMBER LENGTH ID: 001, 002, 003

AVAILABLE JACKET COLORS: ●  
ORANGE

## FIBERTRON DUPLEX FIBER OPTIC PATCH CABLE OM1 STANDARD MULTIMODE LC-SC

**Commercial**  
**PLENUM**



**Features & Benefits:**

- OM1 62.5/125 multimode fiber
- Zipcord style plenum rated construction
- LC duplex to SC duplex connectivity
- 1, 2, 3 meters standard lengths, other lengths available on request
- Orange colored jacket designates standard multimode
- NEC OFNP, CEC FT6, RoHS compliant

**DMM6LCSC**

**Application:**

- 10/100/1000 ethernet fiber patching
- A/V, data, control, phone support
- Economical solution to field termination
- Always patch out to equipment, it is the standard

AVAILABLE LENGTHS (METERS): 1, 2, 3  
PART NUMBER LENGTH ID: 001, 002, 003

AVAILABLE JACKET COLORS: ●  
ORANGE

## FIBERTRON DUPLEX FIBER OPTIC PATCH CABLE OM1 STANDARD MULTIMODE LC-ST

**Commercial**  
**PLENUM**



**Features & Benefits:**

- OM1 62.5/125 multimode fiber
- Zipcord style plenum rated construction
- LC duplex to 2 x ST connectivity
- 1, 2, 3 meters standard lengths, other lengths available on request
- Orange colored jacket designates standard multimode
- NEC OFNP, CEC FT6, RoHS compliant

**DMM6LCST**

**Application:**

- 10/100/1000 ethernet fiber patching
- A/V, data, control, phone support
- Economical solution to field termination
- Always patch out to equipment, it is the standard

AVAILABLE LENGTHS (METERS): 1, 2, 3  
PART NUMBER LENGTH ID: 001, 002, 003

AVAILABLE JACKET COLORS: ●  
ORANGE

## FIBERTRON DUPLEX FIBER OPTIC PATCH CABLE OM1 STANDARD MULTIMODE SC-SC

**Commercial**  
**PLENUM**



**Features & Benefits:**

- OM1 62.5/125 multimode fiber
- Zipcord style plenum rated construction
- SC duplex to SC duplex connectivity
- 1, 2, 3 meters standard lengths, other lengths available on request
- Orange colored jacket designates standard multimode
- NEC OFNP, CEC FT6, RoHS compliant

**DMM6SCSC**

**Application:**

- 10/100/1000 ethernet fiber patching
- A/V, data, control, phone support
- Economical solution to field termination
- Always patch out to equipment, it is the standard



**FIBER OPTIC PATCH PANELS**

See Liberty's Fiber Optic patch panels [Page 207](#)

AVAILABLE LENGTHS (METERS): 1, 2, 3  
PART NUMBER LENGTH ID: 001, 002, 003

AVAILABLE JACKET COLORS: ●  
ORANGE

## FIBERTRON DUPLEX FIBER OPTIC PATCH CABLE OM1 STANDARD MULTIMODE SC-ST

Commercial  
PLENUM



### Features & Benefits:

- OM1 62.5/125 multimode fiber
- Zipcord style plenum rated construction
- SC duplex to 2 x ST connectivity
- 1, 2, 3 meters standard lengths, other lengths available on request
- Orange colored jacket designates standard multimode
- NEC OFNP, CEC FT6, RoHS compliant

### DMM6SCST

#### Application:

- 10/100/1000 ethernet fiber patching
- A/V, data, control, phone support
- Economical solution to field termination
- Always patch out to equipment, it is the standard

AVAILABLE LENGTHS (METERS): 1, 2, 3  
PART NUMBER LENGTH ID: 001, 002, 003

AVAILABLE JACKET COLORS: ●  
ORANGE

## FIBERTRON DUPLEX FIBER OPTIC PATCH CABLE OM1 STANDARD MULTIMODE ST-ST

Commercial  
PLENUM



### Features & Benefits:

- OM1 62.5/125 multimode fiber
- Zipcord style plenum rated construction
- 2 x ST to 2 x ST connectivity
- 1, 2, 3 meters standard lengths, other lengths available on request
- Orange colored jacket designates standard multimode
- NEC OFNP, CEC FT6, RoHS compliant

### DMM6STST

#### Application:

- 10/100/1000 ethernet fiber patching
- A/V, data, control, phone support
- Economical solution to field termination
- Always patch out to equipment, it is the standard



**INSTALLER'S CHOICE**  
**SNAPRAX SERIES**  
See Page: 239

AVAILABLE LENGTHS (METERS): 1, 2, 3  
PART NUMBER LENGTH ID: 001, 002, 003

AVAILABLE JACKET COLORS: ●  
ORANGE

## FIBERTRON DUPLEX FIBER OPTIC PATCH CABLE OM2 STANDARD MULTIMODE LC-LC

Commercial  
PLENUM



### Features & Benefits:

- OM2 50/125 multimode fiber
- Zipcord style plenum rated construction
- LC duplex to LC duplex connectivity
- 1, 2, 3 meters standard lengths, other lengths available on request
- Orange colored jacket designates standard multimode
- NEC OFNP, CEC FT6, RoHS compliant

### DMM5LCLC

#### Application:

- 10/100/1000 ethernet fiber patching
- A/V, data, control, phone support
- Economical solution to field termination
- Always patch out to equipment, it is the standard

AVAILABLE LENGTHS (METERS): 1, 2, 3  
PART NUMBER LENGTH ID: 001, 002, 003

AVAILABLE JACKET COLORS: ●  
ORANGE

## FIBERTRON DUPLEX FIBER OPTIC PATCH CABLE OM2 STANDARD MULTIMODE LC-SC

Commercial  
PLENUM



### Features & Benefits:

- OM2 50/125 multimode fiber
- Zipcord style plenum rated construction
- LC duplex to SC duplex connectivity
- 1, 2, 3 meters standard lengths, other lengths available on request
- Orange colored jacket designates standard multimode
- NEC OFNP, CEC FT6, RoHS compliant

### DMM5LCS

#### Application:

- 10/100/1000 ethernet fiber patching
- A/V, data, control, phone support
- Economical solution to field termination
- Always patch out to equipment, it is the standard

AVAILABLE LENGTHS (METERS): 1, 2, 3  
PART NUMBER LENGTH ID: 001, 002, 003

AVAILABLE JACKET COLORS: ●  
ORANGE

## FIBERTRON DUPLEX FIBER OPTIC PATCH CABLE OM2 STANDARD MULTIMODE LC-ST

**Commercial**  
**PLENUM**



**Features & Benefits:**

- OM2 50/125 multimode fiber
- Zipcord style plenum rated construction
- LC duplex to 2 x ST connectivity
- 1, 2, 3 meters standard lengths, other lengths available on request
- Orange colored jacket designates standard multimode
- NEC OFNP, CEC FT6, RoHS compliant

**DMM5LCST**

**Application:**

- 10/100/1000 ethernet fiber patching
- A/V, data, control, phone support
- Economical solution to field termination
- Always patch out to equipment, it is the standard



**TECH SPECS**

Up-to-date and complete tech specs for all products available at [www.LibAV.com](http://www.LibAV.com)

AVAILABLE LENGTHS (METERS): 1, 2, 3  
PART NUMBER LENGTH ID: 001, 002, 003

AVAILABLE JACKET COLORS: ●  
ORANGE

## FIBERTRON DUPLEX FIBER OPTIC PATCH CABLE OM2 STANDARD MULTIMODE SC-SC

**Commercial**  
**PLENUM**



**Features & Benefits:**

- OM2 50/125 multimode fiber
- Zipcord style plenum rated construction
- SC duplex to SC duplex connectivity
- 1, 2, 3 meters standard lengths, other lengths available on request
- Orange colored jacket designates standard multimode
- NEC OFNP, CEC FT6, RoHS compliant

**DMM5SCSC**

**Application:**

- 10/100/1000 ethernet fiber patching
- A/V, data, control, phone support
- Economical solution to field termination
- Always patch out to equipment, it is the standard

AVAILABLE LENGTHS (METERS): 1, 2, 3  
PART NUMBER LENGTH ID: 001, 002, 003

AVAILABLE JACKET COLORS: ●  
ORANGE

## FIBERTRON DUPLEX FIBER OPTIC PATCH CABLE OM2 STANDARD MULTIMODE SC-ST

**Commercial**  
**PLENUM**



**Features & Benefits:**

- OM2 50/125 multimode fiber
- Zipcord style plenum rated construction
- SC duplex to 2 x ST connectivity
- 1, 2, 3 meters standard lengths, other lengths available on request
- Orange colored jacket designates standard multimode
- NEC OFNP, CEC FT6, RoHS compliant

**DMM5SCST**

**Application:**

- 10/100/1000 ethernet fiber patching
- A/V, data, control, phone support
- Economical solution to field termination
- Always patch out to equipment, it is the standard



**New Website**  
[www.LibAV.com](http://www.LibAV.com)  
**BETTER, STRONGER, EXPANSIVE!**

AVAILABLE LENGTHS (METERS): 1, 2, 3  
PART NUMBER LENGTH ID: 001, 002, 003

AVAILABLE JACKET COLORS: ●  
ORANGE

## FIBERTRON DUPLEX FIBER OPTIC PATCH CABLE OM2 STANDARD MULTIMODE ST-ST

**Commercial**  
**PLENUM**



**Features & Benefits:**

- OM2 50/125 multimode fiber
- Zipcord style plenum rated construction
- 2 x ST to 2 x ST connectivity
- 1, 2, 3 meters standard lengths, other lengths available on request
- Orange colored jacket designates standard multimode
- NEC OFNP, CEC FT6, RoHS compliant

**DMM5STST**

**Application:**

- 10/100/1000 ethernet fiber patching
- A/V, data, control, phone support
- Economical solution to field termination
- Always patch out to equipment, it is the standard

AVAILABLE LENGTHS (METERS): 1, 2, 3  
PART NUMBER LENGTH ID: 001, 002, 003

AVAILABLE JACKET COLORS: ●  
ORANGE

## FIBERTRON DUPLEX FIBER OPTIC PATCH CABLE OM3 LASER OPTIMIZED MULTIMODE LC-LC

**Commercial**  
**PLENUM**



**Features & Benefits:**

- OM3 50/125 laser optimized multimode fiber
- Zipcord style plenum rated construction
- LC duplex to LC duplex connectivity
- 1, 2, 3 meters standard lengths, other lengths available on request
- Aqua colored jacket designates Laser Optimized Multimode
- NEC OFNP, CEC FT6, RoHS compliant

**DMM10LCCLC**

**Application:**

- 10/100/1000/10G ethernet fiber patching
- Crestron, AMX, Savant system support
- Economical solution to field termination
- Always patch out to equipment, it is the standard

AVAILABLE LENGTHS (METERS): 1, 2, 3  
PART NUMBER LENGTH ID: 001, 002, 003

AVAILABLE JACKET COLORS: ● AQUA

## FIBERTRON DUPLEX FIBER OPTIC PATCH CABLE OM3 LASER OPTIMIZED MULTIMODE LC-SC

**Commercial**  
**PLENUM**



**Features & Benefits:**

- OM3 50/125 laser optimized multimode fiber
- Zipcord style plenum rated construction
- LC duplex to SC duplex connectivity
- 1, 2, 3 meters standard lengths, other lengths available on request
- Aqua colored jacket designates laser optimized multimode
- NEC OFNP, CEC FT6, RoHS compliant

**DMM10LCSC**

**Application:**

- 10/100/1000/10G ethernet fiber patching
- Crestron, AMX, Savant system support
- Economical solution to field termination
- Always patch out to equipment, it is the standard



**CUSTOM KITTING**  
Streamline your installs with a pre-packaged kit!

AVAILABLE LENGTHS (METERS): 1, 2, 3  
PART NUMBER LENGTH ID: 001, 002, 003

AVAILABLE JACKET COLORS: ● AQUA

## FIBERTRON DUPLEX FIBER OPTIC PATCH CABLE OM3 LASER OPTIMIZED MULTIMODE LC-ST

**Commercial**  
**PLENUM**



**Features & Benefits:**

- OM3 50/125 laser optimized multimode fiber
- Zipcord style plenum rated construction
- LC duplex to 2 x ST Connectivity
- 1, 2, 3 meters standard lengths, other lengths available on request
- Aqua colored jacket designates laser optimized multimode
- NEC OFNP, CEC FT6, RoHS compliant

**DMM10LCST**

**Application:**

- 10/100/1000/10G ethernet fiber patching
- Crestron, AMX, Savant system support
- Economical solution to field termination
- Always patch out to equipment, it is the standard

AVAILABLE LENGTHS (METERS): 1, 2, 3  
PART NUMBER LENGTH ID: 001, 002, 003

AVAILABLE JACKET COLORS: ● AQUA

## FIBERTRON DUPLEX FIBER OPTIC PATCH CABLE OM3 LASER OPTIMIZED MULTIMODE SC-SC

**Commercial**  
**PLENUM**



**Features & Benefits:**

- OM3 50/125 laser optimized multimode fiber
- Zipcord style plenum rated construction
- SC duplex to SC duplex connectivity
- 1, 2, 3 meters standard lengths, other lengths available on request
- Aqua colored jacket designates laser optimized multimode
- NEC OFNP, CEC FT6, RoHS compliant

**DMM10SCSC**

**Application:**

- 10/100/1000/10G ethernet fiber patching
- Crestron, AMX, Savant system support
- Economical solution to field termination
- Always patch out to equipment, it is the standard



**BARGAIN BIN**  
PRICES DROP DAILY  
[www.LibAV.com](http://www.LibAV.com)

AVAILABLE LENGTHS (METERS): 1, 2, 3  
PART NUMBER LENGTH ID: 001, 002, 003

AVAILABLE JACKET COLORS: ● AQUA

## FIBERTRON DUPLEX FIBER OPTIC PATCH CABLE OM3 LASER OPTIMIZED MULTIMODE SC-ST

**Commercial**  
**PLENUM**



**Features & Benefits:**

- OM3 50/125 laser optimized multimode fiber
- Zipcord style plenum rated construction
- SC duplex to 2 x ST connectivity
- 1, 2, 3 meters standard lengths, other lengths available on request
- Aqua colored jacket designates laser optimized multimode
- NEC OFNP, CEC FT6, RoHS compliant

**DMM10STSC**

**Application:**

- 10/100/1000/10G ethernet fiber patching
- Crestron, AMX, Savant system support
- Economical solution to field termination
- Always patch out to equipment, it is the standard

AVAILABLE LENGTHS (METERS): 1, 2, 3  
PART NUMBER LENGTH ID: 001, 002, 003

AVAILABLE JACKET COLORS: ● AQUA

## FIBERTRON DUPLEX FIBER OPTIC PATCH CABLE OM3 LASER OPTIMIZED MULTIMODE ST-ST

**Commercial**  
**PLENUM**



**Features & Benefits:**

- OM3 50/125 Laser Optimized Multimode Fiber
- Zipcord style plenum rated construction
- 2 x ST to 2 x ST Connectivity
- 1, 2, 3 meters standard lengths, other lengths available on request
- Aqua colored jacket designates laser optimized multimode
- NEC OFNP, CEC FT6, RoHS compliant

**DMM10STST**

**Application:**

- 10/100/1000/10G Ethernet Fiber Patching
- Crestron, AMX, Savant system support
- Economical solution to field termination
- Always patch out to equipment, it is the standard

AVAILABLE LENGTHS (METERS): 1, 2, 3  
PART NUMBER LENGTH ID: 001, 002, 003

AVAILABLE JACKET COLORS: ● AQUA

**THE LIBERTY** **MONEY-SAVING SERVICES!**  
**EDGE** Go to [www.LibAV.com](http://www.LibAV.com) or contact your rep today to make Liberty an extension of your workforce!

## FIBERTRON DUPLEX FIBER OPTIC PATCH CABLE OS1 SINGLE MODE LC-LC

**Commercial**  
**PLENUM**



**Features & Benefits:**

- OS1 9/125 single mode fiber
- Zipcord style plenum rated construction
- LC duplex to LC duplex connectivity
- 1, 2, 3 meters standard lengths, other lengths available on request
- Yellow colored jacket designates single mode
- NEC OFNP, CEC FT6, RoHS compliant

**DSMLCCLC**

**Application:**

- 10/100/1000/10G/40G/100G ethernet fiber patching
- A/V, data, control, phone support
- TELCO, HD security, high bandwidth signals
- Economical solution to field termination
- Always patch out to equipment, it is the standard

AVAILABLE LENGTHS (METERS): 1, 2, 3  
PART NUMBER LENGTH ID: 001, 002, 003

AVAILABLE JACKET COLORS: ● YELLOW

## FIBERTRON DUPLEX FIBER OPTIC PATCH CABLE OS1 SINGLE MODE LC-SC

**Commercial**  
**PLENUM**



**Features & Benefits:**

- OS1 9/125 single mode fiber
- Zipcord style plenum rated construction
- LC duplex to SC duplex connectivity
- 1, 2, 3 meters standard lengths, other lengths available on request
- Yellow colored jacket designates single mode
- NEC OFNP, CEC FT6, RoHS compliant

**DSMLCSC**

**Application:**

- 10/100/1000/10G/40G/100G ethernet fiber patching
- A/V, data, control, phone support
- TELCO, HD security, high bandwidth signals
- Economical solution to field termination
- Always patch out to equipment, it is the standard

AVAILABLE LENGTHS (METERS): 1, 2, 3  
PART NUMBER LENGTH ID: 001, 002, 003

AVAILABLE JACKET COLORS: ● YELLOW

## FIBERTRON DUPLEX FIBER OPTIC PATCH CABLE OS1 SINGLE MODE LC-ST

**Commercial**  
**PLENUM**



**Features & Benefits:**

- OS1 9/125 single mode fiber
- Zipcord style plenum rated construction
- LC duplex to 2 x ST connectivity
- 1, 2, 3 meters standard lengths, other lengths available on request
- Yellow colored jacket designates single mode
- NEC OFNP, CEC FT6, RoHS compliant

**DSMLCST**

**Application:**

- 10/100/1000/10G/40G/100G ethernet fiber patching
- A/V, data, control, phone support
- TELCO, HD security, high bandwidth signals
- Economical solution to field termination
- Always patch out to equipment, it is the standard

AVAILABLE LENGTHS (METERS): 1, 2, 3  
PART NUMBER LENGTH ID: 001, 002, 003

AVAILABLE JACKET COLORS: ●  
YELLOW

## FIBERTRON DUPLEX FIBER OPTIC PATCH CABLE OS1 SINGLE MODE SC-SC

**Commercial**  
**PLENUM**



**Features & Benefits:**

- OS1 9/125 single mode fiber
- Zipcord style plenum rated construction
- SC duplex to SC duplex connectivity
- 1, 2, 3 meters standard lengths, other lengths available on request
- Yellow colored jacket designates single mode
- NEC OFNP, CEC FT6, RoHS compliant

**DSMSCSC**

**Application:**

- 10/100/1000/10G/40G/100G ethernet fiber patching
- A/V, data, control, phone support
- TELCO, HD security, high bandwidth signals
- Economical solution to field termination
- Always patch out to equipment, it is the standard

AVAILABLE LENGTHS (METERS): 1, 2, 3  
PART NUMBER LENGTH ID: 001, 002, 003

AVAILABLE JACKET COLORS: ●  
YELLOW

## FIBERTRON DUPLEX FIBER OPTIC PATCH CABLE OS1 SINGLE MODE SC-ST

**Commercial**  
**PLENUM**



**Features & Benefits:**

- OS1 9/125 single mode fiber
- Zipcord style plenum rated construction
- SC duplex to 2 x ST connectivity
- 1, 2, 3 meters standard lengths, other lengths available on request
- Yellow colored jacket designates single mode
- NEC OFNP, CEC FT6, RoHS compliant

**DSMSCST**

**Application:**

- 10/100/1000/10G/40G/100G ethernet fiber patching
- A/V, data, control, phone support
- TELCO, HD security, high bandwidth signals
- Economical solution to field termination
- Always patch out to equipment, it is the standard

AVAILABLE LENGTHS (METERS): 1, 2, 3  
PART NUMBER LENGTH ID: 001, 002, 003

AVAILABLE JACKET COLORS: ●  
YELLOW

## FIBERTRON DUPLEX FIBER OPTIC PATCH CABLE OS1 SINGLE MODE ST-ST

**Commercial**  
**PLENUM**



**Features & Benefits:**

- OS1 9/125 single mode fiber
- Zipcord style plenum rated construction
- 2 x ST to 2 x ST connectivity
- 1, 2, 3 meters standard lengths, other lengths available on request
- Yellow colored jacket designates single mode
- NEC OFNP, CEC FT6, RoHS compliant

**DSMSTST**







**Application:**

- 10/100/1000/10G/40G/100G ethernet fiber patching
- A/V, data, control, phone support
- TELCO, HD security, high bandwidth signals
- Economical solution to field termination
- Always patch out to equipment, it is the standard

AVAILABLE LENGTHS (METERS): 1, 2, 3  
PART NUMBER LENGTH ID: 001, 002, 003

AVAILABLE JACKET COLORS: ●  
YELLOW



<p><b>CORNING SNAP IN FIBER OPTIC PATCH PANEL OM1 62.5/125 12 X SC SIMPLEX</b></p>  <p><b>Features &amp; Benefits:</b></p> <ul style="list-style-type: none"> <li>• 12 Simplex SC Couplers mounted in a single snap in plate</li> <li>• Color Coded for OM1 62.5/125 Multimode</li> </ul>	<p><b>CCH-CP12-56</b></p> <p><b>Application:</b></p> <ul style="list-style-type: none"> <li>• Headend Fiber Optic link management</li> <li>• A/V, Data, Control, Phone Support</li> <li>• TELCO, HD Security, High Bandwidth Signals</li> <li>• Rack Mount Fiber management and routing</li> </ul>
<p><b>CORNING SNAP IN FIBER OPTIC PATCH PANEL OM1 62.5/125 MULTIMODE 12 X ST</b></p>  <p><b>Features &amp; Benefits:</b></p> <ul style="list-style-type: none"> <li>• 12 ST Couplers mounted in a single snap in plate</li> <li>• Color Coded for OM1 62.5/125 Multimode</li> </ul>	<p><b>CCH-CP12-15T</b></p> <p><b>Application:</b></p> <ul style="list-style-type: none"> <li>• Headend Fiber Optic link management</li> <li>• A/V, Data, Control, Phone Support</li> <li>• TELCO, HD Security, High Bandwidth Signals</li> <li>• Rack Mount Fiber management and routing</li> </ul>
<p><b>CORNING SNAP IN FIBER OPTIC PATCH PANEL OM1 62.5/125 MULTIMODE 6 X LC DUPLEX</b></p>  <p><b>Features &amp; Benefits:</b></p> <ul style="list-style-type: none"> <li>• 6 Duplex LC Couplers mounted in a single snap in plate</li> <li>• Color Coded for OM1 62.5/125 Multimode</li> </ul>	<p><b>CCH-CP12-A8</b></p> <p><b>Application:</b></p> <ul style="list-style-type: none"> <li>• Headend Fiber Optic link management</li> <li>• A/V, Data, Control, Phone Support</li> <li>• TELCO, HD Security, High Bandwidth Signals</li> <li>• Rack Mount Fiber management and routing</li> </ul>
<p><b>CORNING SNAP IN FIBER OPTIC PATCH PANEL OM1 62.5/125 MULTIMODE 6 X SC SIMPLEX</b></p>  <p><b>Features &amp; Benefits:</b></p> <ul style="list-style-type: none"> <li>• Corning Snap in Fiber Optic Patch Panel OM1 62.5/125 Multimode 6 x SC</li> </ul>	<p><b>CCH-CP06-56</b></p> <p><b>Application:</b></p> <ul style="list-style-type: none"> <li>• Headend Fiber Optic link management</li> <li>• A/V, Data, Control, Phone Support</li> <li>• TELCO, HD Security, High Bandwidth Signals</li> <li>• Rack Mount Fiber management and routing</li> </ul>
<p><b>CORNING SNAP IN FIBER OPTIC PATCH PANEL OM1 62.5/125 MULTIMODE 6 X SC DUPLEX</b></p>  <p><b>Features &amp; Benefits:</b></p> <ul style="list-style-type: none"> <li>• 6 Duplex SC Couplers mounted in a single snap in plate</li> <li>• Color Coded for OM1 62.5/125 Multimode</li> </ul>	<p><b>CCH-CP12-91</b></p> <p><b>Application:</b></p> <ul style="list-style-type: none"> <li>• Headend Fiber Optic link management</li> <li>• A/V, Data, Control, Phone Support</li> <li>• TELCO, HD Security, High Bandwidth Signals</li> <li>• Rack Mount Fiber management and routing</li> </ul>
<p><b>CORNING SNAP IN FIBER OPTIC PATCH PANEL OM1 62.5/125 MULTIMODE 6 X ST</b></p>  <p><b>Features &amp; Benefits:</b></p> <ul style="list-style-type: none"> <li>• 6 ST Couplers mounted in a single snap in plate</li> <li>• Color Coded for OM1 62.5/125 Multimode</li> </ul>	<p><b>CCH-CP06-15T</b></p> <p><b>Application:</b></p> <ul style="list-style-type: none"> <li>• Headend Fiber Optic link management</li> <li>• A/V, Data, Control, Phone Support</li> <li>• TELCO, HD Security, High Bandwidth Signals</li> <li>• Rack Mount Fiber management and routing</li> </ul>

## CORNING SNAP IN FIBER OPTIC PATCH PANEL OM2 50/125 MULTIMODE 6 X LC DUPLEX

### CCH-CP12-D3



**Features & Benefits:**

- 6 Duplex LC Couplers mounted in a single snap in plate
- Color Coded for OM2 50/125 Multimode

**Application:**

- Headend Fiber Optic link management
- A/V, Data, Control, Phone Support
- TELCO, HD Security, High Bandwidth Signals
- Rack Mount Fiber management and routing

## CORNING SNAP IN FIBER OPTIC PATCH PANEL OM2 50/125 MULTIMODE 6 X SC DUPLEX

### CCH-CP12-G7



**Features & Benefits:**

- 6 Duplex SC Couplers mounted in a single snap in plate
- Color Coded for OM2 50/125 Multimode

**Application:**

- Headend Fiber Optic link management
- A/V, Data, Control, Phone Support
- TELCO, HD Security, High Bandwidth Signals
- Rack Mount Fiber management and routing

## CORNING SNAP IN FIBER OPTIC PATCH PANEL OM2 50/125 MULTIMODE 6 X SC SIMPLEX

### CCH-CP06-G6



**Features & Benefits:**

- 6 Simplex SC Couplers mounted in a single snap in plate
- Color Coded for OM2 50/125 Standard Multimode

**Application:**

- Headend Fiber Optic link management
- A/V, Data, Control, Phone Support
- TELCO, HD Security, High Bandwidth Signals
- Rack Mount Fiber management and routing

## CORNING SNAP IN FIBER OPTIC PATCH PANEL OM3/4 50/125 MULTIMODE 6 X LC DUPLEX

### CCH-CP12-E4



**Features & Benefits:**

- 6 Duplex LC Couplers mounted in a single snap in plate
- Color Coded for OM3 50/125 Laser Optimized Multimode

**Application:**

- Headend Fiber Optic link management
- A/V, Data, Control, Phone Support
- TELCO, HD Security, High Bandwidth Signals
- Rack Mount Fiber management and routing

## CORNING SNAP IN FIBER OPTIC PATCH PANEL OM3/4 50/125 MULTIMODE 6 X SC SIMPLEX

### CCH-CP06-E6



**Features & Benefits:**

- 6 Simplex SC Couplers mounted in a single snap in plate
- Color Coded for OM3 50/125 Laser Optimized Multimode

**Application:**

- Headend Fiber Optic link management
- A/V, Data, Control, Phone Support
- TELCO, HD Security, High Bandwidth Signals
- Rack Mount Fiber management and routing

## CORNING SNAP IN FIBER OPTIC PATCH PANEL OM3/4 50/125 MULTIMODE 12 X SC SIMPLEX

### CCH-CP12-E6



**Features & Benefits:**

- 12 Simplex SC Couplers mounted in a single snap in plate
- Color Coded for OM3/4 50/125 Laser Optimized Multimode

**Application:**

- Headend Fiber Optic link management
- A/V, Data, Control, Phone Support
- TELCO, HD Security, High Bandwidth Signals
- Rack Mount Fiber management and routing

## CORNING SNAP IN FIBER OPTIC PATCH PANEL OM3/4 50/125 MULTIMODE 6 X SC DUPLEX



**Features & Benefits:**

- 6 Duplex SC Couplers mounted in a single snap in plate
- Color Coded for OM3/4 50/125 Laser Optimized Multimode

**CCH-CP12-E7**

**Application:**

- Headend Fiber Optic link management
- A/V, Data, Control, Phone Support
- TELCO, HD Security, High Bandwidth Signals
- Rack Mount Fiber management and routing

## CORNING SNAP IN FIBER OPTIC PATCH PANEL OS1 SINGLE MODE 6 X LC DUPLEX



**Features & Benefits:**

- 6 Duplex LC Couplers mounted in a single snap in plate
- Color Coded for OS1 9/125 Single Mode

**CCH-CP12-A9**

**Application:**

- Headend Fiber Optic link management
- A/V, Data, Control, Phone Support
- TELCO, HD Security, High Bandwidth Signals
- Rack Mount Fiber management and routing

## CORNING SNAP IN FIBER OPTIC PATCH PANEL OS1 SINGLE MODE 6 X SC DUPLEX



**Features & Benefits:**

- 6 Duplex SC Couplers mounted in a single snap in plate
- Color Coded for OS1 9/125 Single Mode

**CCH-CP12-59**

**Application:**

- Headend Fiber Optic link management
- A/V, Data, Control, Phone Support
- TELCO, HD Security, High Bandwidth Signals
- Rack Mount Fiber management and routing

## CORNING SNAP IN FIBER OPTIC PATCH PANEL OS1 SINGLE MODE 6 X SC SIMPLEX



**Features & Benefits:**

- 6 Simplex SC Couplers mounted in a single snap in plate
- Color Coded for OS1 9/125 Single Mode

**CCH-CP06-3C**

**Application:**

- Headend Fiber Optic link management
- A/V, Data, Control, Phone Support
- TELCO, HD Security, High Bandwidth Signals
- Rack Mount Fiber management and routing

## CORNING SNAP IN FIBER OPTIC PATCH PANEL OS1 SINGLE MODE 6 X ST



**Features & Benefits:**

- 6 ST Couplers mounted in a single snap in plate
- Color Coded for OS1 9/125 Single Mode

**CCH-CP06-19T**

**Application:**

- Headend Fiber Optic link management
- A/V, Data, Control, Phone Support
- TELCO, HD Security, High Bandwidth Signals
- Rack Mount Fiber management and routing



# BARGAIN BIN PRICES DROP DAILY!

CHECK IT OUT TODAY-WHEN THEY'RE GONE, THEY'RE GONE!

[www.LibAV.com](http://www.LibAV.com)

## CORNING RACK MOUNT 1RU 2 PANEL FIBER OPTIC ENCLOSURE



### Features & Benefits:

- 1RU in height, standard 19" rack mount
- 2 Snap in Panel accomodation, up to 48 Fibers with LC panels
- Black



**INSTALLER'S CHOICE  
SNAPRAX SERIES**  
See Page: 239

## CCH-01U

### Application:

- Headend Fiber Optic link management
- A/V, Data, Control, Phone Support
- TELCO, HD Security, High Bandwidth Signals
- Rack Mount Fiber management and routing

## CORNING RACK MOUNT 2RU 4 PANEL FIBER OPTIC ENCLOSURE



### Features & Benefits:

- 1RU in height, standard 19" rack mount
- 2 Snap in Panel accomodation, up to 48 Fibers with LC panels
- Black

## CCH-02U

### Application:

- Headend Fiber Optic link management
- A/V, Data, Control, Phone Support
- TELCO, HD Security, High Bandwidth Signals
- Rack Mount Fiber management and routing

## CORNING WALL MOUNT 2 PANEL FIBER OPTIC ENCLOSURE



### Features & Benefits:

- Wall Mount Fiber Enclosure
- 2 Snap in Panel accomodation, up to 48 Fibers with LC panels
- Black

## WCH-02P

### Application:

- Headend Fiber Optic link management
- A/V, Data, Control, Phone Support
- TELCO, HD Security, High Bandwidth Signals
- Rack Mount Fiber management and routing

## CORNING WALL MOUNT 4 PANEL FIBER OPTIC ENCLOSURE



### Features & Benefits:

- Wall Mount Fiber Enclosure
- 4 Snap in Panel accomodation, up to 96 Fibers with LC panels
- Black

## WCH-04P

### Application:

- Headend Fiber Optic link management
- A/V, Data, Control, Phone Support
- TELCO, HD Security, High Bandwidth Signals
- Rack Mount Fiber management and routing

## CORNING WALL MOUNT SINGLE PANEL FIBER OPTIC ENCLOSURE



### Features & Benefits:

- Wall Mount Fiber Enclosure
- 1 Snap in Panel accomodation, up to 24 Fibers with LC panels
- Black

## SPH-01P

### Application:

- Headend Fiber Optic link management
- A/V, Data, Control, Phone Support
- TELCO, HD Security, High Bandwidth Signals
- Rack Mount Fiber management and routing

# FIBER OPTIC WALL PLATES & WebBlox® CUSTOM TOOL

Liberty provides the finishing touches for any fiber optic cable installation with our custom and stock plates solutions.

WebBlox™ design and quoting tools let you design your own wall plates from your desktop without any software.

Go from concept to completed plate design in a matter of minutes. Contact your sales professional to get started.



- Connectors:
- Quad Multi-mode LC Fiber Couplers
  - 2 Pin Phoenix Screw Terminal
  - BNC Female (75 Ohm)



- Connectors:
- Duplex Multi-mode LC Fiber Couplers
  - 2 Pin Phoenix Screw Terminal





**PANEL CRAFTERS**  
CUSTOM PLATES & PANELS

# CUSTOM PLATES & PANELS

**RUN WITH US**

## SERVICES THAT ADD VALUE

### Go the Distance with PanelCrafters™

With the connectivity of Intelix, you can now get your traditional A/V signals extended – while still combining the existing A/V components from PanelCrafters. Check out the Intelix section on page 143 to review the line of Intelix wall-plate options, and use WebBlox or CadBlox to create your own faceplate for each.

The AVO series of Decor plates can be direct mounted to our traditional anodized and painted aluminum wall-plates – add more connectors and even your logo to truly customize your install. The Digi-series can also be direct mounted onto a 2 gang or larger plate.

Check out the specs in the Intelix section, and login to WebBlox or download CadBlox to get started.

### Delivery

With stock plates in Colorado and North Carolina, PanelCrafters can get you the plate you need fast. Our standard catalog items are available in a 48 hour production run (when not in stock), and our custom plates ship as fast as the next business day with an expedite fee.

Standard turn times for custom wall, floor, and rack plates are 5-7 business days. Custom fabricated items are 7-10 business days. Specialty items or higher volume orders will be coordinated with you at time of order.

Have a larger project? Make sure you coordinate with your salesperson to pass along as many details as possible. We have special project pricing, and extended discounts and freight options to make sure we create as much value possible for your install.



### PLATES & PANELS DELIVERY

Get priority with expedited delivery on plates and panels to get the job done faster

### CUSTOM PLATE DESIGN & PRINTING

Customize plates for your installation. Print dealer logo and contact info to get advertising and repeat business

SEE PAGE 218 FOR MORE DETAILS!



### CUSTOM KITTING

Streamline your installs with a pre-packaged kit of everything you need

### Super-Custom

Have a box you need to fit multiple pieces into? Some old console that needs an upgraded control system? With PanelCrafters fabrication services, we can combine multiple devices into one easy to install custom panel. Touchscreens, XLR's, extenders, and more can be combined onto one panel to consolidate space in a Rack – or just to create an easier to use solution for you and your customer.

### Connectors

Shallow box? No Problem! With the combination of Liberty's cable sources, and the manufacturing solutions of PanelCrafters – we've created numerous pigtail connectors to simplify your install. HDMI and USB options are the most popular, and even a simple stereo mini connector can help save space when you need to.

# DESIGN & QUOTING SOFTWARE TOOLS

**WebBlox** is the premier custom plate and panel design tool in the AV industry. This free design and quoting tool gives you complete control over designing your own custom plate and panel layouts. All of PanelCrafters' standard panel sizes are available via simple drop-down boxes. Drag-and-drop any of our standard connectors into your design, specify the text you want, even add your logo, all in WebBlox's user-friendly environment. All of the panels you design are stored in your password protected account.

WebBlox even provides a personalized proof page that you can print and provide to your customer for approval. Best of all, once your account is approved you'll have instant access to the part number and your dealer pricing for all the plates you design.

WebBlox requires no expensive software or hardware, just a web browser and internet connection. This flexible design tool allows you to design, quote and proof your plate designs from your desktop 24 hours a day. When you're ready to order, submit as you would for any other order using the part number and pricing from your WebBlox account.

## WebBlox®

GO FROM CONCEPT  
TO COMPLETED PLATE  
DESIGN IN MINUTES!



- FREE SERVICE
- DESIGN ONLINE 24/7
- PASSWORD PROTECT YOUR DESIGNS
- ADD YOUR OWN LOGO
- SUPER EASY DRAG-&-DROP INTERFACE



**UK STYLE PLATES  
& INTERNATIONAL  
SIZES AVAILABLE**



- Designed and engineered to fit 46mm deep single gang and double gang British Standard backboxes.
- Available in several plastic and metal finishes including white, brushed aluminium and antique black. Other finishes available upon request.

**Prefer to work in AutoCAD or Visio? We have a solution for you as well...**



**CADBlox** is an AutoCAD block library. It contains pre-engineered blocks for all of our standard connectors and panel sizes. Using the alignment grids designed into the panel blocks along with AutoCAD's "OSNAP" makes designing your custom plates and panels a "Snap". A full or LT version of AutoCAD is required to use this library.



**CADQuote** is a companion application for experienced CADBlox users. It allows CADBlox users to generate quotes from their custom panel designs and save them in their password protected account. Proofs are also auto-generated and include material listings (BOM's) for each panel. Quote pages can be generated (for purchasing) combining any quantity of parts stored in your account. A full version of AutoCAD is required to run this application.



# QUOTES AND UP-FRONT PROOFING

PanelCrafters™ offers the most streamlined and accurate proofing process in the industry. Proofs are consistent between our on-line quoting programs and quotes produced by PanelCrafters staff. PanelCrafters up-front proofing process makes the quote-to-order process fast and easy.



Up-front proofing ensures that we produce your panels exactly as you requested so your highest quality plates and panels are on-time – every time. Requests that include non-stock materials or require additional

engineering may be quoted and returned without design proofs. When ordered, these parts will be engineered and proofs will be submitted prior to production. No ordered product can be manufactured without your signed proof.

QTY	PN	Description
1	R334E	CAT 6 RJ-45 F04THRU CAT5E COMPATIBLE
1	PM-48A	BALUN, USB 2.0 FS SK UNIT
1	PM-48E	BALUN, USB 2.0 FS TX UNIT
1	Y6	HD-15 FEMALE FREETHRU
1	F9	ISOLATED 3.5MM STEREO-MINI PASSTHRU
1	V57	HDMI FEM TO FEM W/SH-TAIL

Company Name	Liberty Wire & Cable
Project Name	LIBER-C063318-1
Part Number	LIBER-C063318-1
Material Code	Clear Anodize
Plate Color	Black
Panel Size	2GANG
Designated Date	24
Designed by	rnorris
Date	01-31-2013
Scale	NES
Sheet	1/1

- 1 Approval box for you to sign when ordering plates
- 2 Itemized material list including connector descriptions and any special notes
- 3 Precise graphical representation of the finished plate  
Lead time and pricing breakdowns by requested quantity
- 4 Company and project reference information (provided by you)  
Full dimensions are shown when needed to ensure accuracy
- 5 Unique part number for each plate or panel design  
(for easy ordering and reordering)
- 6 Plate specifications including plate color and finish



**Need Help?**  
Call or Email!  
[sales@panelcrafters.com](mailto:sales@panelcrafters.com)  
800.530.8998



# PLATE & PANEL SURFACE FINISHES



## ANODIZED

PanelCrafters recommends clear anodized (brushed aluminum) and black anodized, our most common finishes, for typical commercial applications. They provide unsurpassed quality and appearance. Gold anodized and brushed brass finishes are also available for special applications.



## STAINLESS STEEL

PanelCrafters offers stainless steel 1 through 6 gang plates for the ultimate in strength and durability.



## SPECIALTY

PanelCrafters offers a variety of specialty finishes including digitally printed polycarbonate overlays. This capability provides unequalled color and pattern matching capabilities. Provide your own artwork or let our graphic design department assist you with your special project needs. Our overlays are reverse printed making the full color image scratch and wear proof.

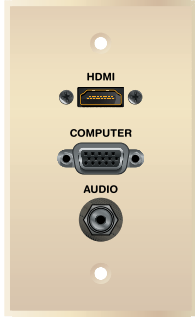

## PLASTIC/NYLON

PanelCrafters offers black, white, ivory and almond in nylon 1 & 2 gang plates and decora inserts.

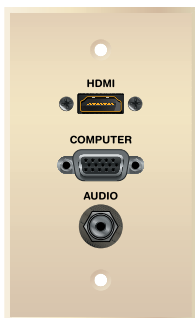

## PAINTED/POWERCOATED

PanelCrafters offers white, ivory and almond in flat painted plates. For increased durability we recommend powder coated finishes, available in Textured Black, Textured White, Textured Grey, Smooth White, Smooth Almond, Smooth Ivory Custom color matching is available.

# PREWIRED PLATES & PANELS



Have Liberty **prewire plates and panels** to save time, money and ease installation. Liberty's full service custom cable assembly department can incorporate short leads on plates all the way up to multi-foot prewired assemblies and snakes cables.

All cable assemblies are fully tested prior to arriving at your job site. Liberty's custom cable assemblies offer professional appearance and leads can be numerically identified to ease installation.

Cable assembly ends can be tinned, blunt cut, or terminated with the appropriate connector. Cable assembly termination proof is provided to customers prior to manufacturing.

Our plates and panels can be delivered fully wired with any length and style of cable that is required for your project. Many customers find our turnkey prewired options to be a convenient and effective solution.



*Liberty's Cable Assembly Team*



## Flanged Panels and Soldering

Let Liberty solder jumpers between connectors create an easier installation. Flanged Panels are available made by PanelCrafters™ or we can machine into stock Middle Atlantic Panels or other customer supplied panels.



# CUSTOM PLATE SIZES

## ACE Half Pocket Style



**CBUF1**  
3 11/16" x 4 1/2"

**DID YOU KNOW?**

ACE Super Pocket Style  
Also Available

## ACE Full Pocket Style



**CBUF2**  
7 3/8 x 4 1/2

## Steel City Floor Box Size



**AFP-6B60**  
9" x 3 1/2"

**DID YOU KNOW?**

All sizes available in Clear and Black Anodize

## Steel City Floor Box Size



**AFP-4B60**  
6" x 3 1/2"

## Nema Style (shown in table)

all sizes available in Clear and Black Anodize



**CCUN6 & CCUN6** 6" x 6"  
Available in Black and Clear Anodized

Plate Size	Box Size	Color	P/N
6 x 6	6 x 6	Clear Anodized	CCUN6
7 x 7	6 x 6	Clear Anodized	CCUN7
8 x 8	8 x 8	Clear Anodized	CCUN8
9 x 9	8 x 8	Clear Anodized	CCUN9
10 x 10	10 x 10	Clear Anodized	CCUN0
11 x 11	10 x 10	Clear Anodized	CCUN1
12 x 12	12 x 12	Clear Anodized	CCUN2
13 x 13	12 x 12	Clear Anodized	CCUN3

## FSR FL-1500 Style



**CCUF6**  
8 7/8" x 6 3/16"

## Custom Fabrication

PanelCrafters™ can manufacture a plate of any size or dimension to fit your specific needs.



**DID YOU KNOW?**

We specialize in odd sizes!

## Mystery Moduline Style



**CBUF3**  
4 1/2" x 2 1/2"

# CUSTOM PLATES & PANELS

PanelCrafters® rack panels are perfect for corporate board rooms, medical facilities, home theater systems, control systems or anywhere you want specific connectivity for your installation. Combine several standard rack panels into one larger panel for a clean custom appearance to your project.

Add engraving and screen printing options to customize your connectivity and brand your work. Used in a broad base of commercial and residential applications, PanelCrafters® rack panels add a professional finish, brand your company and provide easy connectivity that improves your profitability on every job.



Custom Panels



Standard Rack Panels



Hinged Rack Panels



Broadcast Plates & Panels



# RACK HEADERS – RHCB & RHIM

## What's the difference?

- RHCB is multi-color, screen-printed, 2-part epoxy – directly printed to an anodized aluminum panel w/ a brushed finish to blend in with other rack components and accessories.
- RHIM is CMYK Digital graphics on the reverse side of clear polycarbonate. This allows for more complicated images and graphic content, and this digital output is attached to an unfinished aluminum panel for rigidity.



## Get started!

Simply email a high-resolution copy of the logo to sales@panelcrafters.com – a custom quote # / part will be assigned based on the best production method for the logo. (Screen-printed vs. Digitally Printed)

## Artwork guidelines:

- Adobe Illustrator (vector art) - Preferably saved as version 10 or below, CS or CS2. Please convert all text to outlines or curves, or provide fonts used.
- Adobe Photoshop (raster art) - 300 dpi (ppi) or higher, at actual size to be used, TIF or JPG format preferred.
- Adobe Acrobat (PDF)
- We can also accept other types of digital files, with little or no difficulty, but there are certain types which we cannot use as a logo file:
  - Powerpoint
  - Word (Logo will have to be recreated, adding to art time)
  - Publisher
  - There are other programs that make .JPG, .EPS, and similar vector art/raster art filetypes. Examples like CorelDraw, Freehand, Paint Shop Pro. If sending these, please let us know what program(s) it was created in, to help us determine if we can convert it. And if it is a vector art program, please convert all text to outlines or curves, or provide fonts used.
  - All art should be saved as CMYK, and not RGB.
  - Spot colors are ok, but we will need a listing of spot colors that were used

## Where's my proof?

- A production proof will be provided 24-48 hours after placing your order – this proof can be changed an unlimited number of times before we release to production. Subsequent changes after the first build will require a new part number established.

Show the quality and pride that went into your installations! These permanent calling cards make it easy for your customer to contact you for future projects and upgrades. They let everyone know you're proud of the work you do.



# ALTERNATIVE GANG PLATE OPTIONS

PanelCrafters™ offers a variety of **custom gang plate options** including: plastic and aluminum decora inserts, stainless steel plates and international configurations.

## Plastic and Decora Style

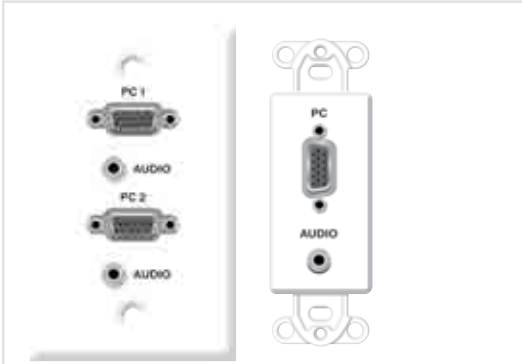

PanelCrafters™ **unique packaging** is designed so that you can more easily manage and view your panel and plate inventories. A CAD drawing is located on the top of the package with an additional information label on the side of each package. The information label is also printed with the name of your particular job or the application that you are working on. In addition, the label can also be printed with the job number and/or

All custom gang plates are available populated with connectors and in a variety of colors and finishes. Contact your professional sales representative for more information.

## Stainless Steel Plates



your P.O. number so that the product can be quickly tracked and registered for cost accounting purposes.

Our packaging protects the plate surface and installed connectors during shipping and storage. The front and back of each package is open, which allows for easy viewing and inspection of the product face and back. These features allow for enhanced inventory and project management.

## Easy Identification Without Unwrapping



CAD Drawings and Part Numbers on Our Labels Make Product Identification Easy

Front and Back of Packages are Open for Easy Viewing and Inspection



# HDMI ADAPTER RING

Keep your adapters where they need to be & immediately accessible for your mobile content presentation podium, boardroom, or docking station!

**DL-AR**

**PERFECT FOR:**

- Adapting various mobile content devices to HDMI
- Interfacing Laptops, Macs, iPad, Smartphone to HDMI

SEE PAGE 132



**DIGITALINX™**

# PANELCRAFTERS STOCK PLATES

**PanelCrafters®** single and double gang plates provide a wide variety of A/V solutions to accommodate both commercial and residential installations. Combining form and function, our selection of gang plates provide high-quality solutions for your device-to-device or device-to-control connections needs. Our at-a-glance guide provides you with an easy-to-use snapshot of our single and double gang plate product offerings. If your project or application requires a plate that is not listed in our guide, we can design and manufacture a custom plate for you that matches the exact specifications of your project. Contact us for details.

**Adapter plates** have a variety of termination styles which convert pass thru connectors to captive screw, breakout and other terminating options. Please see plate pictures and descriptions for details.

**Change or remove text** on any catalog plate and/or add your company logo screen-printed for a nominal fee. Quantity discount available when ordering multiple stock plates with text changes. Custom logos require a one-time art set-up fee for design, tooling and color match. Please contact your sales representative for details. Ordering the right plate style for your application is super easy! Of course you can add a logo without any hassles.



Add Logos

# PANELCRAFTERS PART NUMBER KEY

## EZ-Build Stock Plate Part Numbers

Ordering the right plate style for your application is super easy!



PC-G1020-E-P-C-L

### Example

You need a single gang plate with pass through connectors, and the plate should have engraved text and be on clear aluminum.

The picture to the left shows what the product will look like and as one follows the arrow to the right choosing the right option is a snap.

Of course you can change the text and add a logo without any hassles.

## STANDARD PLATES PART NUMBER KEY

### BASE PART NUMBER

**PC-G1020-E-P-C-L** ADD LOGO CUSTOM

#### PLATE TYPE

- G: STANDARD GANG
- A: ACTIVE PLATE
- EZ: EDULINX
- B: BALUNS (O CAT)
- P: PASSIVE DEVICE
- U: UK OR EURO SIZE

#### CONNECTOR TYPE

- P: PASTHROUGH
- S: SOLDERBACK
- M: MIXED CONTACT
- RX: RECEIVE
- TX: TRANSMIT

#### PRINTING OPTIONS

- E: ENGRAVED
- S: SCREEN PRINTED
- C: CUSTOM TEXT

#### METAL OPTIONS

- C: CLEAR ANODIZED
- B: BLACK ANODIZED
- W: SMOOTH WHITE PAINT
- E: TEXTURED WHITE
- K: TEXTURED BLACK
- Y: TEXTURED GREY
- I: SMOOTH IVORY
- A: SMOOTH ALMOND
- O: BROWN
- S: STAINLESS STEEL
- M: LIGHT ALMOND

## XLR 3-PIN FEMALE SOLDER BACK



AUDIO FACEPLATE | **PC-G1300**

### Features and Benefits:

- Precision manufactured plate
- XLR female with solder back connectivity
- Single gang format
- Durable heavy duty metal construction

### Application:

- Single faceplate support for microphone hookup
- Line level audio, mic level audio
- XLR 3-Pin female

## DUAL XLR 3-PIN FEMALE SOLDER BACK



AUDIO FACEPLATE | **PC-G1320**

### Features and Benefits:

- Precision manufactured plate
- Twin XLR female with solder back connectivity
- Single gang format
- Durable heavy duty metal construction

### Application:

- Single faceplate support for microphone hookup
- Line level audio, mic level audio
- twin XLR 3-Pin female

## QUAD XLR 3-PIN FEMALE SOLDER BACK



AUDIO FACEPLATE | **PC-G2320**

### Features and Benefits:

- Precision manufactured plate
- Quad XLR female with solder back connectivity
- Double gang format
- Durable heavy duty metal construction

### Application:

- Single faceplate support for microphone hookup
- Line level audio, mic level audio
- Four XLR 3-Pin female

## TRIPLEX RCA AUDIO/VIDEO PASS-THROUGH



AUDIO/VIDEO FACEPLATE | **PC-G1240**

### Features and Benefits:

- Precision manufactured plate
- Triplex RWY RCA pass-through connectivity
- Single gang format
- Durable heavy duty metal construction

### Application:

- Single faceplate support for A/V
- Single pull education, boardroom installations
- Triplex RCA Red, White, and Yellow

## BULK WIRE PLATE WITH 3/8 INCH GROMMET HOLE



BULK WIRE FACEPLATE | **PC-G1900**

### Features and Benefits:

- Precision manufactured plate
- 3/8 inch pass-through hole with rubber grommet
- Single gang format
- Durable heavy duty metal construction

### Application:

- Single faceplate for bulk wire pull
- Feed cables through walls without cutting or adding junctions
- 3/8" hole with protective grommet

## BULK WIRE PLATE WITH 5/8 INCH GROMMET HOLE



BULK WIRE FACEPLATE | **PC-G1920**

### Features and Benefits:

- Precision manufactured plate
- 5/8 inch pass-through hole with rubber grommet
- Single gang format
- Durable heavy duty metal construction

### Application:

- Single faceplate for bulk wire pull
- Feed cables through walls without cutting or adding junctions
- 5/8" hole with protective grommet



## BULK WIRE PLATE WITH 1 INCH GROMMET HOLE



BULK WIRE FACEPLATE | **PC-G1940**

### Features and Benefits:

- Precision manufactured plate
- 1 inch pass-through hole with rubber grommet
- Single gang format
- Durable heavy duty metal construction

### Application:

- Single faceplate for bulk wire pull
- Feed cables through walls without cutting or adding junctions
- 1" hole with protective grommet

## BULK WIRE PLATE WITH 1 7/8TH INCH GROMMET HOLE



BULK WIRE FACEPLATE | **PC-G1960**

### Features and Benefits:

- Precision manufactured plate
- 1 7/8 inch pass-through Oval hole with rubber grommet
- Single gang format
- Durable heavy duty metal construction

### Application:

- Single faceplate for bulk wire pull
- Feed cables through walls without cutting or adding junctions
- 1 7/8" Oval hole with protective grommet

## BULK WIRE PLATE WITH 1 1/2 INCH GROMMET HOLE



BULK WIRE FACEPLATE | **PC-G2900**

### Features and Benefits:

- Precision manufactured plate
- 1 1/2 inch pass-through hole with rubber grommet
- Double gang format
- Durable heavy duty metal construction

### Application:

- Single faceplate for bulk wire pull
- Feed cables through walls without cutting or adding junctions
- 1 1/2" hole with protective grommet

## F-81 F-CONNECTOR FEMALE PASS-THROUGH



CATV FACEPLATE | **PC-G1800**

### Features and Benefits:

- Precision manufactured plate
- F connector female pass-through, 1.0 GHz
- Single gang format
- Durable heavy duty metal construction

### Application:

- Single faceplate support for CATV or MATV
- Cable TV, municipal TV, security video
- F female

## TRIPLEX RCA AUDIO/VIDEO PASS-THROUGH PLATE INSERT



DECORATOR PLATE INSERT | **PCD-5000**

### Features and Benefits:

- Decorator plate insert
- Red, white, yellow RCA pass-through jacks
- White

### Application:

- Audio/Video signal routing and interconnection
- Decorator convenience outlet for A/V Distribution



**New Website**  
[www.LibAV.com](http://www.LibAV.com)  
**BETTER, STRONGER, EXPANSIVE!**

## VGA AND 3.5MM STEREO PASS-THROUGH PLATE INSERT



DECORATOR PLATE INSERT | **PCD-5100**

### Features and Benefits:

- Decorator plate insert
- VGA and 3.5mm TRS pass-through jacks
- Black

### Application:

- VGA and Audio signal routing and interconnection
- Decorator convenience outlet for VGA+audio distribution

## 5-RCA COMPONENT AND L/R AUDIO PASS-THROUGH PLATE INSERT



DECORATOR PLATE INSERT | **PCD-5280**

### Features and Benefits:

- Decorator plate insert
- Green, red, blue and red and white RCA pass-through jacks
- White

### Application:

- Triplex RCA component video and duplex RCA audio
- Compatible with RGBHV video if needed
- Decorator convenience outlet for A/V Distribution

## XLR 3-PIN FEMALE SOLDER BACK PLATE INSERT



DECORATOR PLATE INSERT | **PCD-5750**

### Features and Benefits:

- Decorator plate insert
- Neutrik XLR 3-pin female to solder back connectivity
- Black

### Application:

- Mono balanced audio, microphone audio
- Stereo unbalanced audio, RS-232C
- Decorator convenience outlet for Audio

## HDMI PASS-THROUGH PLATE INSERT



DECORATOR PLATE INSERT | **PCD-5850**

### Features and Benefits:

- Decorator plate insert
- HDMI pass-through port mounted
- White



**HDMI MOBILE ADAPTER RING GENIUS!**

See Page: 132

### Application:

- HDMI signal routing and interconnection
- Compatible with DVI-D single link
- Decorator convenience outlet for HDMI distribution

## EDULINX INTERCONNECTION SYSTEM 2 VIDEO 2 AUDIO



EDULINX® FACEPLATE | **PC-EZ1000**

### Features and Benefits:

- DIN 13 male to VGA+3.5TRS and triplex RCA audio/video faceplate
- Single gang format
- Mono audio only, no stereo
- This is the faceplate attachment with turret design
- Durable heavy duty metal construction

### Application:

- Single pull education, boardroom installations
- Quick Installation component with matching cables
- Labor and bill of material savings in mass installs

## EDULINX INTERCONNECTION SYSTEM 2 VIDEO 2 AUDIO PLUS NETWORK



EDULINX® FACEPLATE | **PC-EZ1260**

### Features and Benefits:

- DIN 13 male to VGA+3.5TRS and triplex RCA audio/video faceplate
- LAN pass-through coupler included
- Single gang format
- Mono audio only, no stereo
- Faceplate attachment with turret design
- Durable heavy duty metal construction

### Application:

- Single pull education, boardroom installations
- Quick Installation component with matching cables
- Labor and bill of material savings in mass installs

## HDMI FEMALE PASS-THROUGH

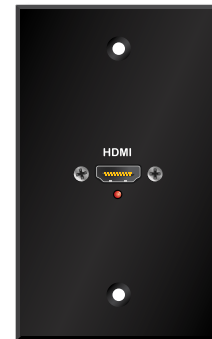

HDMI FACEPLATE | **PC-G1790**

### Features and Benefits:

- Precision manufactured plate
- HDMI female pass-through connectivity
- Single gang format
- Durable heavy duty metal construction

### Application:

- Single faceplate support for HDMI
- Passive pass-through, use of equalizer or booster recommended
- HDMI female

## HDMI, VGA, AND 3.5MM TRS FEMALE PASS-THROUGH



HDMI FACEPLATE | **PC-G1795**

### Features and Benefits:

- Precision manufactured plate
- HDMI, VGA, and 3.5mm TRS female pass-through connectivity
- Single gang format
- Durable heavy duty metal construction

### Application:

- For HDMI and VGA with audio
- HDMI digital multimedia and projector support
- VGA Video and stereo unbalanced or mono balanced audio
- HDMI female, VGA female, 3.5mm TRS female

## LAN PASS-THROUGH



LAN / DATA FACEPLATE | **PC-G1660**

### Features and Benefits:

- Precision manufactured plate
- Cat6 LAN pass-through connectivity
- Single gang format
- Durable heavy duty metal construction

### Application:

- Single faceplate support for LAN support
- 10/100/1000BaseT Ethernet
- RJ45 Category 6 backwards compatible to Category 5e

## 4-POLE SPEAKON® FAST TAB OR SCREW BACK



SPEAKER FACEPLATE | **PC-G1350**

### Features and Benefits:

- Precision manufactured plate
- 4-Pole SpeakON® with fast tab or screw down connectivity
- Single gang format
- Durable heavy duty metal construction

### Application:

- Single faceplate support for Speaker hookup
- 2 speaker or bi-wire format support
- SpeakON® Male panel connector

## USB A-B PASS-THROUGH



USB FACEPLATE | **PC-G1760**

### Features and Benefits:

- Precision manufactured plate
- USB A to B pass-through connectivity
- Single gang format
- Durable heavy duty metal construction

### Application:

- Single faceplate support for USB 1.1, 2.0
- USB Control
- USB A female on front, B female on back

## VGA+3.5TRS AND TRIPLEX RCA A/V PASS-THROUGH



VGA FACEPLATE | **PC-G1000**

### Features and Benefits:

- Precision manufactured plate
- VGA+3.5TRS and triplex RCA audio/video pass-through connectivity
- Single gang format
- Durable heavy duty metal construction

### Application:

- Single faceplate support for 2 video and 2 audio channels
- Single pull education, boardroom installations
- VGA+3.5TRS stereo audio and triplex RCA A/V

## VGA+3.5TRS, TRIPLEX RCA A/V, AND S-VIDEO PASS-THROUGH



VGA FACEPLATE | **PC-G1020**

### Features and Benefits:

- Precision manufactured plate
- VGA+3.5TRS, triplex RCA audio/video, S-video pass-through connectivity
- Single gang format
- Durable heavy duty metal construction

### Application:

- Single faceplate support for 3 video and 2 audio channels
- Single pull education, boardroom installations
- VGA+3.5TRS stereo audio and triplex RCA A/V
- S-video

## 2 VGA+ 2 3.5TRS PASS-THROUGH



VGA FACEPLATE **PC-G1140**

### Features and Benefits:

- Precision manufactured plate
- Two VGA and two 3.5TRS pass-through connectivity
- Single gang format
- Durable heavy duty metal construction

### Application:

- Single faceplate support for 2 video and 2 audio channels
- Single pull education, boardroom installations
- Twin VGA with twin PC stereo Audio

## VGA+3.5TRS, TRIPLEX RCA A/V, AND LAN PASS-THROUGH



VGA FACEPLATE **PC-G1260**

### Features and Benefits:

- Precision manufactured plate
- VGA+3.5TRS, triplex RCA audio/video, and LAN pass-through connectivity
- Single gang format
- Durable heavy duty metal construction

### Application:

- Single faceplate support for 2 video and 2 audio channels
- Single pull education, boardroom installations
- VGA+3.5TRS stereo audio, triplex RCA A/V, LAN

## VGA TO 5 BNC FEMALE AND A 3.5TRS TO TERMINAL BLOCK



CUSTOM VGA FACEPLATE **PC-G1520**

### Features and Benefits:

- Precision manufactured plate
- VGA female with 5 BNC female pigtail, 3.5 TRS to terminal block connectivity
- Single gang format
- Durable heavy duty metal construction

### Application:

- Single faceplate support for VGA+audio
- RGBHV video and stereo unbalanced or mono balanced audio
- VGA to RGBHV, 3.5mm to terminal block

## VGA AND COMPOSITE VIDEO RCA PASS-THROUGH



VGA FACEPLATE **PC-G1540**

### Features and Benefits:

- Precision manufactured plate
- VGA female and yellow RCA female pass-through connectivity
- Single gang format
- Durable heavy duty metal construction

### Application:

- Single faceplate support for VGA and composite video
- VGA video and composite video
- VGA video and S/PDIF digital audio
- VGA female and yellow RCA female pass-through

## VGA, 3.5TRS, AND LAN PASS-THROUGH



VGA FACEPLATE **PC-G1600**

### Features and Benefits:

- Precision manufactured plate
- VGA female, 3.5mm TRS, Cat6 LAN pass-through connectivity
- Single gang format
- Durable heavy duty metal construction

### Application:

- Single faceplate support for VGA+audio+LAN
- VGA video and stereo unbalanced or mono balanced audio
- Category 5e or Category 6 pass-through coupler
- VGA female, 3.5mm TRS, Cat6 LAN

## VGA AND LAN PASS-THROUGH



VGA FACEPLATE **PC-G1620**

### Features and Benefits:

- Precision manufactured plate
- VGA female and Cat6 LAN pass-through connectivity
- Single gang format
- Durable heavy duty metal construction

### Application:

- Single faceplate support for VGA and LAN
- VGA video and Category 5e or 6 LAN
- VGA female and Cat6 LAN

## VGA PASS-THROUGH



VGA FACEPLATE | **PC-G1720**

- Features and Benefits:**
- Precision manufactured plate
  - VGA female pass-through connectivity
  - Single gang format
  - Durable heavy duty metal construction

- Application:**
- Single faceplate support for VGA
  - VGA video
  - VGA female

## VGA, 3.5TRS, AND USB PASS-THROUGH



VGA FACEPLATE | **PC-G1765**

- Features and Benefits:**
- Precision manufactured plate
  - VGA female, 3.5mm TRS, USB A-A pass-through connectivity
  - Single gang format
  - Durable heavy duty metal construction

- Application:**
- Single faceplate support for VGA+audio+USB
  - VGA video and stereo unbalanced or mono balanced audio
  - USB control
  - VGA female, 3.5mm TRS, USB A-A female

## DUAL VGA+3.5TRS AND TRIPLEX RCA A/V PASS-THROUGH



VGA FACEPLATE | **PC-G2000**

- Features and Benefits:**
- Precision manufactured plate
  - Two VGA+ two 3.5TRS, triplex RCA audio/video, and LAN pass-through connectivity
  - Double gang format
  - Durable heavy duty metal construction

- Application:**
- Single faceplate support for 4 video and 3 audio channels
  - Single pull education, boardroom installations
  - Dual VGA+3.5TRS stereo audio, single triplex RCA A/V

## VGA+3.5TRS AND TRIPLEX RCA A/V PASS-THROUGH



VGA FACEPLATE | **PC-G2020**

- Features and Benefits:**
- Precision manufactured plate
  - VGA+3.5TRS and triplex RCA audio/video pass-through connectivity
  - Double gang format
  - Durable heavy duty metal construction

- Application:**
- Single faceplate support for 2 video and 2 audio channels
  - Single pull education, boardroom installations
  - VGA+3.5TRS stereo audio and triplex RCA A/V

## VGA+3.5TRS, TRIPLEX RCA A/V, AND LAN PASS-THROUGH



VGA FACEPLATE | **PC-G2120**

- Features and Benefits:**
- Precision manufactured plate
  - VGA+3.5TRS, triplex RCA audio/video, and LAN pass-through connectivity
  - Double gang format
  - Durable heavy duty metal construction

- Application:**
- Single faceplate support for 2 video and 2 audio channels
  - Single pull education, boardroom installations
  - VGA+3.5TRS stereo audio, triplex RCA A/V, LAN

# WebBlox®



## CUSTOM PLATE DESIGN IN JUST MINUTES!

- ADD YOUR OWN LOGO
- DESIGN ONLINE, 24/7
- FREE SERVICE, PASSWORD PROTECT YOUR DESIGNS

Check it out at [www.LibAV.com](http://www.LibAV.com) or scan the code for a direct link!



Get complete control over designing your own custom plate and panel layouts. All PanelCrafters® standard panel sizes are available.

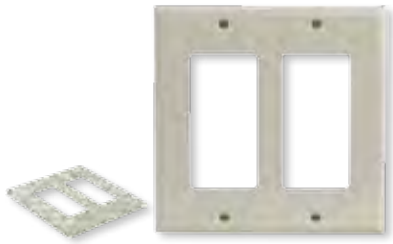

## KEYSTONE DECORATOR STYLE 2 GANG SMOOTH FACEPLATE

<b>Keystone Faceplates</b>	<b>NON-PLENUM</b>	<b>WP-DEC2</b>
<b>Features &amp; Benefits:</b>		<b>Application:</b>
<ul style="list-style-type: none"> <li>· Decorator format double gang 2-port smooth face</li> <li>· White, almond, and ivory</li> <li>· UL listed communication circuit accessory</li> </ul>		<ul style="list-style-type: none"> <li>· Decorator format wall plate</li> <li>· Convenience outlet management for structured solutions</li> <li>· Keystone inserts for audio, video, LAN, speaker, and phone</li> </ul>
AVAILABLE COLORS: <input type="checkbox"/> WHITE <input type="checkbox"/> ALMOND <input type="checkbox"/> IVORY		



## KEYSTONE DECORATOR STYLE 2-PORT FACEPLATE INSERT

<b>Keystone Faceplates</b>	<b>NON-PLENUM</b>	<b>WJ-DEC</b>
<b>Features &amp; Benefits:</b>		<b>Application:</b>
<ul style="list-style-type: none"> <li>· Decorator insert with two empty keystone ports</li> <li>· White, almond, and ivory</li> <li>· UL listed communication circuit accessory</li> </ul>		<ul style="list-style-type: none"> <li>· Decorator format wall plate</li> <li>· Convenience outlet management for structured solutions</li> <li>· Keystone inserts for audio, video, LAN, speaker, and phone</li> </ul>
AVAILABLE COLORS: <input type="checkbox"/> WHITE <input type="checkbox"/> ALMOND <input type="checkbox"/> IVORY		



## KEYSTONE DECORATOR STYLE 3 GANG SMOOTH FACEPLATE

<b>Keystone Faceplates</b>	<b>NON-PLENUM</b>	<b>WP-DEC3</b>
<b>Features &amp; Benefits:</b>		<b>Application:</b>
<ul style="list-style-type: none"> <li>· Decorator format 3 Gang 2-port smooth face</li> <li>· White, almond, and ivory</li> <li>· UL listed communication circuit accessory</li> </ul>		<ul style="list-style-type: none"> <li>· Decorator format wall plate</li> <li>· Convenience outlet management for structured solutions</li> <li>· Keystone inserts for audio, video, LAN, speaker, and phone</li> </ul>
AVAILABLE COLORS: <input type="checkbox"/> WHITE <input type="checkbox"/> ALMOND <input type="checkbox"/> IVORY		

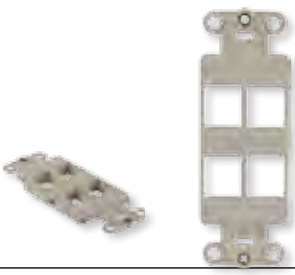

## KEYSTONE DECORATOR STYLE 4-PORT FACEPLATE INSERT

<b>Keystone Faceplates</b>	<b>NON-PLENUM</b>	<b>WJ-DEC4</b>
<b>Features &amp; Benefits:</b>		<b>Application:</b>
<ul style="list-style-type: none"> <li>· Decorator insert with four empty keystone ports</li> <li>· White, almond, and ivory</li> <li>· UL listed communication circuit accessory</li> </ul>		<ul style="list-style-type: none"> <li>· Decorator format wall plate</li> <li>· Convenience outlet management for structured solutions</li> <li>· Keystone inserts for audio, video, LAN, speaker, and phone</li> </ul>
AVAILABLE COLORS: <input type="checkbox"/> WHITE <input type="checkbox"/> ALMOND <input type="checkbox"/> IVORY		

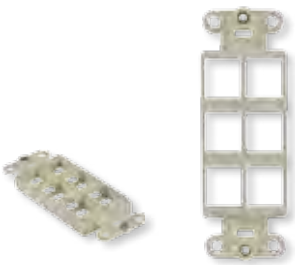

## KEYSTONE DECORATOR STYLE 6-PORT FACEPLATE INSERT

<b>Keystone Faceplates</b>	<b>NON-PLENUM</b>	<b>WJ-DEC6</b>
<b>Features &amp; Benefits:</b>		<b>Application:</b>
<ul style="list-style-type: none"> <li>· Decorator insert with six empty keystone ports</li> <li>· White, almond, and ivory</li> <li>· UL listed communication circuit accessory</li> </ul>		<ul style="list-style-type: none"> <li>· Decorator format wall plate</li> <li>· Convenience outlet management for structured solutions</li> <li>· Keystone inserts for audio, video, LAN, speaker, and phone</li> </ul>
AVAILABLE COLORS: <input type="checkbox"/> WHITE <input type="checkbox"/> ALMOND <input type="checkbox"/> IVORY		



# WebBlox®

## CUSTOM PLATE DESIGN



[www.LibAV.com](http://www.LibAV.com)

- ADD YOUR OWN LOGO
- FREE SERVICE, PASSWORD PROTECT YOUR DESIGNS
- DESIGN ONLINE, 24/7



## KEYSTONE DECORATOR STYLE ROTATING HDMI FACEPLATE INSERT

<b>Keystone Faceplates</b>	<b>NON-PLENUM</b>	<b>WJ-DECHD1</b>
<b>Features &amp; Benefits:</b>		<b>Application:</b>
<ul style="list-style-type: none"> <li>· Decorator insert with one 360 degree rotating 90 degree HDMI port</li> <li>· White</li> <li>· UL listed communication circuit accessory</li> </ul>		<ul style="list-style-type: none"> <li>· Decorator format wall plate</li> <li>· Convenience outlet management for structured solutions</li> <li>· HDMI signal routing and distribution</li> </ul>
AVAILABLE COLORS: <input type="checkbox"/> WHITE		



## KEYSTONE DECORATOR STYLE ROTATING HDMI W/2 PORTS FACEPLATE INSERT

<b>Keystone Faceplates</b>	<b>NON-PLENUM</b>	<b>WJ-DECHD2KJ</b>
<b>Features &amp; Benefits:</b>		<b>Application:</b>
<ul style="list-style-type: none"> <li>· Decorator insert with one 360 degree rotating 90 degree HDMI port</li> <li>· Two extra keystone empty ports for other inserts</li> <li>· White</li> <li>· UL listed communication circuit accessory</li> </ul>		<ul style="list-style-type: none"> <li>· Decorator format wall plate</li> <li>· Convenience outlet management for structured solutions</li> <li>· HDMI signal routing and distribution</li> </ul>
AVAILABLE COLORS: <input type="checkbox"/> WHITE		

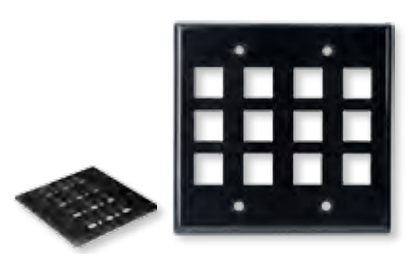

## KEYSTONE DOUBLE GANG 12-PORT SMOOTH FACEPLATE

<b>Keystone Faceplates</b>	<b>NON-PLENUM</b>	<b>WP-N12</b>
<b>Features &amp; Benefits:</b>		<b>Application:</b>
<ul style="list-style-type: none"> <li>· Double Gang 12-port smooth face</li> <li>· Keystone compatible</li> <li>· White, Almond, Black and Ivory</li> <li>· UL listed communication circuit accessory</li> </ul>		<ul style="list-style-type: none"> <li>· Convenience outlet management for structured solutions</li> <li>· Keystone inserts for audio, video, LAN, speaker, and phone</li> </ul>
AVAILABLE COLORS: <input type="checkbox"/> WHITE <input type="checkbox"/> ALMOND <input type="checkbox"/> IVORY <input type="checkbox"/> BLACK		



## KEYSTONE SINGLE GANG 1-PORT SMOOTH FACEPLATE

<b>Keystone Faceplates</b>	<b>NON-PLENUM</b>	<b>WP-N1</b>
<b>Features &amp; Benefits:</b>		<b>Application:</b>
<ul style="list-style-type: none"> <li>· Single Gang 1-port smooth face</li> <li>· Keystone compatible</li> <li>· White, Almond, Black and Ivory</li> <li>· UL listed communication circuit accessory</li> </ul>		<ul style="list-style-type: none"> <li>· Convenience outlet management for structured solutions</li> <li>· Keystone inserts for audio, video, LAN, speaker, and phone</li> </ul>
AVAILABLE COLORS: <input type="checkbox"/> WHITE <input type="checkbox"/> ALMOND <input type="checkbox"/> IVORY <input type="checkbox"/> BLACK		



## KEYSTONE SINGLE GANG 2-PORT SMOOTH FACEPLATE

<b>Keystone Faceplates</b>	<b>NON-PLENUM</b>	<b>WP-N2</b>
<b>Features &amp; Benefits:</b>		<b>Application:</b>
<ul style="list-style-type: none"> <li>· Single Gang 2-port smooth face</li> <li>· Keystone compatible</li> <li>· White, Almond, Black and Ivory</li> <li>· UL listed communication circuit accessory</li> </ul>		<ul style="list-style-type: none"> <li>· Convenience outlet management for structured solutions</li> <li>· Keystone inserts for audio, video, LAN, speaker, and phone</li> </ul>
AVAILABLE COLORS: <input type="checkbox"/> WHITE <input type="checkbox"/> ALMOND <input type="checkbox"/> IVORY <input type="checkbox"/> BLACK		



## KEYSTONE SINGLE GANG 3-PORT SMOOTH FACEPLATE

<b>Keystone Faceplates</b>	<b>NON-PLENUM</b>	<b>WP-N3</b>
<b>Features &amp; Benefits:</b>		<b>Application:</b>
<ul style="list-style-type: none"> <li>· Single Gang 3-port smooth face</li> <li>· Keystone compatible</li> <li>· White, Almond, Black and Ivory</li> <li>· UL listed communication circuit accessory</li> </ul>		<ul style="list-style-type: none"> <li>· Convenience outlet management for structured solutions</li> <li>· Keystone inserts for audio, video, LAN, speaker, and phone</li> </ul>
AVAILABLE COLORS: <input type="checkbox"/> WHITE <input type="checkbox"/> ALMOND <input type="checkbox"/> IVORY <input type="checkbox"/> BLACK		

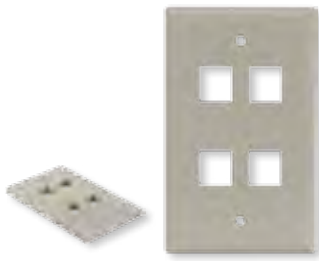

## KEYSTONE SINGLE GANG 4-PORT SMOOTH FACEPLATE

**Keystone Faceplates**

**NON-PLENUM**

**WP-N4**

**Features & Benefits:**

- Single Gang 4-port smooth face
- Keystone compatible
- White, Almond, Black and Ivory
- UL listed communication circuit accessory

**Application:**

- Convenience outlet management for structured solutions
- Keystone inserts for audio, video, LAN, speaker, and phone

AVAILABLE COLORS:



## KEYSTONE SINGLE GANG 6-PORT SMOOTH FACEPLATE

**Keystone Faceplates**

**NON-PLENUM**

**WP-N6**

**Features & Benefits:**

- Single Gang 6-port smooth face
- Keystone compatible
- White, almond, black and ivory
- UL listed communication circuit accessory

**Application:**

- Convenience outlet management for structured solutions
- Keystone inserts for audio, video, LAN, speaker, and phone

AVAILABLE COLORS:



## KEYSTONE COMPATIBLE 3.5 JACK TRS INSERTS

**Keystone Inserts**

**NON-PLENUM**

**ISK-35S**

**Features & Benefits:**

- 3.5mm Tip-Ring-Sleeve female to spring loaded terminal block connectivity
- Keystone compatible
- White, and Ivory only
- UL listed communication circuit accessory

**Application:**

- Line level unbalanced stereo audio
- Line or Mic level balanced mono audio
- RS-232C, InfraRed
- Structured convenience outlet for audio distribution

AVAILABLE COLORS:



## KEYSTONE COMPATIBLE BNC PASS THROUGH INSERTS

**Keystone Inserts**

**NON-PLENUM**

**ISK-BNC**

**Features & Benefits:**

- BNC female coupler for Video
- Keystone compatible
- Almond, White, and Ivory
- UL listed communication circuit accessory

**Application:**

- Analog video routing and interconnection
- Security video routing and connectivity
- Structured convenience outlet for video

AVAILABLE COLORS:



## KEYSTONE COMPATIBLE F CONNECTOR PASS THROUGH INSERTS

**Keystone Inserts**

**NON-PLENUM**

**ISK-F**

**Features & Benefits:**

- HDMI signal routing and interconnection
- Compatible with DVI-D Single Link
- Structured convenience outlet for HDMI Distribution

**Application:**

- CATV and DBS Video routing and interconnection
- Security Video routing and connectivity
- Structured convenience outlet for CATV/DBS

AVAILABLE COLORS:



## KEYSTONE COMPATIBLE HDMI® CONNECTOR PASS THROUGH INSERTS

**Keystone Inserts**

**NON-PLENUM**

**ISKM-HD**

**Features & Benefits:**

- HDMI female coupler for digital multimedia
- Keystone compatible
- Passive format, equalization may be required after coupling
- Only available in white
- UL listed communication circuit accessory

**Application:**

- HDMI signal routing and interconnection
- Compatible with DVI-D Single Link
- Structured convenience outlet for HDMI distribution

AVAILABLE COLORS:







## KEYSTONE COMPATIBLE MULTIMODE SC CONNECTOR PASS THROUGH INSERTS

Keystone Inserts	NON-PLENUM	ISK-SC
<b>Features &amp; Benefits:</b> <ul style="list-style-type: none"> <li>· SC female coupler for Multimode Fiber Optic cables</li> <li>· Keystone compatible</li> <li>· Only available in white</li> <li>· UL listed communication circuit accessory</li> </ul>		<b>Application:</b> <ul style="list-style-type: none"> <li>· Fiber signal routing and interconnection</li> <li>· Compatible with OM1, OM2, OM3, and OM4 connectors</li> <li>· Structured convenience outlet for Fiber Distribution</li> </ul>
AVAILABLE COLORS:	<input type="checkbox"/>	
	WHITE	



## KEYSTONE COMPATIBLE RCA CONNECTOR PASS THROUGH INSERTS

Keystone Inserts	NON-PLENUM	ISKF-RCAF
<b>Features &amp; Benefits:</b> <ul style="list-style-type: none"> <li>· RCA female coupler for Audio and Video</li> <li>· Keystone compatible</li> <li>· Almond, White, and Ivory</li> <li>· UL listed communication circuit accessory</li> </ul>		<b>Application:</b> <ul style="list-style-type: none"> <li>· Line level unbalanced audio</li> <li>· Analog video, composite, Y/C or component video</li> <li>· S/PDIF digital audio</li> <li>· Structured convenience outlet for audio/video distribution</li> </ul>
AVAILABLE COLORS:	<input type="checkbox"/>	<input type="checkbox"/>
	WHITE	ALMOND
		IVORY



## KEYSTONE COMPATIBLE SPEAKER BANANA INSERTS

Keystone Inserts	NON-PLENUM	ISK-BJ
<b>Features &amp; Benefits:</b> <ul style="list-style-type: none"> <li>· 5-Way Binding Post for Speakers</li> <li>· Keystone compatible</li> <li>· Almond, White, and Ivory with Red and Black channels</li> <li>· UL listed communication circuit accessory</li> </ul>		<b>Application:</b> <ul style="list-style-type: none"> <li>· Speaker level amplified audio interconnection</li> <li>· Home theater speaker routing and connectivity</li> <li>· Structured convenience outlet speaker systems</li> </ul>
AVAILABLE COLORS:	<input type="checkbox"/>	<input type="checkbox"/>
	WHITE	ALMOND
		IVORY



## KEYSTONE COMPATIBLE BLANK INSERTS

Keystone Inserts	NON-PLENUM	ISK
<b>Features &amp; Benefits:</b> <ul style="list-style-type: none"> <li>· Blank Port snap in cover</li> <li>· Almond, White, and Ivory</li> <li>· UL listed communication circuit accessory</li> </ul>		<b>Application:</b> <ul style="list-style-type: none"> <li>· Covering open unused ports in Keystone format plates and panels</li> <li>· Structured convenience outlet port management</li> </ul>
AVAILABLE COLORS:	<input type="checkbox"/>	<input type="checkbox"/>
	WHITE	ALMOND
		IVORY



## KEYSTONE COMPATIBLE CATEGORY 3 U/UTP 90 DEGREE PUNCH DOWN INSERTS

Keystone Inserts	NON-PLENUM	KX-6
<b>Features &amp; Benefits:</b> <ul style="list-style-type: none"> <li>· Category 3 Certified RJ45 Jack (Female)</li> <li>· Will not fit 4 and 6 port Decor style plates side by side</li> <li>· Universal IDC 100 / Krone Punchdown 90 degree format</li> <li>· Compatible with Leviton plates and panels</li> <li>· UL listed communication circuit accessory</li> </ul>		<b>Application:</b> <ul style="list-style-type: none"> <li>· Phone, voice over IP, audio, InfraRed</li> <li>· Structured convenience outlet for phone and voice</li> </ul>
AVAILABLE COLORS:	<input type="checkbox"/>	<input type="checkbox"/>
	WHITE	ALMOND
		IVORY



# WebBlox<sup>®</sup>

## CUSTOM PLATE DESIGN



www.LibAV.com

- ADD YOUR OWN LOGO
- FREE SERVICE, PASSWORD PROTECT YOUR DESIGNS
- DESIGN ONLINE, 24/7



## KEYSTONE COMPATIBLE CATEGORY 5E U/UTP 90 DEGREE PUNCH DOWN INSERTS

Keystone Inserts	NON-PLENUM	K5-8PE																		
<b>Features &amp; Benefits:</b> <ul style="list-style-type: none"> <li>Category 5e Certified RJ45 Jack (Female)</li> <li>Will not fit 4 and 6 port Decor style plates side by side</li> <li>Universal IDC 100 / Krone Punchdown 90 degree format</li> <li>Compatible with Leviton plates and panels</li> <li>Black, Gray, White, Yellow, Orange, Green, Blue, Red</li> <li>UL listed communication circuit accessory</li> </ul>		<b>Application:</b> <ul style="list-style-type: none"> <li>Convenience outlets for LAN 10/100/1000BaseT ethernet</li> <li>Phone, voice over IP, audio, InfraRed, IP control</li> <li>Security, internet</li> <li>Structured convenience outlet for LAN</li> </ul>																		
AVAILABLE COLORS: <table style="display: inline-table; border: none;"> <tr> <td style="width: 20px; height: 10px; background-color: white; border: 1px solid black;"></td> <td style="width: 20px; height: 10px; background-color: #f0e68c; border: 1px solid black;"></td> <td style="width: 20px; height: 10px; background-color: #fff2cc; border: 1px solid black;"></td> <td style="width: 20px; height: 10px; background-color: black; border: 1px solid black;"></td> <td style="width: 20px; height: 10px; background-color: blue; border: 1px solid black;"></td> <td style="width: 20px; height: 10px; background-color: green; border: 1px solid black;"></td> <td style="width: 20px; height: 10px; background-color: grey; border: 1px solid black;"></td> <td style="width: 20px; height: 10px; background-color: red; border: 1px solid black;"></td> <td style="width: 20px; height: 10px; background-color: yellow; border: 1px solid black;"></td> </tr> <tr> <td style="text-align: center; font-size: 8px;">WHITE</td> <td style="text-align: center; font-size: 8px;">ALMOND</td> <td style="text-align: center; font-size: 8px;">IVORY</td> <td style="text-align: center; font-size: 8px;">BLACK</td> <td style="text-align: center; font-size: 8px;">BLUE</td> <td style="text-align: center; font-size: 8px;">GREEN</td> <td style="text-align: center; font-size: 8px;">GREY</td> <td style="text-align: center; font-size: 8px;">RED</td> <td style="text-align: center; font-size: 8px;">YELLOW</td> </tr> </table>												WHITE	ALMOND	IVORY	BLACK	BLUE	GREEN	GREY	RED	YELLOW
WHITE	ALMOND	IVORY	BLACK	BLUE	GREEN	GREY	RED	YELLOW												



## KEYSTONE COMPATIBLE CATEGORY 6 F/UTP 90 DEGREE PUNCH DOWN INSERTS

Keystone Inserts	NON-PLENUM	K6-8KPS		
<b>Features &amp; Benefits:</b> <ul style="list-style-type: none"> <li>Category 6 Certified Shielded RJ45 Jack (Female)</li> <li>Will fit 4 and 6 port Decor style plates side by side</li> <li>Universal IDC 100 / Krone Punchdown 90 degree format</li> <li>Compatible with Leviton plates and panels</li> <li>UL listed communication circuit accessory</li> </ul>		<b>Application:</b> <ul style="list-style-type: none"> <li>Convenience outlets for LAN 10/100/1000BaseT ethernet</li> <li>Phone, voice over IP, audio, InfraRed, IP control</li> <li>Security, internet</li> <li>Structured convenience outlet for LAN</li> </ul>		
AVAILABLE COLORS: <table style="display: inline-table; border: none;"> <tr> <td style="width: 20px; height: 10px; background-color: grey; border: 1px solid black;"></td> </tr> <tr> <td style="text-align: center; font-size: 8px;">METAL</td> </tr> </table>				METAL
METAL				



## KEYSTONE COMPATIBLE CATEGORY 6 U/UTP 90 DEGREE PUNCH DOWN INSERTS

Keystone Inserts	NON-PLENUM	K6-8KP										
<b>Features &amp; Benefits:</b> <ul style="list-style-type: none"> <li>Category 6 Certified RJ45 Jack (Female)</li> <li>Will fit 4 and 6 port Decor style plates side by side</li> <li>Universal IDC 100 / Krone Punchdown 90 degree format</li> <li>Compatible with Leviton plates and panels</li> <li>Black, Gray, White, Yellow, Orange, Green, Blue, Red</li> <li>UL listed communication circuit accessory</li> </ul>		<b>Application:</b> <ul style="list-style-type: none"> <li>Convenience outlets for LAN 10/100/1000BaseT ethernet</li> <li>Phone, voice over IP, audio, InfraRed, IP control</li> <li>Security, internet</li> <li>Structured convenience outlet for LAN</li> </ul>										
AVAILABLE COLORS: <table style="display: inline-table; border: none;"> <tr> <td style="width: 20px; height: 10px; background-color: black; border: 1px solid black;"></td> <td style="width: 20px; height: 10px; background-color: blue; border: 1px solid black;"></td> <td style="width: 20px; height: 10px; background-color: grey; border: 1px solid black;"></td> <td style="width: 20px; height: 10px; background-color: #fff2cc; border: 1px solid black;"></td> <td style="width: 20px; height: 10px; background-color: white; border: 1px solid black;"></td> </tr> <tr> <td style="text-align: center; font-size: 8px;">BLACK</td> <td style="text-align: center; font-size: 8px;">BLUE</td> <td style="text-align: center; font-size: 8px;">GREY</td> <td style="text-align: center; font-size: 8px;">IVORY</td> <td style="text-align: center; font-size: 8px;">WHITE</td> </tr> </table>								BLACK	BLUE	GREY	IVORY	WHITE
BLACK	BLUE	GREY	IVORY	WHITE								



## KEYSTONE STYLE RJ45 IN-LINE COUPLER FOR CATEGORY 5E F/UTP LAN

Keystone Inserts	NON-PLENUM	CP-8S
<b>Features &amp; Benefits:</b> <ul style="list-style-type: none"> <li>Keystone Insert Format, High Density for Decor style</li> <li>Category 5e RJ45 Coupler Jack (Female)</li> <li>Pass Through format</li> <li>Fully shielded for F/UTP and STP Cable formats</li> <li>Compatible with Leviton plates and panels</li> </ul>		<b>Application:</b> <ul style="list-style-type: none"> <li>Convenience outlets for LAN 10/100/1000BaseT ethernet</li> <li>Phone, voice over IP, audio, InfraRed, IP control</li> <li>Security, internet</li> </ul>



## KEYSTONE STYLE RJ45 IN-LINE COUPLER FOR CATEGORY 5E U/UTP LAN

Keystone Inserts	NON-PLENUM	CP-8						
<b>Features &amp; Benefits:</b> <ul style="list-style-type: none"> <li>Keystone Insert Format, High Density for Decor style</li> <li>Category 5e RJ45 Coupler Jack (Female)</li> <li>Pass Through format</li> <li>Compatible with Leviton plates and panels</li> <li>Available in white and ivory only</li> </ul>		<b>Application:</b> <ul style="list-style-type: none"> <li>Convenience outlets for LAN 10/100/1000BaseT ethernet</li> <li>Phone, voice over IP, audio, InfraRed, IP control</li> <li>Security, internet</li> </ul>						
AVAILABLE COLORS: <table style="display: inline-table; border: none;"> <tr> <td style="width: 20px; height: 10px; background-color: white; border: 1px solid black;"></td> <td style="width: 20px; height: 10px; background-color: #f0e68c; border: 1px solid black;"></td> <td style="width: 20px; height: 10px; background-color: #fff2cc; border: 1px solid black;"></td> </tr> <tr> <td style="text-align: center; font-size: 8px;">WHITE</td> <td style="text-align: center; font-size: 8px;">ALMOND</td> <td style="text-align: center; font-size: 8px;">IVORY</td> </tr> </table>						WHITE	ALMOND	IVORY
WHITE	ALMOND	IVORY						



## KEYSTONE STYLE RJ45 IN-LINE COUPLER FOR CATEGORY 6 U/UTP LAN

### Keystone Inserts

NON-PLENUM

CP-8B

#### Features & Benefits:

- Keystone Insert Format, High Density for Decor style
- Category 6 RJ45 Coupler Jack (Female)
- Pass Through format
- Compatible with Leviton plates and panels
- Available in white and ivory only

AVAILABLE COLORS:

WHITE

ALMOND

IVORY

#### Application:

- Convenience Outlets for LAN 10/100/1000BaseT Ethernet
- Phone, Voice over IP, Audio, InfraRed, IP Control
- Security, Internet



## ECONOMY STRUCTURED SOLUTION BULK WIRE PLATE W/REVERSIBLE NOSE IN DOUBLE GANG FORMAT

### Bulk Cable Passthrough Faceplates

#### Features & Benefits:

- \* Double Gang Faceplate
- \* Reversible Nose Plate for External or Internal feeds
- \* Patented design
- \* UL listed
- \* White is stocked

AVAILABLE COLORS:

WHITE

UWGD0000

#### Application:

- \* Cable feed out of walls, eliminates passive junctions
- \* Very low profile TV and Display cabling



## ECONOMY STRUCTURED SOLUTION BULK WIRE PLATE W/ REVERSIBLE NOSE IN SINGLE GANG FORMAT

### Bulk Cable Passthrough Faceplates

#### Features & Benefits:

- Single Gang Faceplate
- Reversible Nose Plate for External or Internal feeds
- Patented design
- UL listed
- White is stocked

AVAILABLE COLORS:

WHITE

ALMOND

IVORY

UWGS0000

#### Application:

- Cable feed out of walls, eliminates passive junctions
- Very low profile TV and Display cabling



## ARLINGTON INDUSTRIES RETROFIT STYLE LOW VOLTAGE SINGLE GANG MOUNTING BRACKET

### MOUNTING - BRACKET

#### Features & Benefits:

- Single gang size with tabs for existing construction
- Low-voltage and Communications equipment only
- Sold in boxes of 10 each
- UL listed

LV1

#### Application:

- Installation of low voltage and communications accessories
- Convenience outlet installation and routing



## ARLINGTON INDUSTRIES RETROFIT STYLE LOW VOLTAGE DOUBLE GANG MOUNTING BRACKET

### MOUNTING - BRACKET

#### Features & Benefits:

- Double gang size with tabs for existing construction
- Low-voltage and Communications equipment only
- Sold in boxes of 10 each
- UL listed

LV2

#### Application:

- Installation of low voltage and communications accessories
- Convenience outlet installation and routing



**BARGAIN BIN!**  
**PRICES DROP DAILY**  
Check back daily for lower prices on overstock items!  
[www.LibAV.com](http://www.LibAV.com)



## ARLINGTON INDUSTRIES RETROFIT STYLE LOW VOLTAGE TRIPLE GANG MOUNTING BRACKET

### MOUNTING - BRACKET

#### Features & Benefits:

- 3 gang size with tabs for existing construction
- Low-voltage and communications equipment only
- Sold in boxes of 10 each
- UL listed

### LV3

#### Application:

- Installation of low voltage and communications accessories
- Convenience outlet installation and routing



**INSTALLER'S CHOICE  
SNAPRAX SERIES**  
See Page: 258



## ARLINGTON INDUSTRIES NEW CONSTRUCTION STYLE LOW VOLTAGE SINGLE GANG MOUNTING BRACKET

### MOUNTING - BRACKET

#### Features & Benefits:

- Single gang size for new construction
- Low-voltage and communications equipment only
- Compatible with 3/4 inch EMT conduit
- Sold in boxes of 10 each
- UL listed

### LVMB1

#### Application:

- Installation of low voltage and communications accessories
- Convenience outlet installation and routing



## ARLINGTON INDUSTRIES NEW CONSTRUCTION STYLE LOW VOLTAGE DOUBLE GANG MOUNTING BRACKET

### MOUNTING - BRACKET

#### Features & Benefits:

- Double gang size for new construction
- Low-voltage and communications equipment only
- Compatible with 3/4 inch EMT conduit
- Sold in boxes of 10 each
- UL listed

### LVMB2

#### Application:

- Installation of low voltage and communications accessories
- Convenience outlet installation and routing



**New Website**  
[www.LibAV.com](http://www.LibAV.com)  
**BETTER, STRONGER,  
EXPANSIVE!**



## ECONOMY DOUBLE GANG FLUSH MOUNT METAL MUD RINGS

### MOUNTING - FLUSH

#### Features & Benefits:

- Double gang size metal mud ring
- Low-voltage and communications equipment only
- Flush mount
- Sold in boxes of 10 each
- UL listed communication circuit accessory

### MB-DM

#### Application:

- Installation of low voltage and communications accessories
- Convenience outlet installation and routing

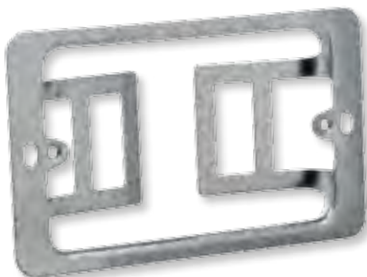

## ECONOMY SINGLE GANG FLUSH MOUNT METAL MUD RINGS

### MOUNTING - FLUSH

#### Features & Benefits:

- Single gang size metal mud ring
- Low-voltage and communications equipment only
- Flush mount
- Sold in boxes of 10 each
- UL listed communication circuit accessory

### MB-SM

#### Application:

- Installation of low voltage and communications accessories
- Convenience outlet installation and routing



**LIBERTY**  
**AV SOLUTIONS**  
Distributed Product ★★★

# POWER PROTECTION

**RUN WITH US**

## SMARTPRO .5KVA LINE INTERACTIVE UPS

Power Back-up NON-PLENUM

SMART500RT1U



### Features & Benefits:

- 500VA line interactive 1U rack/tower UPS
- 120V nominal output during brownouts as low as 90V
- USB, RS232, EPO and optional SNMP/Web card are available for simultaneous use
- Front panel status LEDs; 1 switched output load bank
- 2 independently switchable output load banks
- NEMA 5-15P input; 7 NEMA 5-15R outlets

### Application:

- Rack Power back up and voltage regulation
- Filters brown outs and voltage spikes
- Excellent for poor power areas to protect A/V and IT equipment

### Overview:

Tripp Lite's SMART500RT1U intelligent, line interactive rack/tower uninterruptible power supply prevents data loss, downtime and equipment damage due to power outages, voltage fluctuations and transient surges. Requires only one rack space (1U) in a 2 or 4 post rack, with included accessories for upright tower placement. Large internal batteries offer 8 minutes half load runtime and 3 minutes at full load. Maintains regulated 120V nominal output without using battery power during brownouts as low as 90V. 500VA/300 watt power handling capability is compatible with networking, telecom and other sensitive electronic applications.

## SMARTPRO 1.5KVA 1.35KW LINE INTERACTIVE EXTENDED RUN UPS

Power Back-up NON-PLENUM

SMART1500RMXL2UA



### Features & Benefits:

- 1.5kVA / 1500VA / 1350 watt line interactive 2U rack / tower UPS, 0.9 power factor
- 120V nominal output during brownouts to 83V and overvoltages to 145V
- Interactive LCD UPS status information and advanced configuration options
- Expandable runtime, Hot-swap batteries, 95% efficiency, Sine wave output
- 2 independently switchable output load banks
- NEMA 5-15P input, 8 NEMA 5-15R outlets

### Application:

- Rack Power back up and voltage regulation
- Filters brown outs and voltage spikes
- Excellent for poor power areas to protect A/V and IT equipment

### Overview:

Tripp Lite SmartPro Line Interactive UPS with enhanced LCD interface offers network-grade power protection for critical server, network and telecommunications equipment. Line Interactive Uninterruptible Power Supply (UPS) with built-in Auto-Voltage Regulation (AVR) actively corrects brownouts and overvoltages back to usable levels while maintaining a full battery charge in case of power failure. Tripp Lite's unique configuration excels in exceptionally poor-power environments with two separate levels of voltage boost to correct both slight undervoltages and severe brownout conditions. Interactive LCD interface reports UPS operating mode, detailed UPS and site-power data, plus enables a variety of UPS setup and configuration options.

## WABER-BY-TRIPP LITE 6SPDX POWER STRIP

Power Distribution

6SPDX



### Features & Benefits:

- 6 NEMA 5-15R Receptacles
- 6 Foot Power Cord
- All Metal Housing
- Lighted power switch and resettable circuit breaker
- Pass through power without filtering.

### Application:

- Power distribution
- Expansion of current available outlets

### Overview:

The Waber-by-Tripp Lite 6SPDX Power Strip offers a convenient method of power distribution in workbench, wallmount or floor mount applications. Includes 6 NEMA 5-15R output receptacles with 1.520-in. center-to-center spacing, 6-foot AC line cord and keyhole mounting tabs for installation in a wide variety of applications. Corded, multi-outlet strip reduces cabling clutter and enables the connection of multiple electrical devices to a single AC wall socket.

## WABER-BY-TRIPP LITE POWER STRIP W/ 6 OUTLETS AND 15-FT. CORD

UL620-15

### Power Distribution



**GET THE EDGE!**  
CoolSpool System®  
means tangle-free  
pulls and easy  
transportation

### Features & Benefits:

- 6 outlets accept NEMA5-15P or 5-20P input plugs
- 20-amp circuit breaker
- All metal housing
- 12.5" length
- 15 ft. cord

### Application:

- Power Distribution Power Strip
- Convenient workbench, wall mount, or floor mount power source
- Ideal for alternate waveform power format distribution

### Overview:

The Waber-by-Tripp Lite UL620-15 Power Strip offers a convenient method of power distribution in workbench, wallmount or floor mount applications. Includes 6 NEMA 5-15R/20R output receptacles with 1.625 inch center-to-center spacing, 15 foot AC line cord and keyhole mounting tabs for installation in a wide variety of applications. Corded, multi-outlet strip reduces cabling clutter and enables the connection of multiple electrical devices to a single AC wall socket. Unfiltered electrical pass-through makes UL620-15 ideal for distributing alternate waveform UPS or generator power.

## 6-OUTLET ULTIMATE PROTECTION ISOBAR AUDIO/VIDEO SURGE SUPPRESSOR

AVBAR6

### Power Protection



**New Website**  
[www.LibAV.com](http://www.LibAV.com)  
**BETTER, STRONGER,  
EXPANSIVE!**

### Features & Benefits:

- 6 Port Power Conditioning Power Strip
- 3330 joules surge suppression
- Isolated Filter Banks
- 2 line in 2.2 GHz coax protection.
- 1 line in telephone protection
- 1 line in LAN network protection

### Application:

- Home Structured Solution A/V Power Conditioning
- CATV / Telephone / LAN and Internet protection

### Overview:

Tripp Lite's AVBAR6 Platinum Series Isobar Audio Video Surge/Spike Suppressor provides premium protection (3330 joules) stopping damaging surges and filtering disruptive EMI/RFI line noise so components perform at their peak! You can see and hear the difference: sharper, crisper video; deeper, fuller audio and longer component life spans. Perfect for small-to-medium Audio/Video installations: high-definition video displays, HD Cable / HD satellite sources and A/V receivers, DVD/CD players and more. Exclusive Isolated Filter Banks eliminate noise interference between components. 6 outlets (widely spaced outlets accommodate up to 2 transformers and plug-in safety covers), 2-line HD 2.2 GHz coaxial protection and 1-line tel/modem protection safeguard an entire A/V system.

## PROFESSIONAL AUDIO/VIDEO ISOBAR POWER CONDITIONING CENTER

AV3500PC

### Power Protection



### Features & Benefits:

- 8-Outlet Professional A/V Power Conditioning Center
- Isobar® Technology.
- Two EMI/RFI filtering banks.
- Input voltage LCD (dimnable) meter w/ diagnostic LEDs.
- 5700 joules surge/spike protection
- 3-line 2.2 GHz coax 1-line tel w/splitter surge Protection
- Full equipment depth for install/maintenance ease
- 1U Rackmount ears. 10' cord with right-angle plug
- Unit: 1.75" x 17.5" x 14.75" (HxWxD)

### Application:

- Surge Protection for A/V systems input
- A/V equipment rack surge protection

### Overview:

Tripp Lite's AVBAR6 Platinum Series Isobar Audio Video Surge/Spike Suppressor provides premium protection (3330 joules) stopping damaging surges and filtering disruptive EMI/RFI line noise so components perform at their peak! You can see and hear the difference: sharper, crisper video; deeper, fuller audio and longer component life spans. Perfect for small-to-medium Audio/Video installations: high-definition video displays, HD Cable / HD satellite sources and A/V receivers, DVD/CD players and more. Exclusive Isolated Filter Banks eliminate noise interference between components. 6 outlets (widely spaced outlets accommodate up to 2 transformers and plug-in safety covers), 2-line HD 2.2 GHz coaxial protection and 1-line tel/modem protection safeguard an entire A/V system.



## PROFESSIONAL ISOBAR LOW-PROFILE POWER CONDITIONING CENTER FOR FLAT SCREEN DISPLAYS **AV2FP**

Power Protection **NON-PLENUM**



### TECH SPECS

Up-to-date and complete tech specs for all products available at [www.LibAV.com](http://www.LibAV.com)



### Features & Benefits:

- 5100 joules surge suppression
- EMI/RFI RJ45 protection for streaming video displays.
- 2.2 GHz coax protection.
- low-profile, metal housing mounts behind any flat-panel.
- LEDs (Surge Protection On, Ground wiring OK, Line OK).
- Ships with choice of 2 EIC detachable cords (18", 10')

### Application:

- Surge Protection for Flat Screens
- Audio/Video Display protection

### Overview:

Tripp Lite's AV2FP Professional Isobar Low-Profile Power Conditioning Center for flat screen displays provides ultimate protection (5100 joules) stopping damaging surges/spikes. Filters disruptive EMI/RFI line noise so Digital Displays perform to their full capability! You can see and hear the difference: sharper, crisper deeper, video; helps maintain longer component life spans. High Definition bi-directional 2.2 GHz (gold) coaxial protects against surges /spikes from coming in on the coax input. Network/Ethernet protection with RJ45 covers all 8 pins for matrix switchers and streaming internet content. 3 diagnostic LEDs report conditions, 2 AC outlets, includes detachable 10-ft. and 18-in. power cords with right-angle plugs, circuit breaker, fail-safe thermal fusing and audible alarm.

## TRIPPLITE INTELLIGENT AUTOMATIC VOLTAGE REGULATED POWER MANAGEMENT SYSTEM

**HTR05-1U**

Surge Suppression



### Features & Benefits:

- \* 500VA - 300Watt Automatic Voltage Regulated 1U UPS System
- \* 7 outlets; 1 switchable load
- \* IP remote access, control and diagnostics capability with email notification
- \* Simultaneous communications via SNMPWEBCARD slot, USB and DB9 serial ports
- \* Drivers written for Crestron, AMX and Savant for seamless integration

### Application:

- \* Rack Power Management for A/V applications
- \* Surge Suppression
- \* Power Integration into A/V control systems

### Overview:

Tripp Lite's AVBAR6 Platinum Series Isobar Audio Video Surge/Spike Suppressor provides premium protection (3330 joules) stopping damaging surges and filtering disruptive EMI/RFI line noise so components perform at their peak! You can see and hear the difference: sharper, crisper video; deeper, fuller audio and longer component life spans. Perfect for small-to-medium Audio/Video installations: high-definition video displays, HD Cable / HD satellite sources and A/V receivers, DVD/CD players and more. Exclusive Isolated Filter Banks eliminate noise interference between components. 6 outlets (widely spaced outlets accommodate up to 2 transformers and plug-in safety covers), 2-line HD 2.2 GHz coaxial protection and 1-line tel/modem protection safeguard an entire A/V system.

# HDMI ADAPTER RING

Keep your adapters where they need to be & immediately accessible for your mobile content presentation podium, boardroom, or docking station!

**DL-AR**

### PERFECT FOR:

- Adapting various mobile content devices to HDMI
- Interfacing Laptops, Macs, iPad, Smartphone to HDMI

SEE PAGE 132



**DIGITALINX™**





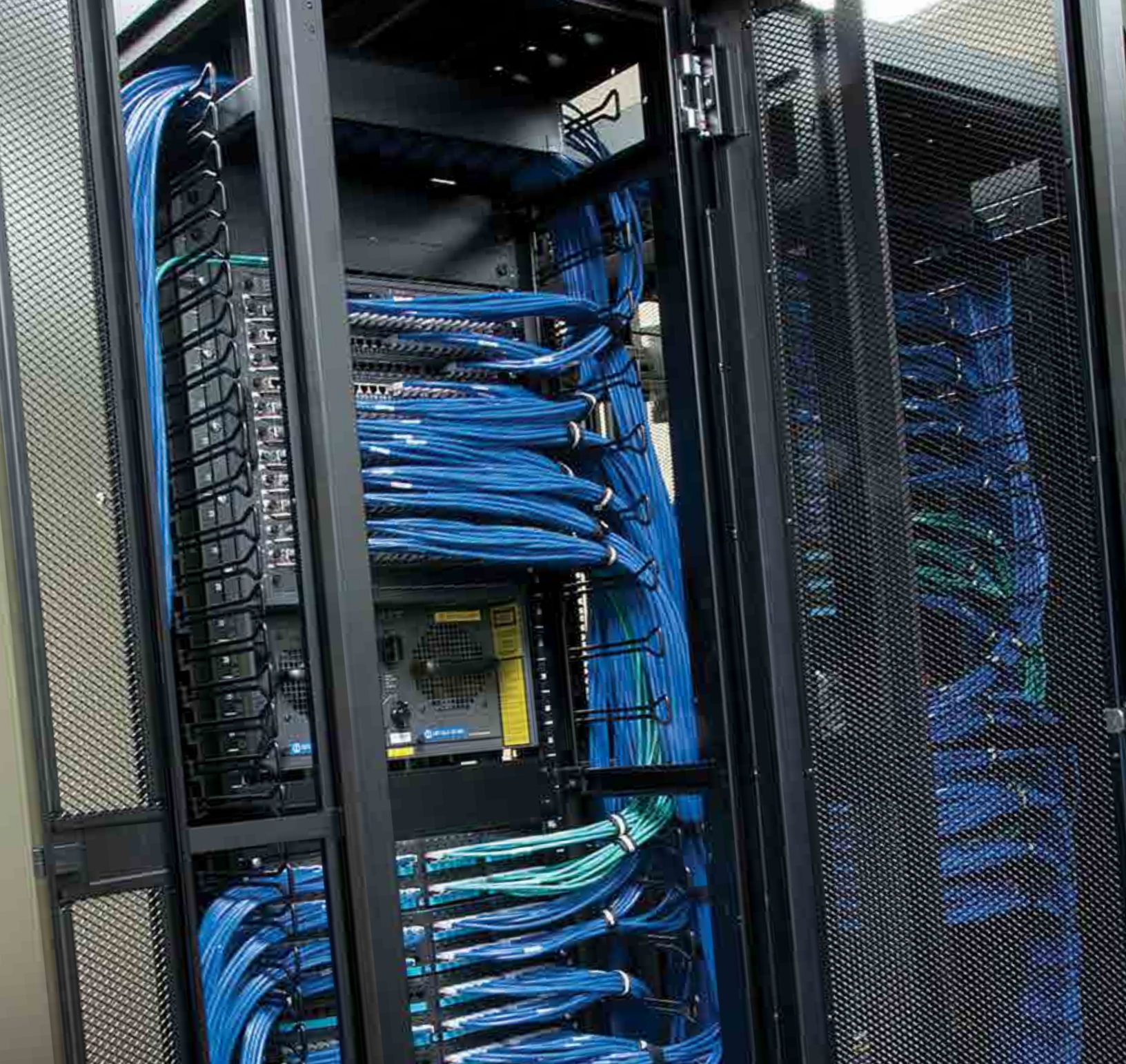

**LIBERTY**  
**AV SOLUTIONS**  
Distributed Product ★★★

# **RACKS & ACCESSORIES**

**RUN WITH US**



# SNAPRAX RACK SERIES

Designed to provide safe and secure mounting for all AV equipment and assembles in 3 minutes or less!

ASSEMBLE IN **3** MINUTES!



WATCH IT NOW!  
HD TERMINATION



- Assembles on-site in 3 minutes or less
- Ships in individual boxes to maneuver through small spaces, tight hallways and narrow stairwells



**ALL SNAPRAX FRAMES INCLUDE:**

- Self-squaring top and base sections
- Four main rails
- Center channels
- Caster base and casters
- Cable egress with grommets
- Leveler brake
- Mounting hardware



**FIBER OPTIC ENCLOSURES**  
PAGE 210

## SNAPRAX

“ SnapRax frames are knockdown AV racks and can be assembled in fewer than 3 minutes with 8 screws total. It was designed to provide safe and secure mounting for all AV equipment while saving the installer valuable time at every job site. It has a 20” overall frame width and is available in depths of 20” and 26”, with RU heights of 8, 14, 21, 29, 37 and 43. The 26” depth SnapRax frames also include 1 pr. adjustable rear-mount split rails. Options include side, rear and blanking panels, as well as an extensive variety of doors, shelves and cooling accessories. Pre-configured kits that have drawers and shelves are also available. ”



### INSTALLERS CHOICE SNAPRAX QUICK ASSEMBLY NON-WELDED RACK 14RUX20D

#### SR14

##### Features & Benefits:

- Installers Choice quick assembly SnapRax format
- User assembled in less than 15 minutes typical
- 14RU high and 20 inches deep
- Sturdy, UL listed, and convenient
- Includes base, top, main channels and side struts

##### Application:

- Installation of head end where lead times are not acceptable
- Head end A/V and IT installs



**WebBlox**  
CUSTOMIZE YOUR PLATES  
WITH PANELCRAFTERS  
[www.LibAV.com](http://www.LibAV.com)

### INSTALLERS CHOICE SNAPRAX QUICK ASSEMBLY NON-WELDED RACK 21RUX20D

#### SR21

##### Features & Benefits:

- Installers Choice quick assembly SnapRax format
- User assembled in less than 15 minutes typical
- 21RU high and 20 inches deep
- Sturdy, UL listed, and convenient
- Includes base, top, main channels and side struts

##### Application:

- Installation of head end where lead times are not acceptable
- Head end A/V and IT installs



### INSTALLERS CHOICE SNAPRAX QUICK ASSEMBLY NON-WELDED RACK 29RUX20D

#### SR29

##### Features & Benefits:

- Installers Choice quick assembly SnapRax format
- User assembled in less than 15 minutes typical
- 29RU high and 20 inches deep
- Sturdy, UL listed, and convenient
- Includes base, top, main channels and side struts

##### Application:

- Installation of head end where lead times are not acceptable
- Head end A/V and IT installs



**CUSTOM RACK HEADERS**  
PAGE 219





## INSTALLERS CHOICE SNAPRAX QUICK ASSEMBLY NON-WELDED RACK 37RUX20D

### SR37

#### Features & Benefits:

- Installers Choice quick assembly SnapRax format
- User assembled in less than 15 minutes typical
- 37RU high and 20 inches deep
- Sturdy, UL listed, and convenient
- Includes base, top, main channels and side struts

#### Application:

- Installation of head end where lead times are not acceptable
- Head end A/V and IT installs



**UNIVERSAL MOUNTING BRACKET FOR DEVICES**  
**DIGI-PMK1**  
See Page: 163



## INSTALLERS CHOICE SNAPRAX QUICK ASSEMBLY NON-WELDED RACK 43RUX20D KITTED

### SR43

#### Features & Benefits:

- Installers Choice quick assembly SnapRax standard kit
- User assembled in less than 15 minutes typical
- 43RU high and 20 inches deep
- Sturdy, UL listed, and convenient
- Includes base, top, main channels and side struts, 4 shelves, 1 drawer and PDU

#### Application:

- Installation of head end where lead times are not acceptable
- Head end A/V and IT installs



**FIBER OPTIC ENCLOSURES**  
PAGE 210



## INSTALLERS CHOICE SNAPRAX QUICK ASSEMBLY NON-WELDED RACK 43RUX20D KITTED

### SR43-26

#### Features & Benefits:

- Installers Choice quick assembly SnapRax standard kit
- User assembled in less than 15 minutes typical
- 43RU high and 20 inches deep
- Sturdy, UL listed, and convenient
- Includes base, top, main channels and side struts, 4 shelves, 1 drawer and PDU

#### Application:

- Installation of head end where lead times are not acceptable
- Head end A/V and IT installs



**New Website**  
[www.LibAV.com](http://www.LibAV.com)  
**BETTER, STRONGER, EXPANSIVE!**



## INSTALLERS CHOICE SNAPRAX QUICK ASSEMBLY NON-WELDED RACK 43RUX20D KITTED

### SR43-K1HP

#### Features & Benefits:

- Installers Choice quick assembly SnapRax standard kit
- User assembled in less than 15 minutes typical
- 43RU high and 20 inches deep
- Sturdy, UL listed, and convenient
- Includes base, top, main channels and side struts, 4 shelves, 1 drawer and PDU

#### Application:

- Installation of head end where lead times are not acceptable
- Head end A/V and IT installs

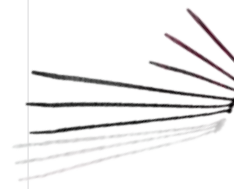

**TIE UP THE LOOSE ENDS**  
**CABLE TIES**  
Page 258

## INSTALLERS CHOICE SNAPRAX QUICK ASSEMBLY 20D BASE UNIT WITH CASTERS

### SR-B



#### Features & Benefits:

- Installers Choice quick assembly SnapRax 20D base unit
- User assembled in less than 15 minutes typical
- 20 inches deep, casters and leveler included
- Sturdy, UL listed, and convenient

#### Application:

- Installation of head end where lead times are not acceptable
- User configurable parts for ala carte rack building or modification
- Head end A/V and IT installs



### CUSTOM RACK HEADERS PAGE 219



## INSTALLERS CHOICE SNAPRAX QUICK ASSEMBLY 20D TOP ASSEMBLY

### SR-T



#### Features & Benefits:

- Installers Choice quick assembly SnapRax 20D top assembly
- User assembled in less than 15 minutes typical
- 20 inches deep, casters and leveler included
- Sturdy, UL listed, and convenient

#### Application:

- Installation of head end where lead times are not acceptable
- User configurable parts for ala carte rack building or modification
- Head end A/V and IT installs



### FIBER OPTIC PATCH PANELS See Liberty's Fiber Optic patch panels Page 207

## INSTALLERS CHOICE SNAPRAX QUICK ASSEMBLY 2RU FAN PACK

### SR-QFD2-4



#### Features & Benefits:

- Installers Choice quick assembly SnapRax 2RU Fan Pack
- User assembled in less than 15 minutes typical
- 4 Fans and display
- Sturdy, UL listed, and convenient

#### Application:

- Installation of head end where lead times are not acceptable
- User configurable parts for ala carte rack building or modification
- Head end A/V and IT installs



## INSTALLERS CHOICE SNAPRAX QUICK ASSEMBLY 3RU DRAWER KIT

### SR-DR3



#### Features & Benefits:

- Installers Choice quick assembly SnapRax 3RU drawer kit
- User assembled in less than 15 minutes typical
- 3RU height
- Sturdy, UL listed, and convenient

#### Application:

- Installation of head end where lead times are not acceptable
- User configurable parts for ala carte rack building or modification
- Head end A/V and IT installs



### INSTALLER'S CHOICE WALL BOXES See Page: 258



## INSTALLERS CHOICE SNAPRAX QUICK ASSEMBLY 43RU MAIN CHANNELS

### SR43-R

#### Features & Benefits:

- Installers Choice quick assembly SnapRax main channels
- User assembled in less than 15 minutes typical
- 43RU high
- Sturdy, UL listed, and convenient

#### Application:

- Installation of head end where lead times are not acceptable
- User configurable parts for ala carte rack building or modification
- Head end A/V and IT installs



#### CUSTOMER SERVICE

We offer technical assistance on all of our products or applications! Call us at 800-530-899 or email: [orders@LibAV.com](mailto:orders@LibAV.com)



## INSTALLERS CHOICE SNAPRAX QUICK ASSEMBLY STRAIGHT LACING BAR 5-PACK

### SR-LB

#### Features & Benefits:

- Installers Choice quick assembly SnapRax straight lacing bars
- User assembled in less than 15 minutes typical
- 5-pack
- Sturdy, UL listed, and convenient

#### Application:

- Installation of head end where lead times are not acceptable
- User configurable parts for ala carte rack building or modification
- Head End A/V and IT installs



## INSTALLERS CHOICE SNAPRAX QUICK ASSEMBLY 1RU SOLID BLANKING PANEL

### SR-BPS1

#### Features & Benefits:

- Installers Choice quick assembly SnapRax 1RU solid blanking panel
- User assembled in less than 15 minutes typical
- 1RU height
- Sturdy, UL listed, and convenient

#### Application:

- Installation of head end where lead times are not acceptable
- User configurable parts for ala carte rack building or modification
- Head end A/V and IT installs



**FIBER OPTIC ENCLOSURES**  
PAGE 210

## INSTALLERS CHOICE SNAPRAX QUICK ASSEMBLY 1RU VENTED BLANKING PANEL

### SR-BPHS1

#### Features & Benefits:

- Installers Choice quick assembly SnapRax 1RU vented blanking panel
- User assembled in less than 15 minutes typical
- 1RU height
- Sturdy, UL listed, and convenient

#### Application:

- Installation of head end where lead times are not acceptable
- User configurable parts for ala carte rack building or modification
- Head end A/V and IT installs

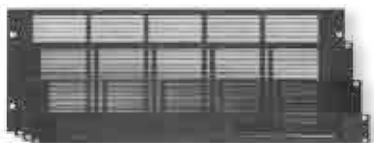

#### TECH SPECS

Up-to-date and complete tech specs for all products available at [www.LibAV.com](http://www.LibAV.com)

## INSTALLERS CHOICE SNAPRAX QUICK ASSEMBLY 1RU SOLID BLANKING PANEL

### SR-BPS2

#### Features & Benefits:

- Installers Choice quick assembly SnapRax 1RU solid blanking panel
- User assembled in less than 15 minutes typical
- 1RU height
- Sturdy, UL listed, and convenient

#### Application:

- Installation of head end where lead times are not acceptable
- User configurable parts for ala carte rack building or modification
- Head end A/V and IT installs

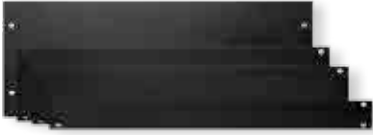

### CUSTOM RACK HEADERS PAGE 219



## INSTALLERS CHOICE SNAPRAX QUICK ASSEMBLY 1RU VENTED BLANKING PANEL

### SR-BPHS2

#### Features & Benefits:

- Installers Choice quick assembly SnapRax 1RU vented blanking Panel
- User assembled in less than 15 minutes typical
- 1RU height
- Sturdy, UL listed, and convenient

#### Application:

- Installation of head end where lead times are not acceptable
- User configurable parts for ala carte rack building or modification
- Head end A/V and IT installs

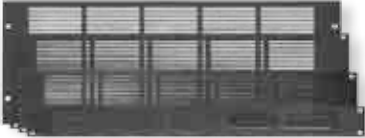

## INSTALLERS CHOICE SNAPRAX QUICK ASSEMBLY 1RU SOLID BLANKING PANEL

### SR-BPS3

#### Features & Benefits:

- Installers Choice quick assembly SnapRax 1RU solid blanking panel
- User assembled in less than 15 minutes typical
- 1RU height
- Sturdy, UL listed, and convenient

#### Application:

- Installation of head end where lead times are not acceptable
- User configurable parts for ala carte rack building or modification
- Head end A/V and IT installs



**New Website**  
[www.LibAV.com](http://www.LibAV.com)  
**BETTER, STRONGER,  
EXPANSIVE!**

## INSTALLERS CHOICE SNAPRAX QUICK ASSEMBLY 1RU VENTED SHELF

### SR-SH1

#### Features & Benefits:

- Installers Choice quick assembly SnapRax 1RU vented shelf
- User assembled in less than 15 minutes typical
- 1RU height
- Sturdy, UL listed, and convenient

#### Application:

- Installation of head end where lead times are not acceptable
- User configurable parts for ala carte rack building or modification
- Head end A/V and IT installs



**INSTALLERS CHOICE SNAPRAX QUICK ASSEMBLY 1RU VENTED SHELF**

**SR-SHS1**

**Features & Benefits:**

- Installers Choice quick assembly SnapRax 1RU vented shelf
- User assembled in less than 15 minutes typical
- 1RU height
- Sturdy, UL listed, and convenient

**Application:**

- Installation of head end where lead times are not acceptable
- User configurable parts for ala carte rack building or modification
- Head end A/V and IT installs



**WIRELESS HDMI**  
Send signals through walls!  
**SKYPLAY-HD**  
See Page: 149

**INSTALLERS CHOICE SNAPRAX QUICK ASSEMBLY 1RU VENTED SHELF**

**SR-SH2**

**Features & Benefits:**

- Installers Choice quick assembly SnapRax 1RU vented shelf
- User assembled in less than 15 minutes typical
- 1RU height
- Sturdy, UL listed, and convenient

**Application:**

- Installation of head end where lead times are not acceptable
- User configurable parts for ala carte rack building or modification
- Head end A/V and IT installs



**FIBER OPTIC ENCLOSURES**  
PAGE 210

**INSTALLERS CHOICE SNAPRAX QUICK ASSEMBLY 1RU VENTED SHELF**

**SR-SH3**

**Features & Benefits:**

- Installers Choice quick assembly SnapRax 1RU vented shelf
- User assembled in less than 15 minutes typical
- 1RU height
- Sturdy, UL listed, and convenient

**Application:**

- Installation of head end where lead times are not acceptable
- User configurable parts for ala carte rack building or modification
- Head end A/V and IT installs



**CUSTOM RACK HEADERS**  
PAGE 219



# HDMI ADAPTER RING

Keep your adapters where they need to be & immediately accessible for your mobile content presentation podium, boardroom, or docking station!

**DL-AR**

**PERFECT FOR:**

- Adapting various mobile content devices to HDMI
- Interfacing Laptops, Macs, iPad, Smartphone to HDMI

SEE PAGE 132



**DIGITALINX™**





**LIBERTY**  
AV SOLUTIONS  
Distributed Product ★★★

# TOOLS & ACCESSORIES

**RUN WITH US**

## C-TEC<sup>2</sup>



### C-TEC<sup>2</sup> COMPLETE TOOL KIT FOR TERMINATION OF ALL CONNECTORS UP TO RG6 SIZE

#### COMPRESSION C-TEC<sup>2</sup> TOOL KIT

##### Features & Benefits:

- Full tooling set up for termination of C-Tec<sup>2</sup> connectors
- All cables up to RG6 quad shield (RG11 not included)
- Kit includes: CM-TOOL, CM-206-L, CM-23/25, CM-59/6, CM-HOLSTER, CM-MINI

#### CM-TOOL-PAC

##### Application:

- Termination of C-Tec<sup>2</sup> compression connectors up to RG6
- Termination of other brand F compression plugs



WATCH IT NOW!  
C-TEC<sup>2</sup> TERMINATION

## C-TEC<sup>2</sup>



### C-TEC<sup>2</sup> LINEAR COMPRESSION TOOL FOR ALL CONNECTORS UP TO RG6 SIZE

#### COMPRESSION TOOL

##### Features & Benefits:

- Aircraft aluminum tool frame for lightweight durability
- Universal die flips for BNC/RCA and F plugs
- Compresses all BellCore compliant F plugs



#### CM-TOOL

##### Application:

- Termination of compression C-Tec<sup>2</sup> and ConneTec<sup>®</sup> connectors
- Termination of other brands F compression connectors



**C-TEC<sup>2</sup> CONNECTORS**  
See Page 139

## C-TEC<sup>2</sup>

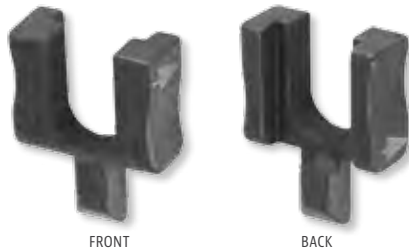

FRONT

BACK

### C-TEC<sup>2</sup> REPLACEMENT DIE FOR THE CM-TOOL

#### DIE REPLACEMENT TOOL

##### Features & Benefits:

- Replacement die the CM-TOOL

#### CM-TOOL-DIE

##### Application:

- Replacement for flip die on CM-TOOL



**DIGITAL VIDEO BULK**  
Reliable options for any type of professional installation  
See Page: 25

## C-TEC<sup>2</sup>



### C-TEC<sup>2</sup> CABLE CUTTER FOR UP TO RG6 QUAD COPPER CLAD STEEL COAX CABLE

#### CUTTER TOOL

##### Features & Benefits:

- Convex scissor blade action to cut coaxial cable
- Cuts copper to 14 AWG and copper clad steel to 18 AWG
- Durable and inexpensive
- Perfect to cut coaxial cables without flattening them

#### CM-206-L

##### Application:

- Termination preparation of coaxial cables for connectors



## C-TEC<sup>2</sup> COAX CONNECTORS FOR RG59, RG6, RG11, MINI RGB CONNECTORS

- Ferrule-less F & M series design allows any sized cable constructions from virtually any manufacturer to fit these connectors
- Perfect for RF video - CATV, MATV, direct broadcast satellite



## C-TEC<sup>2</sup>



### C-TEC<sup>2</sup> COLORED STRAIN RELIEF CONNECTOR ID BANDS

#### BANDS FOR ID

#### Features & Benefits:

- Slips on easily to our CM connector line
- Removable
- Packaged in bags of 100 pieces

AVAILABLE COLORS: ● ● ● ● ● ● ●  
PART# COLOR ID: RED GRN BLU ORG WHT YEL BLK

#### CM-R

#### Application:

- ID rings for marking CoaxMaster CM series RCA, BNC, and F connectors

## C-TEC<sup>2</sup>



### C-TEC<sup>2</sup> CABLE STRIP TOOL FOR C-TEC<sup>2</sup> RG59 AND RG6 CABLE

#### STRIPPER TOOL

#### Features & Benefits:

- 1/4" x 1/4" standard F connector strip (yellow cartridge)
- Stop bracket to facilitate strip lengths
- Number of spins equates to depth of cut
- Always check your strip length

#### CM-59/6

#### Application:

- Cable Preparation for ConnectTec<sup>®</sup> compression connectors
- For RG59 single, dual, tri, and quad shield cables
- For RG6 single, dual, tri, and quad shield cables
- Plenum and non-plenum cables

## C-TEC<sup>2</sup>



### C-TEC<sup>2</sup> CABLE STRIP TOOL REPLACEMENT BLADE FOR CM-59/6

#### BLADE REPLACEMENT

#### Features & Benefits:

- 1/4" x 1/4" standard F connector strip (yellow cartridge)

#### CM-59/6-BLADE

#### Application:

- Replacement cartridge for CM-59/6 tool
- Replenishment of dull blades on the CM-59/6 tool



**New Website**  
[www.LibAV.com](http://www.LibAV.com)  
**BETTER, STRONGER, EXPANSIVE!**

## C-TEC<sup>2</sup>



### C-TEC<sup>2</sup> CABLE STRIP TOOL FOR C-TEC<sup>2</sup> MINI SOLID COAXIAL CABLE

#### STRIPPER TOOL

#### Features & Benefits:

- 1/4" x 1/4" standard F connector strip (blue cartridge)
- Stop bracket to facilitate strip lengths
- Number of spins equates to depth of cut
- Always check your strip length

#### CM-23/25

#### Application:

- Cable preparation for ConnectTec<sup>®</sup> compression connectors
- For mini-RG59 23 AWG single & dual shield cables
- For mini-high resolution 25 AWG dual shield cables
- Plenum and non-plenum cables
- QuickLinx cable and connector system

## C-TEC<sup>2</sup>



### C-TEC<sup>2</sup> CABLE STRIP TOOL REPLACEMENT BLADE FOR CM-23/25

#### BLADE REPLACEMENT

#### Features & Benefits:

- 1/4" x 1/4" standard F connector strip (blue cartridge)
- Replacement cartridge for CM-23/25 tool

#### CM-23/25-BLADE

#### Application:

- Replenishment of dull blades on the CM-23/25 tool



**BARGAIN BIN**  
**PRICES DROP DAILY**  
[www.LibAV.com](http://www.LibAV.com)

## C-TEC<sup>2</sup>



### C-TEC<sup>2</sup> CABLE STRIP TOOL FOR C-TEC<sup>2</sup> MINI STRANDED COAXIAL CABLE

#### STRIPPER TOOL

##### Features & Benefits:

- 4mm x 1/4" 2-stage connector strip (black cartridge)
- Stop bracket to facilitate strip lengths
- Number of spins equates to depth of cut
- Always check your strip length

#### CM-MINI

##### Application:

- Cable preparation for ConneCTec<sup>®</sup> compression connectors
- For 26 AWG stranded mini high resolution RGB cables
- For 25 AWG stranded Mini RG59 RGB cables
- Plenum and non-plenum cables

## C-TEC<sup>2</sup>



### C-TEC<sup>2</sup> CABLE STRIP TOOL REPLACEMENT BLADE FOR CM-MINI

#### BLADE REPLACEMENT

##### Features & Benefits:

- 4mm x 1/4" 2-stage connector strip (black cartridge)
- Stop bracket to facilitate strip lengths
- Number of spins equates to depth of cut
- Always check your strip length

#### CM-MINI-BLADE

##### Application:

- Cable preparation for ConneCTec<sup>®</sup> compression connectors
- For 26 AWG stranded mini high resolution RGB cables
- For 25 AWG stranded mini RG59 RGB cables
- Plenum and non-plenum cables

## C-TEC<sup>2</sup>



### C-TEC<sup>2</sup> LINEAR COMPRESSION TOOL FOR RG11 SIZE

#### COMPRESSION TOOL

##### Features & Benefits:

- Aircraft aluminum tool frame for lightweight durability
- RG11 universally adjustable for any brand
- Compresses all BellCore compliant F plugs

#### CM-TOOL-11

##### Application:

- Termination of compression C-Tec<sup>2</sup> and ConneCTec<sup>®</sup> connectors
- Termination of other brands F compression connectors



**COOL SPOOL SYSTEM<sup>®</sup>**  
 Our exclusive reel box and hand truck means tangle-free pulls and total control  
 See Page: 253

## C-TEC<sup>2</sup>



### C-TEC<sup>2</sup> CABLE STRIP TOOL FOR C-TEC<sup>2</sup> RG11 AND RG8 CABLE

#### STRIPPER TOOL

##### Features & Benefits:

- 1/4" x 1/4" standard F connector strip
- Number of spins equates to depth of cut
- Always check your strip length

#### CM-8/11

##### Application:

- Cable preparation for ConneCTec<sup>®</sup> compression connectors
- For RG11 single, dual, tri, and quad shield cables
- For RG8 single, dual shield cables
- Plenum and non-plenum cables

### COLORED STRAIN RELIEF CONNECTOR BOOTS

#### BOOT ACCESSORY

##### Features & Benefits:

- Perfect-fit silicone MHR connector strain relief
- Fits 26 and 25 AWG MHR coaxial cable BNC and RCA plugs
- BNC's: MHR-BNC, 112491-10, 112491-11, 112161-10
- RCA: MHR-RCA
- Cables: Liberty 26 AWG and 25 AWG MHR cables
- Packaged in 100-piece packages

AVAILABLE COLORS: ● ● ● ● ○ ● ●  
 PART# COLOR ID: RED GRN BLU ORG WHT YEL BLK

#### BMHR

##### Application:

- Cable strain relief and connector dressing for mini hi-res BNC & RCA connectors
- Professional appearance installations and applications





## CRIMP TOOL FOR D-SUB CONNECTORS

### CRIMPER TOOL

#### Features & Benefits:

- DB9, DB15, DB25 low density (2-row) connector crimp tool
- Has contact locator function for ease of use

**1646**

#### Application:

- RS-232, RS-422, RS-485 data
- Audio, video, control field termination



**BARGAIN BIN!**  
**PRICES DROP DAILY**  
Check back daily for lower prices on overstock items!  
[www.LibAV.com](http://www.LibAV.com)



## STRIP TOOL FOR MINI HIGH RESOLUTION COAX CABLE

### STRIPPER TOOL

#### Features & Benefits:

- 3-stage strip for Amphenol Connex and Liberty BNC plugs
- Adjustable for RG6 dual shield to mini high res cable
- Ratcheting closure permits staged depth cuts
- For Liberty MHR stranded and solid cable
- Precision strip tool, requires user set up

**1258**

#### Application:

- Cable preparation for MHR-BNC, MHR-RCA, 112491-10
- Cable preparation for Amphenol-Connex BNC, TNC plugs



## PALADIN CABLE STRIP TOOL FOR BNC (3 PIECE), TNC, AND N CONNECTORS

### STRIPPER TOOL

#### Features & Benefits:

- 3-step rotary strip tool
- User-adjustable for different cable diameters
- Calibrated for Amphenol-Connex BNC, TNC, N connectors
- Up to 7mm cable OD (RG6 Dual Shield)
- Includes hex wrench for blade depth adjustment

**1281**

#### Application:

- Strip and prepare coaxial cables for connector termination
- Amphenol-Connex connectors primary
- RG179 through RG6 sized cables



## AMPHENOL CONNEX STANDARD CRIMP TOOL FRAME

### CRIMPER TOOL

#### Features & Benefits:

- Crimp tool frame for 47-2\* crimp dies, purchase dies separately
- Crimp tool for a variety of BNC connectors by simply installing the appropriate die set
- Works with most Liberty BNC's designed to fit on nearly all of Liberty's cables.
- Standard leverage tool

**47-10000**

#### Application:

- Termination of BNC Amphenol-Connex, Liberty brand connectors



## AMPHENOL CONNEX CRIMP TOOL AND DIE FOR RG58 AND RG59 TOOL FRAME

### CRIMPER & DIE

#### Features & Benefits:

- Full crimp tool and pre-loaded crimp die
- 47-10000 frame and 47-20000 crimp die
- 50 Ohm/75 Ohm RG58, RG59, RG62 coaxial cables
- Pin crimp .068", ferrule crimp .213", .255"

**47-10070**

#### Application:

- Terminating BNC, TNC, N, SMA, SMB, SMC plugs and jacks
- RG58 and RG59 sized coaxial cables



**PREMIUM CONNECTORS**  
Options for any type of professional installation  
See Page: 117



**AMPHENOL CONNEX CRIMP DIE FOR RG58 AND RG59 TOOL FRAME**

**DIE REPLACEMENT**

**Features & Benefits:**

- Crimp die for the 47-10000 tool frame
- 50 Ohm/75 Ohm RG58, RG59, RG62 coaxial cables
- Pin crimp .068", ferrule crimp .213", .255"

**47-20000**

**Application:**

- Terminating BNC, TNC, N, SMA, SMB, SMC plugs and jacks
- RG58 and RG59 sized coaxial cables



**COMPREHENSIVE VIDEO TRAINING**  
[www.LibAV.com](http://www.LibAV.com)>Videos



**AMPHENOL CONNEX CRIMP DIE FOR RG59 AND RG6 TOOL FRAME**

**DIE REPLACEMENT**

**Features & Benefits:**

- Crimp die for the 47-10000 tool frame
- Universal true 75-Ohm RG59, RG6, Belden 8281 crimp die
- Pin crimp .042", .068", ferrule crimp .255", .324"

**47-20001**

**Application:**

- Terminating BNC, TNC, N plugs and jacks
- RG59 and RG6 sized coaxial cables



**AMPHENOL CONNEX CRIMP DIE FOR RG59 AND RG6 FERRULES TOOL FRAME**

**DIE REPLACEMENT**

**Features & Benefits:**

- Crimp die for the 47-10000 tool frame
- Cable sizes RG59 and RG6 ferrule only
- Ferrule crimp sizes .255", .320" and .350"

**47-20026**

**Application:**

- Ferrule crimp on true 75-Ohm BNC plugs
- Installer using 12-indent pin crimp tool for the pin



**New Website**  
[www.LibAV.com](http://www.LibAV.com)  
**BETTER, STRONGER, EXPANSIVE!**



**AMPHENOL CONNEX CRIMP DIE FOR RG8 RF400 TOOL FRAME**

**DIE REPLACEMENT**

**Features & Benefits:**

- Crimp die for the 47-10000 tool frame
- Cable sizes RF400, RG8 10 AWG solid
- Pin crimp .118", ferrule crimp .429"

**47-20027**

**Application:**

- Terminating BNC, TNC, N plugs and jacks
- 50 Ohm wireless broadcast cables



**AMPHENOL CONNEX CRIMP DIE FOR MHR AND MINI-RG59 TOOL FRAME**

**DIE REPLACEMENT**

**Features & Benefits:**

- Hex crimp die for the 47-10000 tool frame
- Mini-high resolution coaxial cable crimping die
- .042" and .068" center pin hex crimp
- .128" and .178" ferrule hex crimp

**47-20250**

**Application:**

- Crimps MHR-BNC, MHR-RCA, 112491-10, 112491-11, 112161-10
- Crimps BNC-12, BNC-13, 112955, 112559, 2065-11-9
- Crimps BNC-NICKEL, BNC-GOLD-CL
- 26 AWG stranded mini high res coax termination
- 25 AWG solid mini high res coax termination
- 25 AWG stranded mini-RG59 coax termination
- 23 AWG solid mini-RG59 coax termination including SDI



**HAND TRUCK FOR TRANSPORTATION OF A/V EQUIPMENT AND COOL SPOOL SYSTEM® CABLE BOXES**

**MATERIAL HANDLING**

**Features & Benefits:**

- Standard heavy duty hand truck
- Extendable toe for larger items
- Converts easily to a 4-wheeled cart
- Custom designed to perfectly match dimensions of Liberty's 14 inch Cool Spool System® reel boxes
- Use with standard straps or bunnies (not sold by Liberty)

**LAV-HDTK**

**Application:**

- Equipment material handling
- Cool Spool cable box dispensing and moving

# COOL SPOOL SYSTEM®

## DURABLE, VERSATILE, & SAVES LABOR COSTS!

Double-enforced construction means no torn handles and tough enough to withstand the most rigorous handling.



Tension control handle eliminates tangles, bird's nests and wasted cable.

Multiple dispensing slots allow pulling cables through 2 or more boxes.

### OUR CUSTOM-DESIGNED HAND TRUCK & REEL BOXES SAVE TIME AND MONEY ON ANY TYPE OF INSTALLATION JOB!

Our exclusive Cool Spool System® reel box and hand truck means tangle-free pulls and total control!

Three standardized reel/boxes available to accommodate a variety of cables – Cat 5e/6, RG59/6 coax, mini-coax and speaker cable.

Tension-control side knobs eliminates tangles and wasted cable while our custom-designed hand truck with extendable toe converts from a dolly to a full-sized transportation cart in seconds.



**DID YOU KNOW?**

**THE LIBERTY EDGE**

You can always save more time and money with THE LIBERTY EDGE! Check out all of these exclusive services at [www.LibAV.com](http://www.LibAV.com) or contact your rep today to make Liberty an extension of your workforce!

# CATMASTER-HD® PERFECT CAT CABLE TERMINATION SYSTEM

CATMASTER® COMPLETE TOOL KIT  
90131LW



**Features & Benefits:**

- 1 each heavy duty RJ45 crimp tool with cut off blades
- 1 bag of 50 Category 5e EZ-RJ45 plugs
- 1 each CYCLOPS UTP jacket strip tool
- 1 each round cable cutting tool for copper cable only

**Application:**

- Termination of RJ45 plugs and RJ25 (RJ11, RJ12) plugs
- Termination of EZ-RJ45 feed through plugs
- LAN and Balun support

**DID YOU KNOW?**

WE HAVE A VARIETY OF QUALITY RJ45 CONNECTORS TO FIT ANY BUDGET FOR YOUR PROFESSIONAL INSTALLATIONS!

SEE PAGE 136



**CATMASTER-HD®**



**CATMASTER® HEAVY DUTY CRIMP TOOL FOR RJ45 CONNECTORS**

**CRIMPER TOOL**

**Features & Benefits:**

- Modular plug crimp and cut action for EZ-RJ45
- 4P4C through 8P8C formats (RJ9/RJ11/RJ45)
- 75% better connector support to reduce issues
- Cable stripping blades in handle
- Works on standard non-CatMaster® RJ45 plugs
- Heavy duty design to support Cat 6 and shielded cables

**100054LW**

**Application:**

- LAN Category 3, 5e, 6 modular plug termination
- EZ-RJ45 and non-EZ-RJ45 modular plug termination

**CATMASTER-HD®**



**CATMASTER® REPLACEMENT BLADE SET FOR THE 100054LW LAN CRIMP TOOL**

**BLADE REPLACEMENT**

**Features & Benefits:**

- Full set of blades for conductor cutting and jacket strip

**100054BLLW**

**Application:**

- LAN Category 3, 5e, 6 modular plug termination
- EZ-RJ45 and non-EZ-RJ45 modular plug termination

**CATMASTER-HD®**



**CATMASTER® IMPACT TOOL FOR 110, 66, AND KRONE/ADC IDC LAN TERMINATIONS**

**IMPACT TOOL**

**Features & Benefits:**

- Impact tool with interchangeable blades
- 110, 66 Block and Krone/ADC formats and blades
- User adjustable impact force with dial in the handle
- Extra blade storage in handle
- Heavy duty

**13006**

**Application:**

- Voice, telecom, LAN cross connect and block termination
- Security, patch panel termination, audio and IR



**CATMASTER-HD®**



**CATMASTER® CABLE STRIP TOOL FOR U & UTP**

**STRIPPER TOOL**

**Features & Benefits:**

- Cigar cutter style
- Bidirectional, one shallow cutting and one deeper cutting

**15010**

**Application:**

- Scoring and stripping U/UTP Category 3,5e,6, and 6A cables
- Cable preparation for termination or punch down

**CATMASTER-HD®**



**RJ45 SNAG FREE CONNECTOR STRAIN RELIEF BOOTS**

**BOOT ACCESSORY**

**Features & Benefits:**

- Push over Boot style strain relief for standard RJ45 plugs
- Snag free design covers the release latch
- Category 5e and Category 6
- Durable and unbreakable
- Sold in packages of 50

**BOOT-S**

**Application:**

- TIA/EIA Compliant Category 6 installations strain relief
- LAN, Balun, Media over TWP connector protection

AVAILABLE COLORS: ● ● ● ○ ● ●  
PART# COLOR ID: RED GRN BLU WHT YEL BLK

**HD TERMINATION SYSTEM**



**CRIMP TOOL FOR HD TERMINATION SYSTEM**

**CRIMP TOOL**

**Features & Benefits:**

- Ribbon cable cut off slot calibrated to the sleeves
- IDC compression cavity
- Cable strain relief crimp die on the handle

**DL-HDMHT**

**Application:**

- Field termination of HD Termination System® HDMI cables
- Digital multimedia routing and cabling solutions



**New Website**  
[www.LibAV.com](http://www.LibAV.com)  
**BETTER, STRONGER, EXPANSIVE!**

# HD TERMINATION SYSTEM

## CUSTOMIZE YOUR HDMI CABLE LENGTHS



- Customize your HD cable lengths to professionally dress racks and minimize excess cable
- Locking HDMI connector technology increases retention up to 400%
- Supports HDMI with ethernet, CEC and bi-directional audio formats



**HD CABLE TERMINATION SYSTEM**  
Get everything you need!  
See Page 30

**TERMINATE IN 5 MINUTES!**





**CORNING UNICAM FIBER OPTIC TERMINATION KIT**

**FIBER OPTIC TOOL KIT**

**Features & Benefits:**

- Termination tooling kit for SC, LC, and ST connectors
- Ergonomic suitcase design can go anywhere
- All supplies included, DVD and printed instructions
- Visual fault locator built into the termination tool
- Precision cleaver
- Indicator shows good termination before crimping

**TKT-UNICAM-PFC**

**Application:**

- Applying corning pretium UNICAM fiber optic connectors
- Does not work with other brand connectors
- Terminates 95-\* series connectors in LC, ST, and SC
- Connectors for 62.5/125, 50/125, and singlemode fiber



**CORNING UNICAM TERMINATION SYSTEM FIBER CLEANING FLUID**

**FIBER OPTIC ACCESSORY**

**Features & Benefits:**

- Single dispensing bottle of fiber cleaning fluid
- Replenishment for the TKT-UNICAM-PFC tool kit
- Can be used with any fiber or fiber tool kit



**FIBER OPTIC SOLUTIONS**  
Page 193

**FCC-CLEANER-FIBER**

**Application:**

- Fiber optic termination preparation
- Replenishment of UNICAM tool kit supplies



**CORNING UNICAM TERMINATION SYSTEM FIBER CLEANING CLOTHS**

**FIBER OPTIC ACCESSORY**

**Features & Benefits:**

- Single dispensing bottle of fiber cleaning cloths
- Replenishment for the TKT-UNICAM-PFC tool kit
- Can be used with any fiber or fiber tool kit

**FCC-WIPES**

**Application:**

- Fiber optic termination preparation
- Replenishment of UNICAM tool kit supplies



**HEAT SHRINK 1/2" PRE-CUT KIT OF 25 PIECES AT 6 INCHES**

**HEAT SHRINK TUBE**

**Features & Benefits:**

- 1/2 inch inner diameter
- 2:1 shrink ratio
- UL or ETL listed
- Pre-cut into 25 pieces at 6 inches each

**HSK-2:1-1/2**

**Application:**

- Protection of solder junctions
- Coverage of jacket strip junctions
- Circuit identification and marking
- Non-plenum



**DIGITAL VIDEO BULK**  
Reliable options for any type of professional installation  
See Page: 25



**HEAT SHRINK 1/4" PRE-CUT KIT OF 25 PIECES AT 6 INCHES**

**HEAT SHRINK TUBE**

**Features & Benefits:**

- 1/4 inch inner diameter
- 2:1 shrink ratio
- UL or ETL listed
- Pre-cut into 25 pieces at 6 inches each

**HSK-2:1-1/4**

**Application:**

- Protection of solder junctions
- Coverage of jacket strip junctions
- Circuit identification and marking
- Non-plenum



## HEAT SHRINK 1/8" PRE-CUT KIT OF 25 PIECES AT 6 INCHES

### HEAT SHRINK TUBE

#### Features & Benefits:

- 1/8 inch inner diameter
- 2:1 shrink ratio
- UL or ETL listed
- Pre-cut into 25 pieces at 6 inches each

### HSK-2:1-1/8

#### Application:

- Protection of solder junctions
- Coverage of jacket strip junctions
- Circuit identification and marking
- Non-plenum



**BARGAIN BIN!**  
**PRICES DROP DAILY**  
Check back daily for lower prices on overstock items!  
[www.LibAV.com](http://www.LibAV.com)



## HEAT SHRINK 3/16" PRE-CUT KIT OF 25 PIECES AT 6 INCHES

### HEAT SHRINK TUBE

#### Features & Benefits:

- 3/16 inch inner diameter
- 2:1 shrink ratio
- UL or ETL listed
- Pre-cut into 25 pieces at 6 inches each

### HSK-2:1-3/16

#### Application:

- Protection of solder junctions
- Coverage of jacket strip junctions
- Circuit identification and marking
- Non-plenum



## HEAT SHRINK 3/8" PRE-CUT KIT OF 25 PIECES AT 6 INCHES

### HEAT SHRINK TUBE

#### Features & Benefits:

- 3/8 inch inner diameter
- 2:1 shrink ratio
- UL or ETL listed
- Pre-cut into 25 pieces at 6 inches each

### HSK-2:1-3/8

#### Application:

- Protection of solder junctions
- Coverage of jacket strip junctions
- Circuit identification and marking
- Non-plenum



**New Website**  
[www.LibAV.com](http://www.LibAV.com)  
**BETTER, STRONGER, EXPANSIVE!**



## TECHFLEX® EXPANDABLE SLEEVING .75 INCH ID

### EXPANDABLE SLEEVING ACCESSORY

#### Features & Benefits:

- 3/4" Inner diameter
- Black nylon mesh
- 250 foot spools

### TF-PET-75

#### Application:

- Cover and protect wiring harnesses
- Group and organize wires & cables aesthetically for exposed runs
- Non-plenum



## TECHFLEX® EXPANDABLE SLEEVING 1.25 INCH ID

### EXPANDABLE SLEEVING ACCESSORY

#### Features & Benefits:

- 1.25" Inner diameter
- Black nylon mesh
- 250 foot spools

### TF-PET-1.25



#### Application:



- Cover and protect wiring harnesses
- Group and organize wires & cables aesthetically for exposed runs
- Non-plenum

	<b>CABLE TIE WHITE NYLON 66 UL LISTED</b> <b>CABLE TIE ACCESSORY, NON-PLENUM</b>	<b>CT</b>
	<b>Features &amp; Benefits:</b> <ul style="list-style-type: none"> <li>· White (natural) nylon 66</li> <li>· 18-50 lb. tensile strength rating depending on length</li> <li>· UL listed</li> <li>· 100-pack bags standard</li> </ul>	<b>Application:</b> <ul style="list-style-type: none"> <li>· Indoor cable bundling, routing, and fastening</li> <li>· 4 inch length: .25" max bundle diameter recommended, 18 lb. tensile strength rating</li> <li>· 6 inch length: 1.5" max bundle diameter recommended, 18 lb. tensile strength rating</li> <li>· 8 inch length: 2" max bundle diameter recommended, 40 lb. tensile strength rating</li> <li>· 11 inch length: 3" max bundle diameter recommended, 50 lb. tensile strength rating</li> </ul>

	<b>CABLE TIE BURGUNDY PLENUM RATED</b> <b>CABLE TIE ACCESSORY, PLENUM &amp; NON-PLENUM</b>	<b>CT-P</b>
	<b>Features &amp; Benefits:</b> <ul style="list-style-type: none"> <li>· Burgundy poly</li> <li>· 40-50 lb. tensile strength rating depending on length</li> <li>· UL listed for air handling (plenum) spaces</li> <li>· 100-pack bags standard</li> </ul>	<b>Application:</b> <ul style="list-style-type: none"> <li>· Indoor cable bundling, routing, and fastening</li> <li>· 8 inch length: 2" max bundle diameter recommended, 40 lb. tensile strength rating</li> <li>· 12" inch length: 3" max bundle diameter recommended, 50 lb. tensile strength rating</li> <li>· 14 inch length: 4" max bundle diameter recommended, 50 lb. tensile strength rating</li> </ul>

	<b>CABLE TIE BLACK UV RESISTANT FOR INDOOR/OUTDOOR USE</b> <b>CABLE TIE ACCESSORY, NON-PLENUM</b>	<b>CT-UV</b>
	<b>Features &amp; Benefits:</b> <ul style="list-style-type: none"> <li>· Black UV-resistant nylon</li> <li>· 18-50 lb. tensile strength rating depending on length</li> <li>· UL listed</li> <li>· 100-pack bags standard</li> </ul>	<b>Application:</b> <ul style="list-style-type: none"> <li>· Indoor/outdoor cable bundling, routing, and fastening</li> <li>· 4 inch length: .25" max bundle diameter recommended, 18 lb. tensile strength rating</li> <li>· 6 inch length: 1.5" max bundle diameter recommended, 18 lb. tensile strength rating</li> <li>· 7 inch length: 1.75" max bundle diameter recommended, 50 lb. tensile strength rating</li> <li>· 8 inch length: 2" max bundle diameter recommended, 40 lb. tensile strength rating</li> <li>· 14 inch length: 4" max bundle diameter recommended, 50 lb. tensile strength rating</li> </ul>

 	<b>INSTALLER'S CHOICE® 10" X 10" RECESSED BACK WALL BOX WITH SURGE SUPPRESSION</b> <b>MOUNTING - FLAT PANEL</b>	<b>ICCB10-1</b>
	<b>Features &amp; Benefits:</b> <ul style="list-style-type: none"> <li>· Retrofit design for installation into pre-existing drywall</li> <li>· Integrated surge suppression</li> <li>· Low voltage section for A/V cables</li> <li>· Permits ultra low profile screen installations</li> <li>· 10 x 10 inch hole format</li> </ul>	<b>Application:</b> <ul style="list-style-type: none"> <li>· Flat Panel power and A/V cabling interface</li> <li>· Ultra low profile panels and mount support</li> <li>· Non-plenum</li> </ul>

 	<b>INSTALLER'S CHOICE® 12.5" X 12.5" RECESSED BACK WALL BOX WITH SURGE SUPPRESSION</b> <b>MOUNTING - FLAT PANEL</b>	<b>ICCB12-2</b>
	<b>Features &amp; Benefits:</b> <ul style="list-style-type: none"> <li>· Retrofit design for installation into pre-existing drywall</li> <li>· Integrated surge suppression</li> <li>· Low voltage section for A/V cables</li> <li>· Permits ultra low profile screen installations</li> <li>· 12.5 x 12.5 inch hole format</li> </ul>	<b>Application:</b> <ul style="list-style-type: none"> <li>· Flat Panel power and A/V cabling interface</li> <li>· Ultra low profile panels and mount support</li> </ul> <div style="border: 1px solid black; padding: 5px; margin-top: 10px;">  <b>BARGAIN BIN!</b>  <b>PRICES DROP DAILY</b>                      Check back daily for lower prices on overstock items!  <a href="http://www.LibAV.com">www.LibAV.com</a> </div>

# LOCKING HDMI WHEN YOU LOSE CONNECTIVITY YOU LOSE BUSINESS



Perfect Path's patented locking and high retention HDMI cable series boasts up to 25 lbs of retention, and equipped for 1080p and beyond!



HD-600B

HD-700

HD-1000

SEE PAGE 104 FOR PRODUCT DETAILS

NOW AVAILABLE HERE!



**LIBERTY**  
AV SOLUTIONS  
Distributed Product ★★★

**RUN WITH US**

www.LibAV.com | 800.530.8998



#### AWARD WINNING!

Winner of the 2009 Best Interconnect Device from Insight Media, PerfectPath cables continue to receive rave reviews from users across all audiences, including installers, gamers and HDTV owners.

1258.....	251	14-2C-KO+ .....	68	22-1P-CMP-EZ .....	8
1281.....	251	14-2C-P .....	51	22-1P-EZ .....	7
1646 .....	251	14-2C-PSH .....	51	22-2C .....	48
13006.....	254	14-2C-TTP .....	72	22-2C-P .....	55
15010 .....	255	14-2C-ZIP .....	71	22-2C-PSH .....	55
100020 .....	137	14-4C-DB .....	69	22-2C-SH.....	49
100035 .....	137	14-4C-EX+ .....	67	22-2C-SO-HT .....	62
100036 .....	137	14-4C-HT .....	70	22-2C-ST-HT.....	62
112116 .....	123	14-4C-KO+ .....	68	22-2P-CMP-SIAMEZ .....	9
112128 .....	122	14-4C-P .....	52	22-2P-INDSH .....	50
112562 .....	123	1401405012-I .....	138	22-2P-PINDSH .....	55
112563 .....	123	16-1P-UC.....	66	22-2P-PSH/UN .....	63
112951.....	122	16-2C .....	47	22-2P-SHEX.....	8
112955 .....	123	16-2C-DB .....	70	22-2P-SIAM-EZ.....	7
112957.....	122	16-2C-EX+ .....	67	22-3P-PINDSH.....	55
112975.....	123	16-2C-HT.....	71	22-4C .....	49
122108.....	123	16-2C-KO+ .....	68	22-4C-P.....	56
122112 .....	124	16-2C-P .....	52	22-4C-PSH.....	56
11108080034 .....	136	16-2C-PSH .....	52	22-4C-SH .....	49
10-2C-EX+ .....	66	16-2C-TTP .....	73	22-4C-SO-HT .....	63
10-2C-TTP.....	72	16-2C-VAN.....	40	22-4C-ST-HT .....	63
100 003B.....	137	16-4C-DB.....	70	22-4P-PINDSH.....	56
100010LW .....	137	16-4C-EX+ .....	67	22-6C .....	49
100 011LW .....	137	16-4C-HT .....	71	22-6C-PSH.....	57
100 026LW .....	136	16-4C-KO+ .....	68	22-6C-SH .....	50
100054BLLW .....	254	16-4C-P.....	52	22-8C-PSH.....	57
100054LW.....	254	16-4C-TTP.....	73	22-8C-SH .....	50
10005USOP.....	136	18-2C .....	47	23-MINI-CMP .....	28
111508080016-34 .....	136	18-2C-P .....	53	23-MINI-SD.....	26
111508080091C34.....	136	18-2C-PSH .....	53	24-1P-CMP-EZ .....	9
112161-10.....	124	18-2C-SH.....	47	24-1P-DIG.....	23
12-1P-UC .....	65	18-2C-TRSH .....	39	24-1P-P-DIG-AUDIO.....	23
12-2C.....	46	18-2P-INDSH.....	48	24-2P-P485.....	39
12-2C-DB.....	69	18-3C-P .....	53	24-2P-STAR .....	8
12-2C-EX+ .....	66	18-3C-PSH .....	53	24-4P-L5-EN.....	18
12-2C-P.....	51	18-4C.....	47	24-4P-L5-EN-DB.....	18
12-2C-TTP.....	72	18-4C-FPLR .....	62	24-4P-L5-HT.....	19
12-2C-ZIP .....	71	18-4C-P.....	54	24-4P-L5SH-EN.....	18
12-2P-UC.....	65	18-4C-PSH.....	54	24-4P-L6-EN .....	20
12-3C-P .....	51	18-4C-SH .....	48	24-4P-L6-EN-DB .....	20
12-4C .....	46	18-4C-TRSH.....	39	24-4P-L6-HT .....	20
12-4C-DB .....	69	18-CMP-VID-COAX .....	27	24-4P-L6ASH.....	21
12-4C-EX+ .....	66	18-CMR-SD.....	26	24-4P-L6SH .....	19
12FRIOMM6-D.....	196	20-2C-PSH.....	54	24-4P-P-L5-EN .....	22
12FRIOMM10-D.....	196	20-2C-SH.....	48	24-4P-P-L5SH .....	21
12FRIOSM-D .....	196	20-2C-TTPSH.....	73	24-4P-P-L6-EN .....	22
14-1P-UC.....	65	20-3C-PSH .....	54	24-4P-P-L6SH .....	22
14-2C .....	46	20-CMP-VID-COAX .....	27	24-4P-PLCSH .....	22
14-2C-DB .....	69	20-CMR-VIDEO .....	26	24-4P-SH.....	21
14-2C-EX+ .....	67	20SD-RCAM-M.....	114	24-4P-STR-L5-EN .....	19
14-2C-HT.....	70	22-10C-P .....	57	24-8P-L5E-SIAM .....	19

24-8P-L6-SIAM .....	20	ARMDHD .....	132	CCH-CP12-59 .....	209
2FRIMM10-BO .....	195	ARMDPHD.....	132	CCH-CP12-91.....	207
2FRIOMM10-BO .....	195	AUDIOCAT-SIAMESE.....	74	CCH-CP12-A8 .....	207
2FRIOMM6-D .....	197	AUDIOCAT+ .....	74	CCH-CP12-A9 .....	209
30-421.....	119	AV2FP.....	238	CCH-CP12-D3 .....	208
30-484.....	119	AV3500PC .....	237	CCH-CP12-E4 .....	208
30-487 .....	119	AVBAR6 .....	237	CCH-CP12-E6 .....	208
31-114.....	131	AVDA-8-F .....	146	CCH-CP12-E7.....	209
31D1-28200 .....	125	AVO-A2-F .....	171	CCH-CP12-G7 .....	208
32-281 .....	125	AVO-A2-WP-F.....	171	CD-9809M.....	126
32-284.....	125	AVO-A2-WP110.....	171	CD-9809S .....	126
32-3109BU.....	120	AVO-A2MINI-WP-F.....	172	CD-9856M .....	127
32-3119-BU.....	120	AVO-A4-F.....	172	CD-9856MM.....	127
32-3121BU.....	120	AVO-A4-WP-F .....	172	CD-9866S.....	127
32-4003-BU.....	120	AVO-A4-WP110 .....	173	CD-HDVGA.....	129
35-538.....	119	AVO-CLIP-F.....	191	CD-MX15F .....	127
47-10000.....	251	AVO-MIC-F.....	169	CD-MX15M.....	128
47-10070.....	251	AVO-MIC-WP-F.....	169	CD-MX915H .....	128
47-20000 .....	252	AVO-SVA2-F.....	156	CD-MX915HH .....	128
47-20001 .....	252	AVO-SVA2-WP-F .....	157	CD-MX9F.....	126
47-20026.....	252	AVO-USB .....	173	CD-MX9M.....	128
47-20027 .....	252	AVO-V1-PAIR-F.....	155	CEBUS-2N2 .....	75
47-20250 .....	252	AVO-V1-WP-F .....	155	CEBUS-CM-1N1-SIAM .....	76
4FPIOMM10-BO.....	197	AVO-V1A2-F .....	155	CEBUS-F.....	75
4FPIOMM6-BO .....	197	AVO-V1A2-WP-F.....	156	CEBUS+-2N2.....	75
4FRIMM10-BO.....	195	AVO-V1A2-WP110.....	156	CM-206-L.....	248
4FRIOMM10-BO.....	195	AVO-V3AD-F.....	153	CM-23/25 .....	249
4FRIOMM10-D .....	197	AVO-V3AD-WP-F .....	153	CM-23/25-BLADE.....	249
6FRIOMM6-D.....	196	AVO-V3AD-WP110 .....	154	CM-59/6.....	249
6SPDX.....	236	AVO-V3HD-F.....	154	CM-59/6-BLADE .....	249
74-005-01 .....	30	AVO-V3PT-F .....	154	CM-8/11 .....	250
74-005-01 .....	160	AVO-VGA .....	174	CM-A-12.....	139
75-001-01.....	192	AVO-VGA-R.....	174	CM-A-14.....	139
75-520-WH .....	130	AVO-VGA-S .....	175	CM-A-16.....	139
75-629 .....	120	AVO-VGA2-WP .....	173	CM-APAP .....	139
75-699 .....	120	AXLINK .....	40	CM-APBA.....	139
90131LW.....	254	AXLINK-P .....	40	CM-APSL .....	139
95-000-41.....	131	BMHR.....	250	CM-MINI.....	250
95-000-41.....	199	BOOT-S .....	136	CM-MINI-BLADE.....	250
95-000-99.....	131	BOOT-S .....	255	CM-R .....	122
95-000-99.....	199	CAT5E-4C-J.....	76	CM-R.....	249
95-050-41-X .....	131	CCH-01U .....	210	CM-RG11-F .....	130
95-050-41-X .....	199	CCH-02U .....	210	CM-RG59M-BNC.....	121
A681PZA-STP .....	138	CCH-CP06-15T.....	207	CM-RG59M-F .....	130
AC3FI .....	142	CCH-CP06-19T.....	209	CM-RG59M-RCA .....	135
AC3FIB.....	142	CCH-CP06-3C .....	209	CM-RG6L-BNC.....	122
AC3MI .....	142	CCH-CP06-56 .....	207	CM-RG6L-F .....	130
AC3MIB.....	142	CCH-CP06-E6.....	208	CM-RG6L-RCA .....	135
ARDPHD .....	132	CCH-CP06-G6 .....	208	CM-RG6M-BNC.....	122
ARDVHD .....	133	CCH-CP12-15T .....	207	CM-RG6M-F .....	130
ARMCHD .....	132	CCH-CP12-56 .....	207	CM-RG6M-RCA .....	135

CM-RGB23-BNC .....	121	DIGI-HD-XR .....	167	DMM5SCST .....	203
CM-RGB23-F .....	130	DIGI-HD70-R .....	159	DMM5STST .....	203
CM-RGB23-GRCA .....	134	DIGI-HD70-S .....	160	DMM6LCLC .....	201
CM-RGB23-RCA .....	134	DIGI-HDE-R .....	161	DMM6LCSC .....	201
CM-RGB25-BNC .....	121	DIGI-HDE-S .....	161	DMM6LCST .....	201
CM-RGB25-RCA .....	134	DIGI-HDMI-HR .....	169	DMM6SCSC .....	201
CM-RGB25S-BNC .....	121	DIGI-PMK1 .....	163	DMM6SCST .....	202
CM-RGB25S-RCA .....	134	DIGI-PMK1 .....	191	DMM6STST .....	202
CM-RGB26-BNC .....	121	DIGI-SCAL-11X2 .....	187	DSMLCLC .....	205
CM-RGB26-GBNC .....	121	DIGI-SCAL-11X2 .....	188	DSMLCSC .....	205
CM-RGB26-GRCA .....	134	DIGI-SCAL-5 .....	187	DSMLCST .....	206
CM-RGB26-RCA .....	134	DIGI-SCAL-5 .....	188	DSMSCST .....	206
CM-TOOL .....	248	DIGI-USB2 .....	174	DSMSTST .....	206
CM-TOOL-11 .....	250	DIGI-VGA-F .....	151	DVI/VGA .....	126
CM-TOOL-DIE .....	248	DIGI-VGA-F .....	175	E-2RCAM-M .....	86
CM-TOOL-PAC .....	248	DIGI-VGASD2-EMT .....	190	E-2V2AC3 .....	90
CP-8 .....	232	DIGI-VGASD2-EYE .....	190	E-3.5SM-M .....	86
CP-8B .....	233	DIGI-VGASD2-R .....	152	E-3RCAM-M .....	114
CP-8S .....	232	DIGI-VGASD2-R .....	175	E-DB9F-F .....	94
CT .....	258	DIGI-VGASD2-S .....	176	E-DB9F-F-NULL .....	94
CT-P .....	258	DIGI-VGASD2-T4 .....	151	E-DB9M-F .....	94
CT-UV .....	258	DIGI-VGASD2-T4 .....	176	E-DPM-HDF .....	133
D-3RCAM-M .....	91	DIGI-VGASD2-T8 .....	151	E-DVI/A-5BNCF .....	93
D-AV3RCAM-M .....	90	DIGI-VGASD2-T8 .....	176	E-DVI/A-5BNCM .....	93
D-INSTALLKIT-CMP .....	115	DIGIB-EMT .....	190	E-DVI/A-VGAM .....	93
D-VGAM-5BNCF .....	115	DIGIB-EYE .....	190	E-DVIDDL .....	93
D-VGAM-5BNCM .....	115	DIN-RACK-KIT-F .....	191	E-DVIDSL .....	94
D-VGAM-M .....	115	DL-AR .....	132	E-HD-DVI .....	103
DB9F .....	129	DL-CL .....	133	E-HDM-M .....	103
DB9M .....	129	DL-HDCAT-R .....	162	E-HDSEM-M .....	102
DFO-1000P .....	105	DL-HDCAT-S .....	162	E-MDPM-HDF .....	133
DFO-1000P .....	200	DL-HDCAT-WP-R .....	162	E-MHDM-M .....	103
DIGI-DVI-F .....	158	DL-HDCAT-WP-S .....	162	E-MVGAANM-M .....	112
DIGI-HD-1X4 .....	146	DL-HDD12 .....	150	E-MVGAM-F .....	113
DIGI-HD-1X8 .....	146	DL-HDD15 .....	150	E-MVGAM-M .....	112
DIGI-HD-4X4 .....	184	DL-HDMCBL .....	30	E-MVGAMAM-M .....	112
DIGI-HD-4X8 .....	185	DL-HDMCCK .....	30	E-MVGAPM-M .....	113
DIGI-HD-8X8 .....	186	DL-HDMCCK .....	133	E-SVM-2BNCF .....	107
DIGI-HD-COAX2-R .....	147	DL-HDMHT .....	30	E-SVM-2BNCM .....	107
DIGI-HD-COAX2-R .....	159	DL-HDMHT .....	255	E-SVM-M .....	107
DIGI-HD-COAX2-S .....	147	DL-HDR .....	164	E-USBAA .....	108
DIGI-HD-COAX2-S .....	159	DLX-HDSM .....	102	E-USBAAEX .....	108
DIGI-HD-IR3-R .....	164	DMM10LCLC .....	204	E-USBAB .....	108
DIGI-HD-IR3-S .....	164	DMM10LCST .....	204	E-VGAF-5BNCF .....	109
DIGI-HD-IR3-WP-R .....	165	DMM10SCSC .....	204	E-VGAF-5BNCM .....	109
DIGI-HD-IR3-WP-S .....	165	DMM10STSC .....	205	E-VGAM-5BNCF .....	109
DIGI-HD-UHR2-R .....	165	DMM10STST .....	205	E-VGAM-5BNCM .....	110
DIGI-HD-UHR2-S .....	166	DMM5LCLC .....	202	E-VGAM-M .....	109
DIGI-HD-UHR2-WP-R .....	166	DMM5LCSC .....	202	E-VGAMAM-M .....	110
DIGI-HD-UHR2-WP-S .....	166	DMM5LCST .....	203	ELAN-CM-VIA .....	40
DIGI-HD-XR .....	150	DMM5SCSC .....	203	ELZ-09MT .....	129



EZ-BARREL-MM .....	98	ISK .....	231	NC3MXX .....	141
EZ-LINX .....	99	ISK-35S .....	230	NC4FXX .....	141
EZ-LINX-C1 .....	97	ISK-BJ .....	231	NC4MXX .....	141
EZ-LINX-CAP .....	98	ISK-BNC .....	230	NC5FXX .....	141
EZ-LINX-P-25 .....	99	ISK-F .....	230	NC5MXX .....	141
EZ-LINX-P-2V2A-35 .....	98	ISK-SC .....	231	NL2FC .....	140
EZ-LINX-P-C1 .....	98	ISKF-RCAF .....	231	NL4FC .....	140
EZ-VGA3.53RCA-35 .....	97	ISKM-HD .....	230	NP2C .....	118
EZ-VGA3.53RCA-C1 .....	97	K5-8PE .....	232	NP3C .....	118
EZ-VGAM .....	99	K6-8KP .....	232	NP3X .....	118
EZ-VGAMAM .....	99	K6-8KPS .....	232	P-HDM-M-08 .....	105
EZ-VGAMAM-C1 .....	97	KX-6 .....	231	P-HDM-M-10 .....	105
EZ2-2V2A .....	100	LAV-HDTK .....	253	P-HDM-M-15 .....	105
EZ2-2V2A-P .....	100	LITE-TOUCH-MODULE .....	41	P-INSTALLKIT-CMP .....	116
EZ2-FF-P .....	101	LITE-TOUCH-SW .....	41	P20SD-RCAM-M .....	114
EZ2-VAM .....	100	LLINX-CR .....	37	P221P-3.5TRSM-M .....	88
EZ2-VF .....	100	LLINX-D .....	37	P222P-2RCAM-M .....	89
EZ2-VM .....	101	LLINX-HD .....	38	P222P-3.5SM-2RCAM .....	89
FCC-CLEANER-FIBER .....	199	LLINX-Q .....	37	PC-EZ1000 .....	224
FCC-CLEANER-FIBER .....	256	LLINX-QM-P .....	39	PC-EZ1260 .....	224
FCC-WIPES .....	199	LLINX-U .....	37	PC-G1000 .....	225
FCC-WIPES .....	256	LLINX-U-DB .....	38	PC-G1020 .....	225
FLX-8X8A .....	180	LLINX-U-HP .....	38	PC-G1140 .....	226
FLX-8X8A .....	182	LLINX-U-P .....	38	PC-G1240 .....	222
FLX-BI4 .....	183	LUTRON-EBC .....	34	PC-G1260 .....	226
FLX-BO4 .....	183	LUTRON-ESC .....	34	PC-G1300 .....	222
FLX-DI4 .....	183	LUTRON-GRN .....	34	PC-G1320 .....	222
FLX-DO4 .....	183	LUTRON-ORG .....	33	PC-G1350 .....	225
FLX-HI4 .....	182	LUTRON-P-EBC .....	36	PC-G1520 .....	226
FLX-HO4 .....	182	LUTRON-P-ESC .....	36	PC-G1540 .....	226
FLX-RI4 .....	182	LUTRON-P-GRN .....	36	PC-G1600 .....	226
G-2V2A-B1 .....	111	LUTRON-P-QSC .....	36	PC-G1620 .....	226
G-2V2A-C3-45DEG .....	112	LUTRON-P-RBL .....	35	PC-G1660 .....	225
G-VGAM-F .....	111	LUTRON-P-RED .....	35	PC-G1720 .....	227
G-VGAM-M .....	111	LUTRON-P-YEL .....	35	PC-G1760 .....	225
G-VGAMAM-M .....	111	LUTRON-PNK .....	32	PC-G1765 .....	227
HD-1000 .....	104	LUTRON-QSC .....	34	PC-G1790 .....	224
HD-4X1 .....	188	LUTRON-RBL .....	33	PC-G1795 .....	225
HD-600 .....	104	LUTRON-RED .....	33	PC-G1800 .....	223
HD-700 .....	104	LUTRON-WHT .....	32	PC-G1900 .....	222
HD-TG .....	192	LUTRON-YEL .....	33	PC-G1920 .....	222
HDMH90F .....	133	LV1 .....	233	PC-G1940 .....	223
HSK-2:1-1/2 .....	256	LV2 .....	233	PC-G1960 .....	223
HSK-2:1-1/4 .....	256	LV3 .....	234	PC-G2000 .....	227
HSK-2:1-1/8 .....	257	LVMB1 .....	234	PC-G2020 .....	227
HSK-2:1-3/16 .....	257	LVMB2 .....	234	PC-G2120 .....	227
HSK-2:1-3/8 .....	257	MB-DM .....	234	PC-G2320 .....	222
HTR05-1U .....	238	MB-SM .....	234	PC-G2900 .....	223
ICCB10-1 .....	258	MHDTZK9K .....	129	PC6B .....	92
ICCB12-2 .....	258	MHR-BNC .....	124	PCD-5000 .....	223
INTERFLEX-SD .....	27	NC3FXX .....	141	PCD-5100 .....	223

PCD-5280.....	224	SKYPLAY-HD-R.....	170	VGA-HD.....	187
PCD-5750.....	224	SKYPLAY-HD-S.....	149	VGA2-DA4.....	152
PCD-5850.....	224	SKYPLAY-HD-S.....	170	VGA2-HR.....	177
PCE5B.....	92	SMART1500RML2UA.....	236	VGA2-SW4.....	189
PPCE5B.....	92	SMART500RT1U.....	236	VGA2-UHR.....	177
PPEDHS-15F.....	128	SPH-01P.....	210	VGA90U.....	126
PPEDHS-15P.....	128	SQ-XLRM-F.....	86	VGADA-2.....	152
PRG59-RCAM-M.....	116	SR-B.....	243	WCH-02P.....	210
QUADFLEX-BC.....	59	SR-BPHS1.....	244	WCH-04P.....	210
QUADFLEX-SIAM.....	60	SR-BPHS2.....	245	WJ-DEC.....	228
RF-F.....	153	SR-BPS1.....	244	WJ-DEC4.....	228
RG11-BC-CATV-DB.....	59	SR-BPS2.....	245	WJ-DEC6.....	228
RG11-CATV.....	58	SR-BPS3.....	245	WJ-DECHD1.....	229
RG11-P-CATV.....	61	SR-DR3.....	243	WJ-DECHD2KJ.....	229
RG11-QUAD-PL.....	60	SR-LB.....	244	WP-DEC2.....	228
RG58-CMP.....	78	SR-QFD2-4.....	243	WP-DEC3.....	228
RG58-CMR.....	77	SR-SH1.....	245	WP-N1.....	229
RG59-18/2C-PS.....	16	SR-SH2.....	246	WP-N12.....	229
RG59-CCTV-CM.....	12	SR-SH3.....	246	WP-N2.....	229
RG59-CCTV-PL.....	16	SR-SHS1.....	246	WP-N3.....	229
RG59-DB-CCTV.....	12	SR-T.....	243	WP-N4.....	230
RG59CM-18-2C.....	13	SR14.....	241	WP-N6.....	230
RG6-BC-CATV-DB.....	59	SR21.....	241	Z100A.....	87
RG6-CATV-DB.....	60	SR29.....	241	Z100AM.....	86
RG6-CCTV-CM.....	12	SR37.....	242	Z100AV.....	90
RG6-CCTV-PL.....	16	SR43.....	242	Z100AY.....	87
RG6-CM.....	59	SR43-26.....	242	Z100VGA.....	110
RG6-P-CATV.....	61	SR43-K1HP.....	242	Z100VGAA.....	110
RG6-QUAD-CMP.....	61	SR43-R.....	244	Z200A.....	87
RG6-QUAD-DB.....	58	SV-PLN.....	14	Z200AV.....	90
RG8-CMP.....	78	TEKTONE-AUDIO.....	42	Z200FM.....	87
RG8-CMR.....	77	TEKTONE-D2.....	42	Z200MF.....	88
RGB3C-23-CM.....	13	TEKTONE-NC300-500.....	43	Z200MM.....	88
RGB3C-25-CM.....	13	TEKTONE-P2.....	42	Z250A.....	88
RGB5-MINI.....	12	TEKTONE-PLN-AUDIO.....	42	Z250CV.....	114
RGB5C-20-CMR.....	11	TEKTONE-PLN-BUNDLE.....	43	Z500NTOS.....	95
RGB5C-23-CM.....	10	TEKTONE-PLN-DATA.....	43	ZB01.....	140
RGB5C-23-CMP.....	14	TEKTONE-PLN-POWER.....	43	ZB02.....	140
RGB5C-25-CM.....	11	TF-PET-75.....	257	ZB03.....	140
RGB5C-25-CMP.....	15	TF-PET-1.25.....	257	ZB04.....	140
RGB5C-PLN.....	15	TKT-UNICAM-PFC.....	198	ZD01.....	135
RGB5C-PVC.....	11	TKT-UNICAM-PFC.....	199	ZD03.....	135
RGB6C-23-2L5E.....	75	TKT-UNICAM-PFC.....	256	ZD05-SLM.....	138
RGB6C-25/22-2P-CMP.....	15	TRUPHASE.....	10	ZD06.....	135
RGB6C/22-2P.....	11	TRUPHASE-P.....	14	ZTOS.....	95
RGB6C/22-2P-PLN.....	16	UL620-15.....	237		
S-V1CP.....	157	UWGD0000.....	233		
S-V1P-R.....	157	UWGS0000.....	233		
S-V1P-T.....	158	V21.....	125		
S-V1ST.....	158	V5.....	125		
SKYPLAY-HD-R.....	149	V99.....	126		



**BARGAIN BIN!**  
**PRICES DROP DAILY**  
 Check back daily for lower  
 prices on overstock items!  
[www.LibAV.com](http://www.LibAV.com)

# BETTER, STRONGER, EXPANSIVE!

Liberty's brand new expansive website has all of the complete information and tools you need to easily research and get what you need for your next profitable installation job.

[www.LibAV.com](http://www.LibAV.com)



**RUN WITH US**  
[www.LibAV.com](http://www.LibAV.com) | 800.530.8998

- Keep all of your custom information and part numbers in a **password-protected area**
- Utilize our **Learning Center** for training videos, white papers and online product info
- Find complete, **up-to-date specs**, information and cross reference
- Check out our **super high-res product photography** & download any image you need
- Download any of our **literature** including our catalog, sell sheets & application brochures
- Find great deals on closeout items in our **Bargain Bin**, where prices drop daily
- Easily find our newest products right on the front page in our **Product Showcase**



**LIBERTY  
AV SOLUTIONS**

A SUBSIDIARY OF WESCO DISTRIBUTION, INC.

# RUN WITH US

L13.1

## **HEADQUARTERS**

11675 Ridgeline Drive  
Colorado Springs,  
Colorado  
80921 USA  
Phone: 719-260-0061  
Fax: 719-260-0075  
Toll-Free: 800-530-8998  
Order E-Mail:  
orders@libertycable.com

## **EAST COAST OFFICE AND WAREHOUSE FACILITY**

5521 Lakeview Rd. Suite W  
Charlotte, North Carolina  
28269 USA  
Phone: 719-260-0061  
Fax: 719-260-0075  
Toll-Free: 800-530-8998  
Order E-Mail:  
orders@libertycable.com

## **PANELCRAFTERS DIVISION**

4219 East Broadway Rd.  
Suite 102  
Phoenix, Arizona  
85040 USA  
Phone: 602-438-7100  
Fax: 602-437-1182  
Toll-Free: 800-263-6591  
Email:  
sales@panelcrafters.com

## **INTELIX DIVISION**

8001 Terrace Av.  
Suite 201  
Middleton, Wisconsin  
53562 USA  
Phone: 608-831-0880  
Fax: 608-831-1833  
Toll-Free: 866-462-8649  
Email:  
intelix@intelix.com